



*Buckeye*

**HARDWARE**

DISTRIBUTING, LTD.

2021 Catalog

**Amerock**

## TABLE OF CONTENTS

▪ Abrasives	221
▪ Adhesives	208
▪ Amana Tools	217
▪ Amerock	3
▪ Bedroom	154
▪ Belwith Keeler	79
▪ Chest Hardware	148
▪ Drivers – Hanger Bolts	211
▪ Elements	125
▪ Euro Hinges	172
▪ Fasteners	162
▪ Glides	152
▪ Grass	163
▪ H Select	49
▪ Ice Box and Table	157
▪ Index	230
▪ Jeffrey Alexander	91
▪ Kitchen	180
▪ KREG	205
▪ Lighting, Power and Media	191
▪ Mini Barn Door Hardware	147
▪ Mirror Parts - Bumpers	161
▪ Office and Living Room	155
▪ Rev•A•Shelf	185
▪ Screws	212
▪ Sewing Machine Parts and Casters	151
▪ Shelf Supports	160
▪ Slides	156,177
▪ Sliding Door	146
▪ Staplers – Nailers	219
▪ Staples – Nails	220
▪ Stretch Film	210
▪ Table Slides – Pöttker	144
▪ Wood Filler	206
▪ Wood Handles	71
▪ Wood Knobs	69
▪ Wood Products	198

## INFORMATION

### WAREHOUSE LOCATION

1465 Twp Rod 178  
Baltic, OH 43804

### WAREHOUSE HOURS

Monday - Friday 6:30 AM - 3:00 PM

### FAX ORDER LINE

330-897-0022

### PHONE

330-897-0017

844-303-0017

### INDIANA SALES

Ervin Miller 260-593-0225

Weekly delivery to Northern Indiana

### RETURNS

Within 30 days, 5% restocking fee

After 30 days, 20% restocking fee

Must Include Invoice Number

### SHIPPING CHARGES

\$12.00 for orders under \$100

\$15.00 for \$100 - \$400

\$18.00 for \$400 - \$600

\$25.00 for \$600 - \$1500

Over \$1500 free shipping

PRICES SUBJECT TO CHANGE WITHOUT NOTICE

**Amerock®**



FULL LINE MASTER DISTRIBUTOR OF AMEROCK  
THIS PAGE FOR COLOR REFERENCE ONLY

SILVER TONES



**26, CH**  
POLISHED CHROME



**PN**  
POLISHED NICKEL



**G10, SN**  
SATIN NICKEL (MATTE)



**SC**  
SILVER CHAMPAGNE



**G9**  
STERLING NICKEL



**S**  
SILVER



**G10**  
SATIN NICKEL



**14**  
NICKEL



**SS**  
STAINLESS STEEL



**AA**  
ANODIZED ALUMINUM



**26D, SCH**  
BRUSHED CHROME



**BBN**  
BLACK BRUSHED NICKEL



**BCR**  
BLACK CHROME



**AS**  
ANTIQUÉ SILVER



**AP**  
AGED PEWTER



**AN**  
ANTIQUÉ NICKEL



**WN**  
WEATHERED NICKEL



**WNC**  
WEATHERED NICKEL COPPER

GOLD TONES



**CZ**  
CHAMPAGNE BRONZE



**BBZ**  
BRUSHED BRONZE OR GOLDEN CHAMPAGNE



**3, PB**  
POLISHED BRASS



**GB**  
GILDED BRONZE



**AE**  
ANTIQUÉ ENGLISH



**EB**  
ELEGANT BRASS



**O77, BB**  
BURNISHED BRASS



**AB, ABS**  
ANTIQUÉ BRASS



**DBS**  
DISTRESSED BRASS



**R1**  
REGENCY BRASS



**R2**  
WEATHERED BRASS



**R3**  
RUSTIC BRASS



THIS PAGE FOR COLOR REFERENCE ONLY

**BOLD TONES**



**AC**  
ANTIQUÉ COPPER



**BC**  
BRUSHED COPPER



**WC**  
WEATHERED  
COPPER



**RBZ**  
RUSTIC BRONZE



**CBZ**  
CARMEL BRONZE



**ART**  
ANTIQUÉ RUST



**VS**  
VIRIDIAN SLATE



**RB**  
ROMAN BRONZE



**VB**  
VENETIAN  
BRONZE



**ORB**  
OIL-RUBBED  
BRONZE



**DOB**  
DARK OILED  
BRONZE

**BLACK TONES**



**WI, WID**  
WROUGHT IRON  
OR WROUGHT  
IRON DARK



**PWT**  
PEWTER



**GM**  
GUNMETAL



**GPH**  
GRAPHITE



**BN, BNB**  
BLACK NICKEL



**BBR**  
BLACK BRONZE



**FB**  
FLAT BLACK



**CB**  
COLONIAL BLACK



**MB**  
MATTE BLACK

**MISCELLANEOUS TONES**



**30, W, 54, GW**  
WHITE



**MW**  
MARBLE WHITE

EVERYDAY HERITAGE

**3423-BB**  
 | 1/2" DIA  
 | 1" PROJ

BB

**3433-AC**  
 | 1/2" DIA  
 | 15/16" PROJ

AC

**594-AE**  
 | 1/2" DIA  
 | 7/8" PROJ

AE

**3413-26**  
 | 1/2" DIA  
 | 5/8" PROJ

3 26

**3414-3**  
 | 3/4" DIA  
 | 3/4" PROJ

3

**29112-CS**  
 | 3/16" DIA  
 | 1/4" PROJ

CS

**29113-G10**  
 | 1/4" DIA  
 | 3/4" PROJ

ORB G10

**29115-G10**  
 | 1/2" DIA  
 | 1/8" PROJ

G10

**29116-G10**  
 | 3/16" DIA  
 | 3/4" PROJ

G10

**53000-G10**  
 | 1/4" DIA  
 | 7/8" PROJ

G10

**53002-G10**  
 | 3/16" DIA  
 | 1" PROJ

ORB G10

**53011-G10**  
 | 1/4" DIA  
 | 1/8" PROJ

FB ORB G10 26

**53015-G10**  
 | 1/4" DIA  
 | 1" PROJ

FB ORB G10 26

**53016-26**  
 | 1" C/C  
 | 3/4" L

G10

**53021-G10**  
 96MM C/C | 4 1/4" L

G10

**53022-G10**  
 | 1/4" DIA  
 | 1/8" PROJ

G10

**149-ORB**  
 | 1/4" L  
 | 15/16" PROJ

ORB

**1443-ORB**  
 | 1/4" L  
 | 3/4" PROJ

ORB

**53018-G10**  
 | 3/8" L  
 | 1/2" PROJ

FB ORB G10 26

**53470-ORB**  
 3" C/C | 3 3/4" L

ORB EB G10 26

**53471-ORB**  
 32MM DIA  
 | 3 1/4" PROJ

ORB WN G10

**1910-G10**  
 | 1/4" DIA  
 | 1/8" PROJ

G10

**3401-CB**  
 3 1/4" C/C | 5 1/16" L

CB

**3403-CB**  
 | 1/4" DIA  
 | 3/4" PROJ

CB

**4476-G10**  
 40MM L  
 | 7/8" PROJ

FB G10

**53004-ORB**  
 96MM C/C  
 4 3/4" L

ORB BB G10

**53001-ORB**  
 | 1/4" DIA  
 | 7/8" PROJ

FB ORB



EVERYDAY HERITAGE



**173-ORB**  
3" C/C | 4 5/8" L



**29111-G10**  
128MM C/C | 6" L



**174-ORB**  
3" C/C | 5 1/16" L

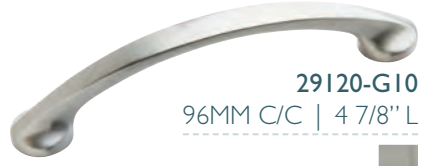

**29120-G10**  
96MM C/C | 4 7/8" L



**253-ORB**  
3" C/C | 4 7/8" L

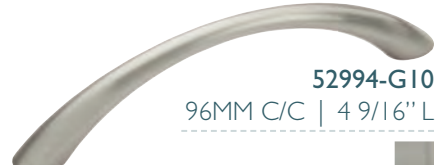

**52994-G10**  
96MM C/C | 4 9/16" L



**1908-G10**  
3" C/C | 5 1/2" L



**52995-G10**  
96MM C/C | 5" L



**53006-G10**  
3" C/C | 3 3/8" L



**4478-G10**  
96MM C/C | 4" L

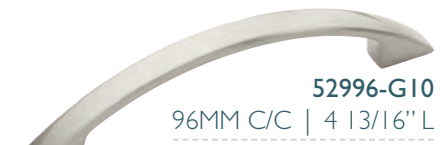

**52996-G10**  
96MM C/C | 4 13/16" L



**4479-G10**  
96MM C/C | 4 7/16" L



**69153-G10**  
3" C/C | 4" L



**3415-26**  
2 3/4" C/C | 3 1/2" L



**3416-26**  
3" C/C | 4" L



**3441-3**  
3" C/C | 3 3/8" L







**ABERNATHY**



AVAILABLE FINISHES



CG10 CAS CORB

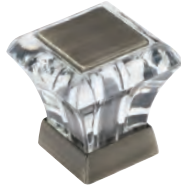

**29460-CAS**  
1" L | 1" PROJ

**ALOFT**



AVAILABLE FINISHES



BCR G10 PN 26



**36743-BCR**  
4 13/16" C/C | 5 13/16" L



**36744-BCR**  
4 9/16" C/C | 7 3/4" L



**36745-BCR**  
6 9/16" C/C | 9 3/4" L



**36746-BCR**  
8 9/16" C/C | 11 11/16" L

**APPOINT**



AVAILABLE FINISHES



FB ORB CZ 26 G10



**36758-CZ**  
1 1/4" DIA | 1" PROJ



**36762-CZ**  
76MM C/C | 4 7/8" L



**36763-CZ**  
128MM C/C | 7 7/16" L



**36759-CZ**  
96MM C/C | 4 9/16" L



**36760-CZ**  
128MM C/C | 5 13/16" L



**36761-CZ**  
192MM C/C | 8 5/16" L

AVAILABLE FINISHES



36640-GM  
76MM C/C | 5 1/8" L

ASHBY



ATHERLY



29310-ORB  
1 3/16" DIA | 1 1/8" PROJ



ORB AS G10



29305-AS  
1 1/2" DIA | 1 1/8" PROJ



AS



29280-ORB  
1 1/2" L | 7/8" PROJ



ORB AS G10



29304-ORB  
1 7/8" L | 7/8" PROJ



G10



29289-ORB  
3" C/C | 4 1/4" L



ORB AS G10



29295-ORB  
96MM C/C | 5" L

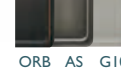

ORB AS G10



29303-ORB  
5 1/16" C/C | 6 1/4" L



ORB AS G10

BAR PULLS



19010-SS  
3" C/C | 5 3/8" L



CSG9 SS



19011-SS  
96MM C/C | 6 1/8" L



CSG9 SS



19541-SS  
128MM C/C | 7 3/8" L



CSG9 SS



19012-SS  
192MM C/C | 9 15/16" L



CSG9 SS



19013-SS  
256MM C/C | 13 1/4" L



CSG9 SS



**BAR PULLS**



 <b>19009-ORB</b> 2" L   1 3/8" PROJ  BBR ORB GM BBZ CSG9 SS PN	 <b>40515-CBZ</b> 3" C/C   5 3/8" L  BBR ORB CBZ GM BBZ PN	 <b>40516-ORB</b> 96MM C/C   6 1/8" L  BBR ORB GM BBZ PN
 <b>40517-ORB</b> 128MM C/C   7 3/8" L  BBR ORB CBZ GM BBZ PN	 <b>40518-ORB</b> 192MM C/C   9 7/8" L  BBR ORB GM BBZ PN	 <b>40519-ORB</b> 256MM C/C   13 1/4" L  BBR ORB GM BBZ PN
 <b>54008-BBZ</b> 12" C/C   14 5/8" L  BBR ORB GM BBZ CSG9 SS PN	 <b>19014-ORB</b> 320MM C/C   15 3/4" L  BBR ORB GM BBZ CSG9 SS PN	
 <b>19015-ORB</b> 416MM C/C   19 1/2" L  ORB CSG9 SS	 <b>54025-SS</b> 18" C/C   20 5/8" L  BBR ORB BBZ SS PN	
 <b>19016-ORB</b> 480MM C/C   22" L  BBR ORB GM BBZ CSG9 SS PN		
 <b>19017-ORB</b> 544MM C/C   24 9/16" L  ORB CSG9 SS		
 <b>19018-ORB</b> 640MM C/C   28 3/8" L  ORB CSG9 SS		
 <b>19019-ORB</b> 768MM C/C   33 3/8" L  ORB CSG9 SS		

BLACKROCK

AVAILABLE FINISHES



BLYPHE



**BRASS CLASSICS**



**1950-G10**  
1 1/4" DIA  
1" PROJ



**1950H-G10**  
1 1/4" DIA  
1" PROJ



**1466-ORB**  
1 1/4" DIA  
1 1/16" PROJ



**BRASS WIRE PULLS**



**865-26D**  
3" C/C | 3 5/16" L



**76312-26D**  
4" C/C | 4 1/4" L



**867-CS26D**  
3 1/2" C/C | 3 13/16" L



**76313-26D**  
4" C/C | 4 1/4" L



**CALIBER**

AVAILABLE FINISHES



**36873-ORB**  
96MM C/C | 5 7/8" L



**36874-ORB**  
128MM C/C | 7 1/8" L



**36875-ORB**  
160MM C/C | 8 7/16" L



**36876-ORB**  
192MM C/C | 9 11/16" L



**36877-ORB**  
256MM C/C | 12 3/16" L



**36872**  
1 1/4" DIA | 1 3/16" PROJ



CANDLER

AVAILABLE FINISHES



**29340-BBZ**  
1 1/4" L | 1 1/8" PROJ



**29368-BBZ**  
1 1/2" L | 1 1/4" PROJ



**29365-BBZ**  
8" C/C | 9 7/8" L



**29349-BBZ**  
3" C/C | 4 3/8" L



**29355-BBZ**  
96MM C/C | 5 1/8" L



**29363-BBZ**  
128MM C/C | 6 1/2" L



**29364-BBZ**  
160MM C/C | 8" L



**29366-BBZ**  
12" C/C | 14 5/8" L



**29367-BBZ**  
18" C/C | 20 3/4" L



AVAILABLE FINISHES



CAROLYNE



**36580-PN**  
1 3/8" DIA | 1 1/16" PROJ



**36582-G10**  
1 1/4" L  
1 1/16" PROJ



**36584-PN**  
3 3/4" C/C | 5 9/16" L



**36585-PN**  
5 1/16" C/C | 6 13/16" L



CARRIONE

AVAILABLE FINISHES



**36647-MW/BBZ**  
2 1/2" L | 1 9/16" PROJ

**36648-MW/BBZ**  
3 3/4" C/C | 6 5/16" L

**36649-MW/BBZ**  
5 1/16" C/C | 7 1/2" L

**36650-MW/BBZ**  
6 5/16" C/C | 8 3/4" L

CLASSICS



**771-WN**  
1 5/16" DIA  
1 1/4" PROJ



**772-WN**  
1 5/16" DIA  
1 1/4" PROJ



CONRAD

AVAILABLE FINISHES

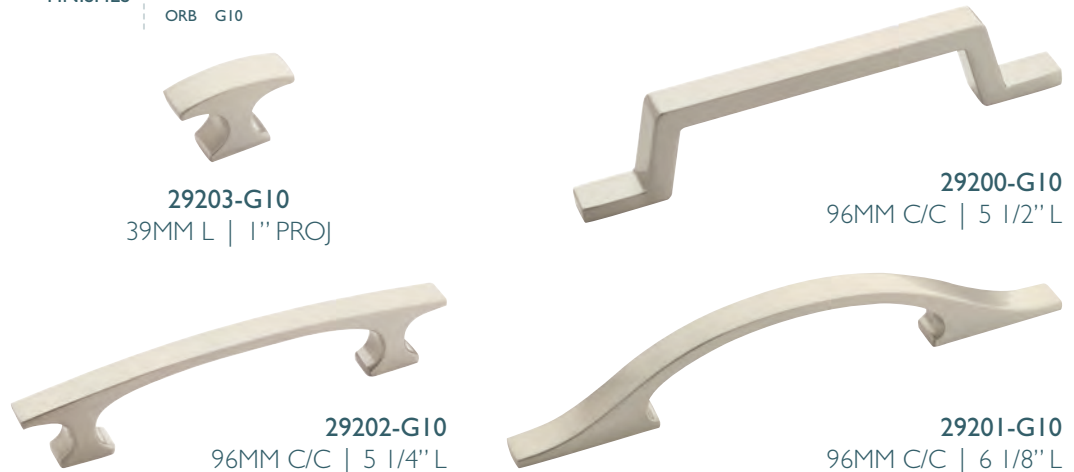

**29203-G10**  
39MM L | 1" PROJ

**29200-G10**  
96MM C/C | 5 1/2" L

**29202-G10**  
96MM C/C | 5 1/4" L

**29201-G10**  
96MM C/C | 6 1/8" L

**CRAWFORD**

AVAILABLE FINISHES



**36593-BBZ**  
3 3/4" C/C | 4 11/16" L



**36594-BBZ**  
5 1/16" C/C | 6 1/16" L



**36595-BBZ**  
6 5/16" C/C | 7 3/8" L



**36613-BBZ**  
1 3/8" DIA | 1 3/16" PROJ



**36616-BBZ**  
1 3/4" DIA | 1 3/8" PROJ



AVAILABLE FINISHES



**CREASED BOW**



**27018-G10**  
7/8" L | 1" PROJ



**27016-G10**  
96MM C/C | 4 3/8" L



**27017-G10**  
128MM C/C | 5 7/8" L



**CROSLEY**



**53704-ORB**  
3" C/C | 3 1/4" L

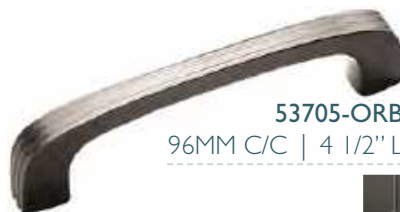

**53705-ORB**  
96MM C/C | 4 1/2" L



**CUP PULLS**



**9365-ORB**  
64MM C/C | 4 1/8" L



**53019-G10**  
2 1/2" C/C | 3 1/8" L



**53010-G10**  
3" C/C | 3 3/8" L

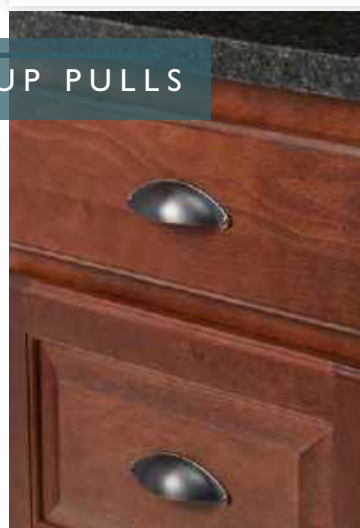



CYPRUS

AVAILABLE FINISHES



**26201-BBZ**  
3" C/C | 5 1/4" L

**26203-BBZ**  
96MM C/C | 6 9/16" L

**9362-BBZ**  
128MM C/C | 7 3/16" L

**26204-BBZ**  
160MM C/C | 9 1/8" L

**26205-BBZ**  
8" C/C | 12" L

**26206-BBZ**  
12" C/C | 16" L

**26207-BBZ**  
18" C/C | 22" L

DAVENPORT

AVAILABLE FINISHES



**36601-ORB**  
1 1/4" L | 1 3/16" PROJ



**36602-ORB**  
1 1/2" L | 1 3/8" PROJ



**36605-ORB**  
3 3/4" C/C | 5 5/16" L



**36606-ORB**  
5 1/16" C/C | 6 9/16" L



**36607-ORB**  
6 5/16" C/C | 7 13/16" L

AVAILABLE FINISHES



**36858-G10**  
96MM C/C | 4 15/16" L



**36859-G10**  
128MM C/C | 6 3/16" L



**36860-G10**  
160MM C/C | 7 7/16" L



**36861-G10**  
224MM C/C | 9 15/16" L



**36857-G10**  
1 3/8" L | 1" PROJ

DESTINE



**5261-PWT**  
1 1/4" DIA  
1 3/8" PROJ



PWT



**5260-G9**  
3" C/C | 4 3/4" L



PWT G9



**19257-G10**  
1 1/4" DIA  
1 5/16" PROJ



G10 26



**19258-G10**  
3" C/C | 1 1/4" L



G10 26

DIVINITY



AVAILABLE FINISHES

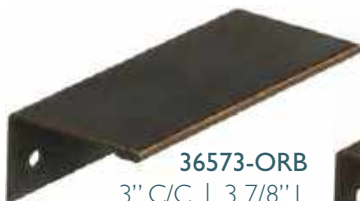

**36573-ORB**  
3" C/C | 3 7/8" L

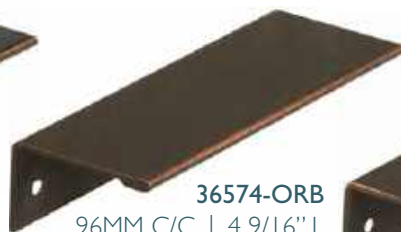

**36574-ORB**  
96MM C/C | 4 9/16" L



**36575-ORB**  
128MM C/C | 5 13/16" L

EDGE PULLS



**EDONA**

AVAILABLE FINISHES



**53005-CZ**  
1 1/4" DIA | 1 1/8" PROJ

**ERA**

AVAILABLE FINISHES

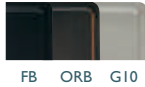

**36907-G10**  
1 1/4" DIA | 1 1/8" PROJ

**ESQUIRE**

AVAILABLE FINISHES



**36556-G10ORB**  
2 5/8" L | 1 1/2" PROJ



**36557-G10ORB**  
3" C/C | 4 11/16" L



**36558-G10ORB**  
128MM C/C | 5 15/16" L



**36559-G10ORB**  
160MM C/C | 7 3/16" L



**36560-G10ORB**  
256 MM C/C | 11" L



**36561-G10ORB**  
320MM C/C | 13 1/2" L

AVAILABLE FINISH



G10



**19200-G10**  
128MM C/C | 5 9/16" L

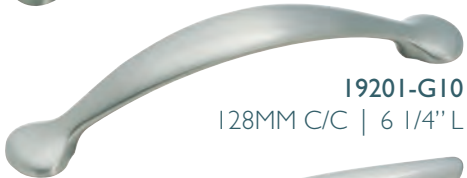

**19201-G10**  
128MM C/C | 6 1/4" L



**19203-G10**  
128MM C/C | 6" L

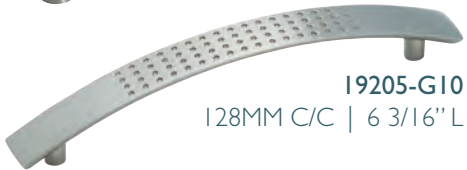

**19205-G10**  
128MM C/C | 6 3/16" L



**19259-G10**  
3" C/C | 4 1/2" L

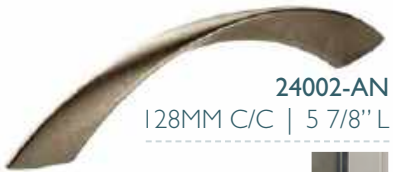

**24002-AN**  
128MM C/C | 5 7/8" L



AN SN



**24001-WNC**  
40MM DIA  
1 1/8" PROJ



WNC



**29409-G10**  
3" C/C | 4 3/8" L

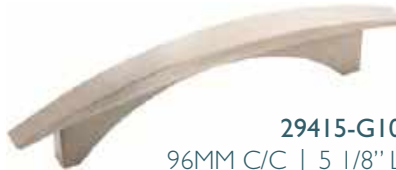

**29415-G10**  
96MM C/C | 5 1/8" L



**29416-G10**  
128MM C/C | 6 3/8" L



**29423-G10**  
160M C/C | 7 5/8" L



**24017-SN**  
160MM C/C | 6 3/4" L



SN



**24018-SN**  
96MM C/C | 4 1/8" L



SN



**ESSENTIAL'Z STAINLESS STEEL**

AVAILABLE FINISH



SS



**19001-SS**  
3" C/C | 3 5/8" L



**19002-SS**  
96MM C/C | 4 9/16" L

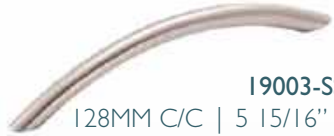

**19003-SS**  
128MM C/C | 5 15/16" L

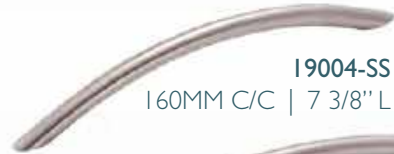

**19004-SS**  
160MM C/C | 7 3/8" L



**19005-SS**  
192MM C/C | 8 7/8" L



**19008-SS**  
1 1/4" DIA  
1 1/8" PROJ



**26200-SS**  
32MM DIA  
1" PROJ



**26202-SS**  
96MM C/C | 4 3/8" L



**24015-SS**  
128MM C/C | 5 5/8" L

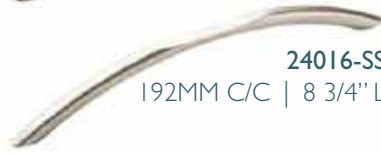

**24016-SS**  
192MM C/C | 8 3/4" L



**24013-SS**  
128MM C/C | 5 9/16" L



SS SN

**EXCEED**



AVAILABLE FINISHES



FB CZ G10 26



**36881-CZ**  
96MM C/C | 5 1/4" L



**36882-CZ**  
128MM C/C | 6" L



**36883-CZ**  
160MM C/C | 7 1/4" L



**36884-CZ**  
224MM C/C | 9 13/16" L



**36880-CZ**  
1 1/2" DIA | 1 3/16" PROJ

EXTENSITY

AVAILABLE FINISHES



29379-G10  
3" C/C | 4 1/8" L



29370-G10  
1 3/16" L  
1 1/16" PROJ



29398-G10  
1 1/2" L  
1 1/8" PROJ

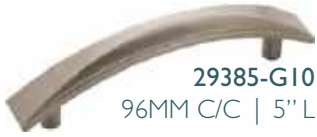

29385-G10  
96MM C/C | 5" L



29395-G10  
8" C/C | 9 1/4" L



29393-G10  
128MM C/C | 6 1/4" L

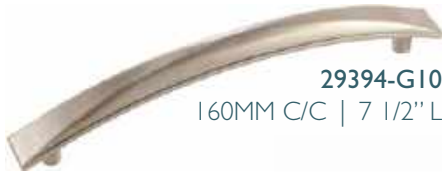

29394-G10  
160MM C/C | 7 1/2" L



29396-G10  
12" C/C | 13 1/4" L



29397-G10  
18" C/C | 19 3/16" L



AVAILABLE FINISHES



36750-BCR  
4 13/16" C/C | 5 13/16" L



36751-BCR  
4 9/16" C/C | 7 3/4" L



36752-BCR  
6 9/16" C/C | 9 3/4" L



36753-BCR  
8 9/16" C/C | 11 11/16" L

EXTENT



EYDON



**53036-WNC**  
3" C/C | 3 5/8" L  
ORB



**53035-WNC**  
1" DIA  
1 1/4" PROJ  
ORB WNC



**53037-WNC**  
96MM C/C | 4 4/9" L  
WN WNC

FACTOR

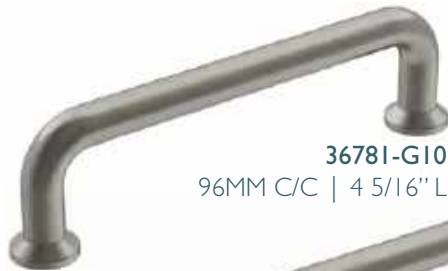

**36781-G10**  
96MM C/C | 4 5/16" L



**36780-G10**  
1 1/4" DIA | 1 1/16" PROJ



**36782-G10**  
128MM C/C | 5 9/16" L



**36782-G10**  
128MM C/C | 8 1/8" L

FORGINGS



4424-WI  
3" C/C | 4 1/8" L



4425-WI  
1 1/4" DIA  
1 1/8" PROJ



4426-RBZ  
3" C/C | 4" L



4427-WI  
1 1/4" DIA  
1" PROJ



4428-WI  
3" C/C | 4 1/8" L



4429-WI  
1 1/8" L  
1 1/8" PROJ



AVAILABLE FINISHES



36654-CGM  
3 3/4" C/C | 5 5/16" L



36655-CGM  
5 1/16" C/C | 6 9/16" L



36656-CGM  
6 5/16" C/C | 7 7/8" L



36651-CGM  
1 3/4" L | 1 3/16" PROJ



36652-CGM  
1 3/8" L | 1" PROJ



36653-CGM  
1 3/8" L | 1 5/16" PROJ



GLACIO



GRACE REVITALIZE

AVAILABLE FINISHES



BBR ORB BBZ G10 PN



**36628-BBZ**

1 3/8" DIA | 1 3/16" PROJ



**36629-BBZ**

1 3/4" DIA | 1 3/8" PROJ

GRANBY



**53013-ORB**

3" C/C | 3 3/8" L



FB BN ORB G10 PN 26



**55243-ORB**

96MM C/C | 4 1/5" L



FB ORB G10 PN 26



**55244-ORB**

128MM C/C | 5 1/2" L



FB ORB G10 PN 26



**55245-ORB**

160MM C/C | 6 7/8" L



FB ORB G10 PN 26



**55246-ORB**

8" C/C | 8 2/3" L



ORB G10



**55247-ORB**

12" C/C | 12 2/3" L



ORB G10



**55248-ORB**

18" C/C | 18 15/16" L



ORB G10

HARMONY

AVAILABLE FINISH



G10



**29439-G10**

3" C/C | 3 11/16" L

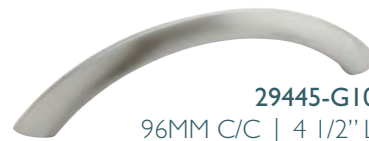

**29445-G10**

96MM C/C | 4 1/2" L



**29446-G10**

128MM C/C | 5 7/8" L

330-897-0017



Fax Order 330-897-0022

AVAILABLE FINISHES



BBR DOB CBZ AP BBZ G10 PN



55311-PN

35MM L | 1 1/7" PROJ



BBR DOB AP BBZ G10 PN



55312-PN

28MM DIA | 1 1/5" PROJ



55315-PN

1 3/8" L

1 5/16" PROJ



DOB AP PN



55316-PN

3" C/C | 4 1/3" L



55317-PN

96MM C/C | 5 1/6" L



55319-PN

128MM C/C | 6 2/3" L



BBR DOB AP BBZ G10 PN



55321-PN

160MM C/C | 8 4/7" L



55322-PN

8" C/C | 10 1/2" L



BBR DOB AP BBZ G10 PN

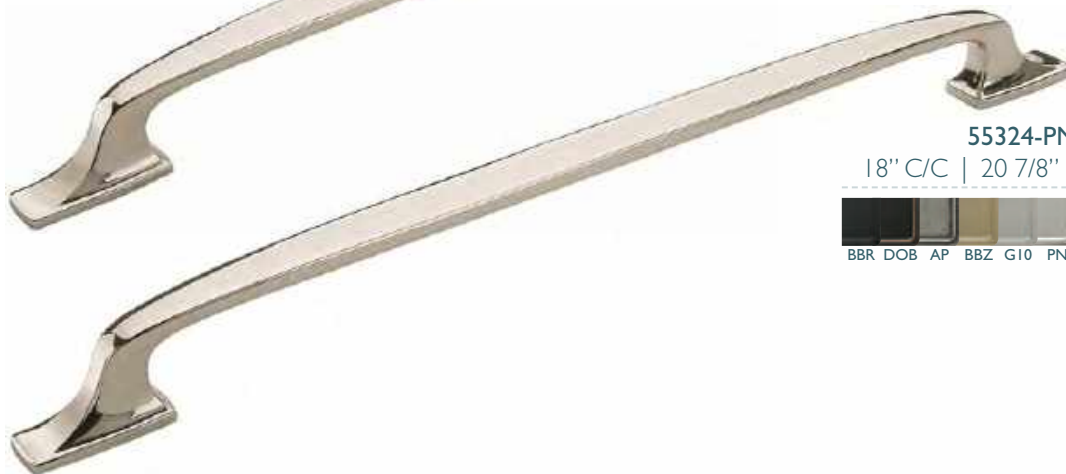

55323-PN

12" C/C | 15 1/3" L



BBR DOB AP BBZ G10 PN

55324-PN

18" C/C | 20 7/8" L



BBR DOB AP BBZ G10 PN



INSPIRATIONS



**1585-FB**  
1 1/4" DIA  
1" PROJ

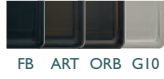

FB ART ORB G10



**1584-FB**  
3" C/C | 4 1/8" L



FB ORB G10



**1784-ORB**  
96MM C/C | 4 7/8" L



ORB G10



**1785-ORB**  
128MM C/C | 6 1/8" L



ORB G10



**1786-ORB**  
160MM C/C | 7 3/8" L



ORB G10



**1586-CBZ**  
1 3/8" DIA  
1" PROJ



FB ORB ART WID WN G10



**1586-2-CBZ**  
1 3/4" DIA  
1 1/4" PROJ



FB CBZ ORB VB WN G10



**1590-CBZ**  
3" C/C | 5 5/8" L



FB ORB ART WID WN G10



**1587-CBZ**  
96MM C/C | 6 5/16" L



FB ORB WN G10



**1588-G10**  
128MM C/C | 7 1/2" L



FB ORB WN G10



**1589-G10**  
160MM C/C | 8 3/4" L



FB ORB WN



**1592-ORB**  
3" C/C | 4 1/4" L



FB ORB WID G10



**1593-ORB**  
1 7/8" L | 1 1/16" PROJ



FB ORB G10

AVAILABLE FINISHES



**53700-WN**  
1 1/4" DIA | 1 1/4" PROJ



**53807-2-WN**  
1 5/8" DIA | 1 1/2" PROJ



**53701-WN**  
3" C/C | 3 5/8" L



**53702-WN**  
96MM C/C | 4 1/2" L



**53801-WN**  
96MM C/C | 4 1/3" L



**53802-WN**  
128MM C/C | 5 3/4" L



**53803-WN**  
160MM C/C | 7" L



**53804-WN**  
8" C/C | 8 7/8" L



**53805-WN**  
12" C/C | 13" L



**53806-PN**  
18" C/C | 19 1/4" L

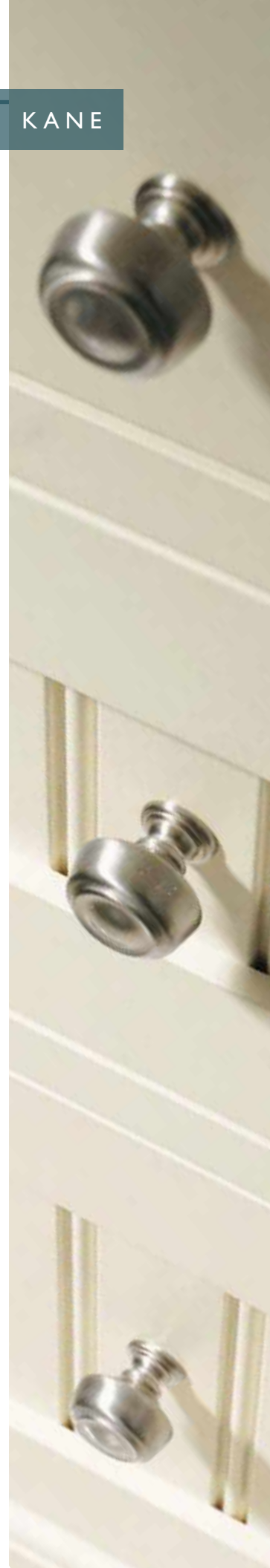

LONDON

AVAILABLE FINISH



**36647-PNBBR**  
1 1/2" L | 1 9/16" PROJ



**36649-PNBBR**  
5 1/16" C/C | 7 1/2" L



**36650-PNBBR**  
6 5/16" C/C | 8 3/4" L



**36651-PNBBR**  
8" C/C | 10 7/16" L



**36664-PNBBR**  
10 1/16" C/C | 12 1/2" L



**36648-PNBBR**  
3 3/4" C/C | 6 5/16" L

MANOR

AVAILABLE FINISHES



**26127-ORB**  
1 1/2" L  
1 1/8" PROJ



**26131-ORB**  
1" L  
1 1/16" PROJ



**26139-2-G10**  
1 7/16" L  
1 1/4" PROJ



**26116-ORB**  
3" C/C | 4 7/16" L



**26130-PN**  
3" C/C | 3 7/16" L



**26117-ORB**  
1 1/16" L  
15/16" PROJ

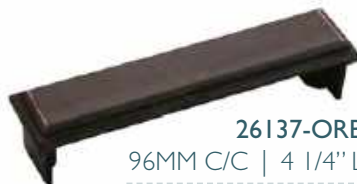

**26137-ORB**  
96MM C/C | 4 1/4" L



**26138-ORB**  
128MM C/C | 5 1/2" L



MERGENCE

AVAILABLE FINISHES



**36858-FBG10**  
96MM C/C | 4 15/16" L



**36859-FBG10**  
128MM C/C | 6 3/16" L



**36860-FBG10**  
160MM C/C | 7 7/16" L



**36861-FBG10**  
224MM C/C | 9 15/16" L



**36857-FBG10**  
1 3/8" DIA | 1" PROJ



AVAILABLE FINISHES



MONUMENT



**36570-ORB**  
96MM C/C | 4 1/8" L



**36571-ORB**  
128MM C/C | 5 7/16" L



**36572-ORB**  
160MM C/C | 6 11/16" L



**36909-ORB**  
224MM C/C | 9 13/16" L



**36568-ORB**  
128MM C/C | 6 7/16" L



**36569-ORB**  
160MM C/C | 7 1/2" L



**36857-FBG10**  
1 3/8" DIA | 1" PROJ



ORB G10 PN  
330-897-0017



Fax Order 330-897-0022



ORB G10 PN

**MULHOLLAND**



**53029-BBZ**  
1 1/4" L  
1 1/8" PROJ



BBR ART GM ORB VB R3 GB BBZ G10 PN



**535342-BBZ**  
1 1/2" L  
1 1/8" PROJ



BBR GM ORB VB GB BBZ G10 PN



**53030-BBZ**  
3" C/C | 3 3/4" L



BBR ART GM ORB GB BBZ G10 PN



**53031-BBZ**  
96MM C/C | 4 9/16" L



BBR GM ORB R3 GB BBZ G10 PN



**53529-BBZ**  
128MM C/C | 5 7/8" L



BBR ART GM ORB VB R3 GB BBZ G10 PN



**53530-BBZ**  
160MM C/C | 7 1/6" L

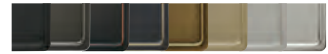

BBR GM ORB VB GB BBZ G10 PN



**53531-BBZ**  
8" C/C | 9 1/6" L



BBR ORB GB BBZ G10 PN



**53532-BBZ**  
12" C/C | 13 1/4" L



BBR ORB GB BBZ G10 PN



**53533-BBZ**  
18" C/C | 19 1/4" L



BBR ORB GB BBZ G10 PN



**53032-WN**  
1 7/16" L  
1" PROJ



WN G10



**53033-WN**  
3" C/C | 3 5/8" L



WN G10

MULINO

AVAILABLE FINISHES



**36724-SCBN**  
128MM C/C | 6 1/4" L

**36725-SCBN**  
192MM C/C | 8 3/4" L

**36726-SCBN**  
256MM C/C | 11 1/4" L



**36720-SCBN**  
2 3/8" L | 1 9/16" PROJ



NATURAL ELEGANCE



**I337-G9**  
1 7/32" DIA  
1 1/4" PROJ



**I338-G9**  
1 9/16" L  
1" PROJ



**I336-RBZ**  
1 11/32" DIA  
1 1/4" PROJ



**I333-PWT**  
3" C/C | 5 1/8" L



NATURE'S SPLENDOR



**I581-ORB**  
1 1/4" DIA  
1 1/8" PROJ

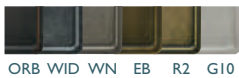

**I583-WN**  
1 7/8" L  
1 1/16" PROJ



**I580-ORB**  
3" C/C | 5 5/8" L

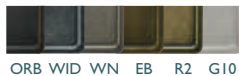

**I582-WN**  
3" C/C | 4 1/4" L



OBERON



**36603-PN**  
1 3/8" DIA  
1 3/16" PROJ



**36604-PN**  
1 3/4" DIA  
1 5/16" PROJ



**36608-PNFA**  
1 3/8" DIA  
1 3/16" PROJ



**36609-PN**  
1 3/4" DIA  
1 5/16" PROJ





PREMISE

AVAILABLE FINISHES



**36843-CZ**

1 1/4" DIA | 1 1/16" PROJ



**36844-CZ**

96MM C/C | 4 1/4" L



**36845-CZ**

128MM C/C | 5 9/16" L



**36846-CZ**

160MM C/C | 6 13/16" L

RADIUS

AVAILABLE FINISHES



**36864-FB**

1 1/4" DIA | 1 1/16" PROJ



**36865-FB**

96MM C/C | 5 3/4" L



**36866-FB**

128MM C/C | 7 1/16" L



**36867-FB**

160MM C/C | 8 5/16" L



**36868-FB**

7 9/16" C/C | 9 9/16" L



**36869-FB**

10 1/16" C/C | 12 1/16" L

AVAILABLE FINISHES

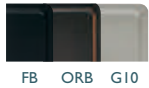

**53012-G10**  
1 1/4" DIA | 1 1/8" PROJ

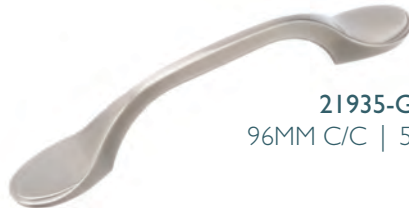

**21935-G10**  
96MM C/C | 5" L



**22094-G10**  
76MM C/C | 3 11/16" L

RAVINO



AVAILABLE FINISHES



**36793-ORB**  
1 1/4" DIA | 1 1/8" PROJ



**36794-ORB**  
96MM C/C | 4 7/16" L



**36795-ORB**  
128MM C/C | 5 11/16" L



**36796-ORB**  
160MM C/C | 7" L

RENOVN



REFLECTIONS



**1387-26**  
1 1/4" DIA  
1 1/16" PROJ



ORB ART AS G10 26



**1384-26**  
3" C/C | 4 1/2" L



26



REVITALIZE



AVAILABLE FINISHES



**55340-ORB**  
1 1/4" L | 7/8" PROJ



**55342-ORB**  
1 1/4" DIA | 1 1/4" PROJ



**55341-ORB**  
1 1/4" DIA  
1 1/8" PROJ



**55343-ORB**  
3" C/C | A3 1 1/16" L



**55344-ORB**  
96MM C/C | 4 5/16" L

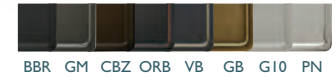

**55346-ORB**  
128MM C/C | 5 5/8" L



**55347-ORB**  
160MM C/C | 6 7/8" L



**55348-ORB**  
8" C/C | 8 7/8" L



**55349-ORB**  
12" C/C | 13" L



**55350-CBZ**  
18" C/C | 18 7/8" L



REVOLVE

AVAILABLE FINISHES

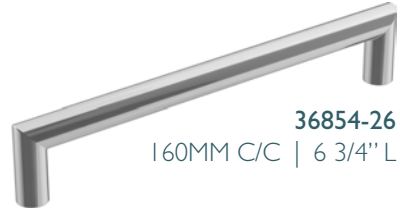
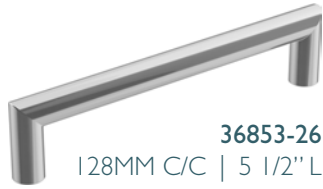

RIFT

AVAILABLE FINISHES



RIVA

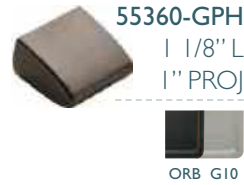

**ROCHDALE**

AVAILABLE FINISHES



**53710-G10**  
1 1/4" DIA  
1 1/8" PROJ



**53715-G10**  
3" C/C | 4 1/2" L



**53716-G10**  
96MM C/C | 5 3/8" L



**53711-G10**  
3" C/C | 4" L



**53712-G10**  
96MM C/C | 4 3/4" L



**53713-G10**  
128MM C/C | 6" L



**53714-G10**  
160MM C/C | 7 1/4" L



**54021-G10**  
12" C/C | 13 1/4" L



**54022-G10**  
18" C/C | 19 1/8" L

**SEA GRASS**

AVAILABLE FINISHES



**36617-BBZ**  
1 3/4" L | 1 5/16" PROJ



**36614-BBZ**  
1 1/2" L | 1 3/16" PROJ



**36615-BBZ**  
3" C/C | 3 7/8" L



**36621-BBZ**  
3 3/4" C/C | 5" L



**36622-BBZ**  
5 1/16" C/C | 6 1/4" L



**36623-BBZ**  
6 5/16" C/C | 7 1/2" L



SEPARA

AVAILABLE FINISHES

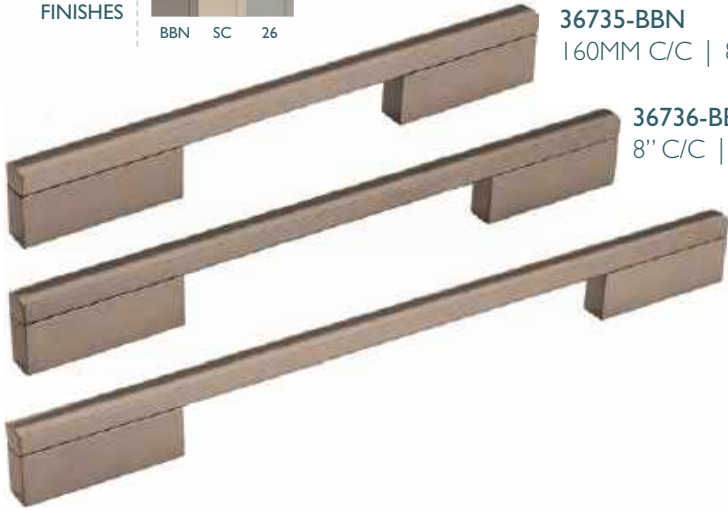

**36735-BBN**  
160MM C/C | 8 13/16" L

**36736-BBN**  
8" C/C | 10 1/2" L

**36737-BBN**  
10 1/16" C/C | 12 5/8" L

AVAILABLE FINISH



**4235-WID**  
76MM C/C | 3 1/2" L

SOLID BRASS CUP PULLS



AVAILABLE FINISHES

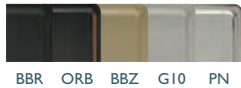

**36643-PN**  
3 3/4" C/C | 6 5/16" L

**36644-PN**  
5 1/16" C/C | 7 1/2" L

**36645-PN**  
6 5/16" C/C | 8 3/4" L



**36642-PN**  
2 1/2" L | 1 7/16" PROJ

ST. VINCENT



STATURE

AVAILABLE FINISHES



**11288-26**  
96MM C/C | 4 9/16" L

**11289-26**  
128MM C/C | 5 13/16" L

**11290-26**  
160MM C/C | 7 1/16" L

**11291-26**  
224MM C/C | 9 9/16" L



**11287-26**  
1 1/4" L | 1 1/4" PROJ



**22439-26**  
128MM C/C | 6 3/8" L

STATUS

AVAILABLE FINISHES



**36837-MB**  
96MM C/C | 4 9/16" L

**36838-MB**  
128MM C/C | 5 13/16" L

**36839-MB**  
160MM C/C | 7 1/16" L

**36840-MB**  
224MM C/C | 9 5/8" L



**36836-MB**  
2" L | 1 1/16" PROJ

**STERLING TRADITIONS**



**1307-ORB**  
1 1/4" DIA  
15/16" PROJ



ORB



**1300-ORB**  
3" C/C | 5 1/4" L



ORB G9



**1302-ORB**  
3" C/C | 5" L



ORB G10 G9



**1313-ORB**  
128MM C/C | 7" L



ORB G10



**1314-ORB**  
160MM C/C | 8 1/4" L



ORB G10

AVAILABLE FINISHES



MB CZ G10 26



**36894-CZ**  
96MM C/C | 4 9/16" L



**36895-CZ**  
128MM C/C | 5 13/16" L



**36896-CZ**  
160MM C/C | 7 1/16" L



**36893-CZ**  
1 1/4" L | 1 3/16" PROJ

**SURPASS**



**9337-ORB**  
3" C/C | 4 1/16" L



ORB G10



**9338-ORB**  
1 1/8" DIA  
1 1/2" PROJ



ORB WID G10

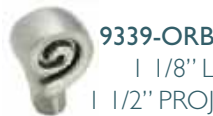

**9339-ORB**  
1 1/8" L  
1 1/2" PROJ



ORB

**SWIRL'Z**



**THE ANNIVERSARY COLLECTION**



**853-G9**  
1 3/16" DIA  
1 1/16" PROJ



BN G9 26



**854-G9**  
3" C/C | 4 1/4" L



ORB G9



**874-G9**  
3" C/C | 5" L



BN PWT G9





TRADITIONAL CLASSICS



**55268-CBBZ**  
1 1/4" DIA  
1 1/2" PROJ



**55266-AORB**  
1" DIA  
1 1/2" PROJ



**14303-3G10**  
1 1/4" DIA  
1 1/4" PROJ



UPRISE



AVAILABLE FINISHES



**36917-G10**  
96MM C/C | 6 5/8" L



**36918-G10**  
128MM C/C | 7 7/8" L



**36919-G10**  
160MM C/C | 10 5/8" L



**36920-G10**  
224MM C/C | 11 15/16" L

VAILE



AVAILABLE FINISHES

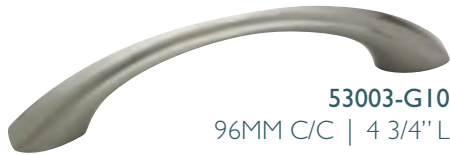

**53003-G10**  
96MM C/C | 4 3/4" L



**53014-G10**  
1 3/8" L | 1 1/2" PROJ

VASARI



24010-SN  
30MM DIA  
1 3/16" PROJ



24003-AN  
30MM DIA  
1 1/8" PROJ



24012-SN  
96MM C/C | 4 1/4" L



24004-WNC  
96MM C/C | 4 1/8" L



24005-WNC  
128MM C/C | 5 3/8" L



24011-WNC  
96MM C/C | 4 1/8" L



24021-AN  
33MM DIA  
1 5/16" PROJ



24020-AN  
96MM C/C | 4 5/8" L



AVAILABLE FINISHES



36912-FB  
96MM C/C | 4 11/16" L

36913-FB  
128MM C/C | 5 15/16" L

36914-FB  
160MM C/C | 7 3/16" L

36912-FB  
224MM C/C | 9 3/4" L



36904-FB  
1 3/8" DIA | 1" PROJ

VERSA

VILLAGE CLASSICS



19321-ORB  
66MM L  
1 1/2" PROJ



19322-FB  
3" C/C | 3 5/8" L



19323-ORB  
96MM C/C | 4 5/8" L

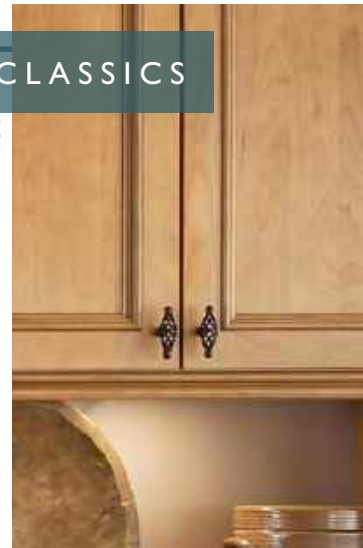

VILLE

AVAILABLE FINISHES



**36774-26**

1 1/8" DIA | 1 1/16" PROJ



**36775-26**

96MM C/C | 4 5/8" L



**36776-26**

128MM C/C | 5 7/8" L



**36777-26**

160MM C/C | 7 1/8" L

WELLS

AVAILABLE FINISHES



**36546-GM**

1 1/4" L | 1 3/16" PROJ



**36547-PN**

1 1/2" L | 1 3/8" PROJ



**36548-GM**

3 3/4" C/C | 4 13/16" L



**36549-GM**

5 1/16" C/C | 6 3/16" L



**36550-GM**

6 5/16" C/C | 7 5/8" L

WESTERLY

AVAILABLE FINISHES



BBR GPH ORB BBZ G10 PN

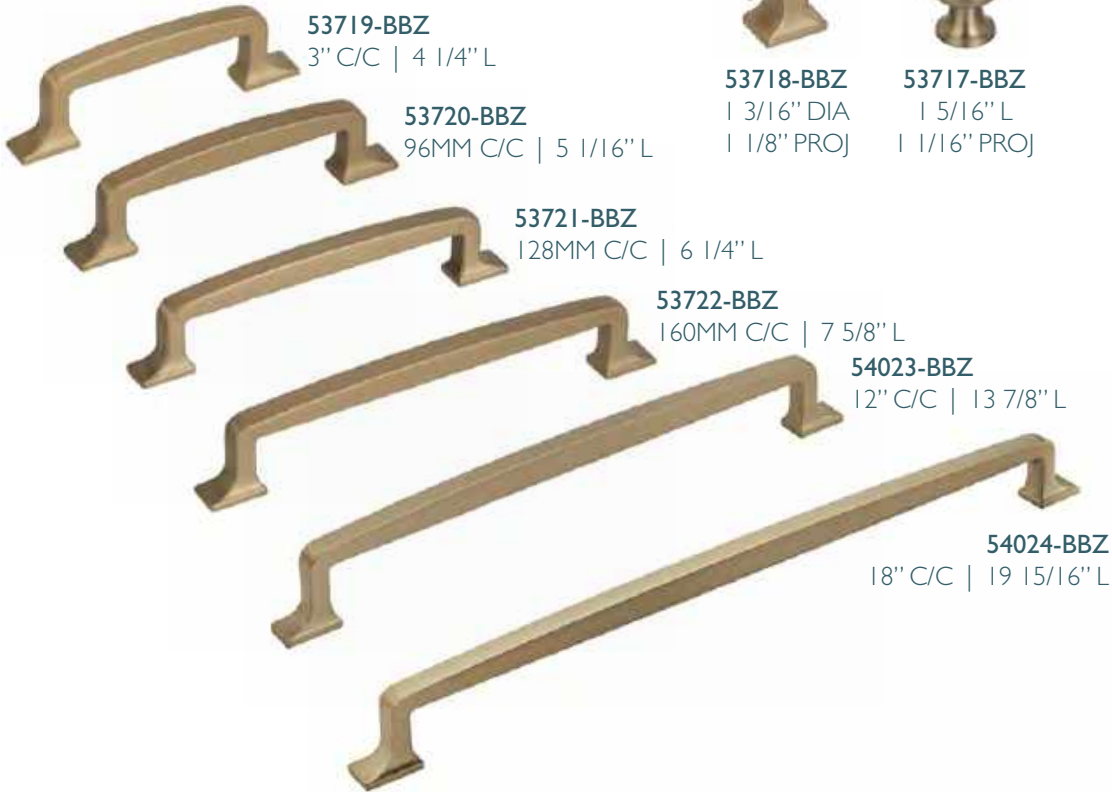

**53719-BBZ**  
3" C/C | 4 1/4" L

**53720-BBZ**  
96MM C/C | 5 1/16" L

**53721-BBZ**  
128MM C/C | 6 1/4" L

**53722-BBZ**  
160MM C/C | 7 5/8" L

**54023-BBZ**  
12" C/C | 13 7/8" L

**54024-BBZ**  
18" C/C | 19 15/16" L

**53718-BBZ**  
1 3/16" DIA  
1 1/8" PROJ

**53717-BBZ**  
1 5/16" L  
1 1/16" PROJ



AVAILABLE FINISHES



FB ORB CZ G10 26

WINSOME

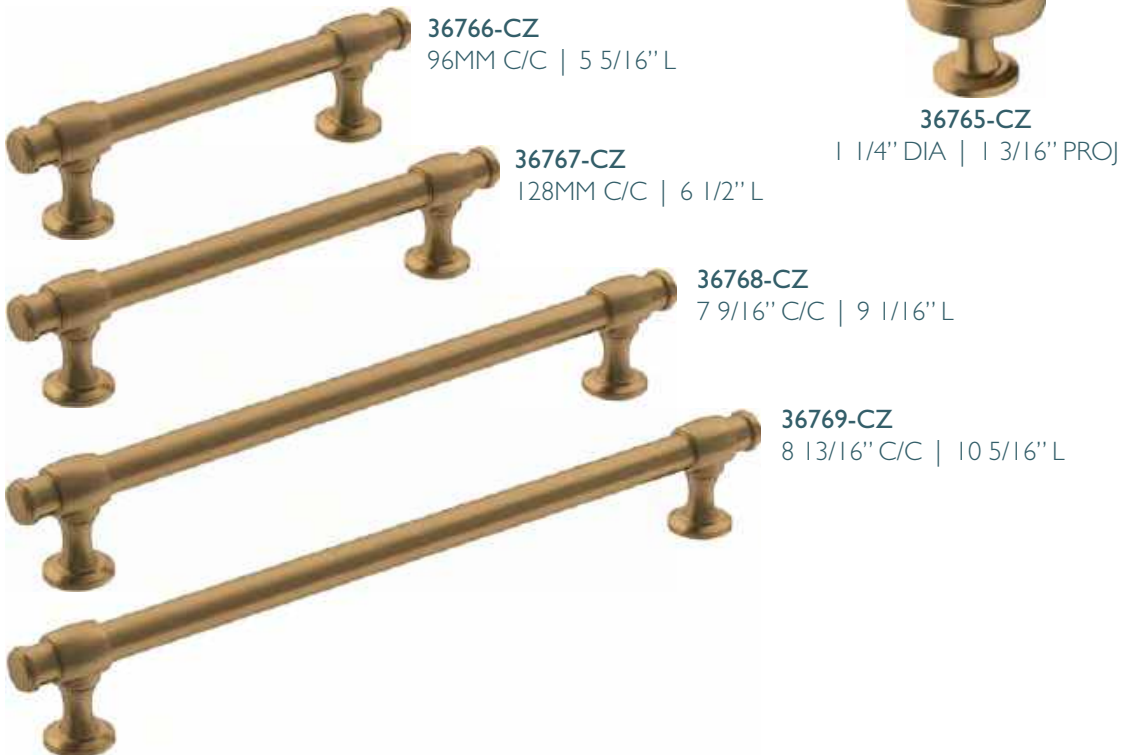

**36766-CZ**  
96MM C/C | 5 5/16" L

**36767-CZ**  
128MM C/C | 6 1/2" L

**36768-CZ**  
7 9/16" C/C | 9 1/16" L

**36769-CZ**  
8 13/16" C/C | 10 5/16" L



**36765-CZ**  
1 1/4" DIA | 1 3/16" PROJ



**ARRONDI**

AVAILABLE FINISHES



**26542-BBZ**  
2 1/16" L  
2 1/16" PROJ

**26540-BBZ**  
7 5/16" L | 3 1/16" PROJ

**26541-BBZ**  
6 3/8" L  
2 1/16" PROJ

**26546-BBZ**  
9" C/C | 11 5/8" L

**26543-BBZ**  
18" C/C | 21" L

**26544-BBZ**  
24" C/C | 26 8/9" L

**26545-BBZ**  
24" C/C | 26 8/9" L

**CLARENDON**

AVAILABLE FINISHES



**26502-G10**  
1 3/4" L | 3" PROJ

**26507-G10**  
8 5/16" L | 3 1/16" PROJ

**26501-G10**  
6 3/16" L | 3" PROJ

**26503-G10**  
18" C/C | 19 3/4" L

**26504-G10**  
24" C/C | 25 3/4" L

**MARKHAM**

AVAILABLE FINISHES



**26512-PN**  
3 5/16" L  
2 3/16" PROJ

**26517-PN**  
9 5/16" L | 3 1/4" PROJ

**26511-PN**  
6 13/16" L  
3 1/8" PROJ

**26513-PN**  
18" C/C | 20 3/8" L

**26514-PN**  
24" C/C | 26 3/8" L

## BACKPLATES



19208-AS  
3" C/C | 5 5/8" L



1971-G10  
96MM C/C | 4 5/8" L



76247-26  
3" C/C | 5 3/4" L



## NON SELF CLOSING "H" HINGE



3404-CB  
FLUSH | 3 1/2" L



3406-CB  
3/8" OFFSET



## MAGNETIC CATCHES

AVAILABLE FINISHES



9765-PT  
5-11 LBS PULL FORCE | 1 15/16" L



9765F-PT  
5-11 LBS PULL FORCE | 1 15/16" L



9773-PT  
5-11 LBS PULL FORCE | 2" L



## HINGES

AVAILABLE FINISHES



7139-14  
2 3/4" L  
VARIABLE OVERLAY

## HINGES

AVAILABLE FINISHES



3429-26  
2 3/4" L  
VARIABLE OVERLAY

**HINGES**

AVAILABLE FINISHES



**3428-3**  
2 3/4" L  
3/8" INSET

**HINGES**

AVAILABLE FINISHES



**7128-BB**  
2 3/4" L  
3/8" INSET

**HINGES**

AVAILABLE FINISHES



**7550-WI**  
2 1/4" L  
1/2" OVERLAY

**HINGES**

AVAILABLE FINISHES



**7566-ORB**  
2 1/4" L  
1/4" OVERLAY

**HINGES**

AVAILABLE FINISHES



**7565-G10**  
2 1/4" L  
3/8" INSET

**HINGES**

AVAILABLE FINISHES



**3175-TB-DAE**  
2 1/2" L

**HINGES**

AVAILABLE FINISHES



**3180-TB-G9**  
2 1/2" L

**HINGES**

AVAILABLE FINISHES



**3175-TM-AE**  
2 7/8" L

**HINGES**

AVAILABLE FINISHES



**3180-TM-14**  
2 3/4" L



*Carrione - page 15*



*Caliber - page 13*

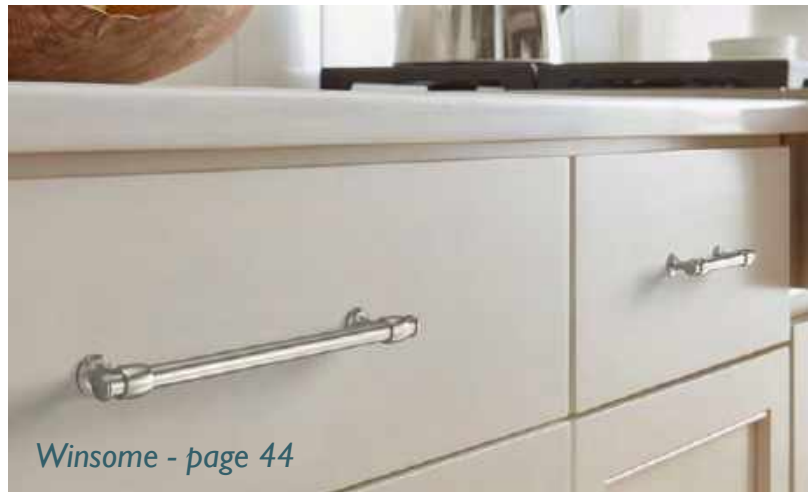

*Winsome - page 44*



*Cyprus & Glacio - pages 17 & 24*



*H-Select*

## STOCKPORT - NEW!



**K3219-96-ORB**  
OIL RUBBED BRONZE  
4 5/8" L  
96MM C/C



**K3219-96-BYAB**  
BLACK YELLOW ANTIQUE BRASS  
4 5/8" L  
96MM C/C



**K3219-96-BRN**  
BRUSHED NICKEL  
4 5/8" L  
96MM C/C



**K3219-ORB**  
OIL RUBBED BRONZE  
1 1/16" DIA  
1" PROJ



**K3219-BYAB**  
BLACK YELLOW ANTIQUE BRASS  
1 1/16" DIA  
1" PROJ



**K3219-BRN**  
BRUSHED NICKEL  
1 1/16" DIA  
1" PROJ

ITEM	1+	25+	100+
<b>K3219-ORB</b>	\$2.75	\$2.35	\$1.95
<b>K3219-BYAB</b>	\$2.75	\$2.35	\$1.95
<b>K3219-BRN</b>	\$2.75	\$2.35	\$1.95
<b>K3219-96-ORB</b>	\$4.50	\$3.95	\$3.50
<b>K3219-96-BYAB</b>	\$4.50	\$3.95	\$3.50
<b>K3219-96-BRN</b>	\$4.50	\$3.95	\$3.50

H-SELECT

## ROWVILLE - NEW!



**K3235-96-BYAB**  
BLACK YELLOW ANTIQUE BRASS  
5 1/8" L  
96MM C/C



**K3235-128-BYAB**  
BLACK YELLOW ANTIQUE BRASS  
6 3/8" L  
128MM C/C



**K3235-96-ORB**  
OIL RUBBED BRONZE  
5 1/8" L  
96MM C/C



**K3235-128-ORB**  
OIL RUBBED BRONZE  
6 3/8" L  
128MM C/C



**K3235-96-BRN**  
BRUSHED NICKEL  
5 1/8" L  
96MM C/C



**K3235-128-BRN**  
BRUSHED NICKEL  
6 3/8" L  
128MM C/C



**K3235-96-BL**  
BLACK  
5 1/8" L  
96MM C/C



**K3235-128-BL**  
BLACK  
6 3/8" L  
128MM C/C

ITEM	1+	25+	100+
<b>K3235-96-BYAB</b>	\$4.25	\$3.75	\$3.25
<b>K3235-128-BYAB</b>	\$4.50	\$3.95	\$3.50
<b>K3235-96-ORB</b>	\$4.25	\$3.75	\$3.25
<b>K3235-128-ORB</b>	\$4.50	\$3.95	\$3.50
<b>K3235-96-BRN</b>	\$4.25	\$3.75	\$3.25
<b>K3235-128-BRN</b>	\$4.50	\$3.95	\$3.50
<b>K3235-96-BL</b>	\$4.25	\$3.75	\$3.25
<b>K3235-128-BL</b>	\$4.50	\$3.95	\$3.50

# H-Select

## CHEYENNE - NEW!



**K3417-ORB**  
OIL RUBBED BRONZE  
1 1/4" DIA  
1" PROJ



**K3417-BB**  
BURNISHED BRASS  
1 1/4" DIA  
1" PROJ



**K3417-WN**  
WEATHERED NICKEL  
1 1/4" DIA  
1" PROJ



**K3417-GOLD**  
GOLD  
1 1/4" DIA  
1" PROJ

ITEM	1+	25+	100+
<b>K3417-ORB</b>	\$2.25	\$1.88	\$1.65
<b>K3417-BB</b>	\$2.25	\$1.88	\$1.65
<b>K3417-WN</b>	\$2.25	\$1.88	\$1.65
<b>K3417-GOLD</b>	\$2.25	\$1.88	\$1.65

## DENALI - NEW!



**K4618-BN**  
BRUSHED NICKEL  
1" DIA  
1 3/16" PROJ



**K4618-SAB**  
SABLE  
1" DIA  
1 3/16" PROJ



**K4618-HB**  
HONEY BRONZED  
1" DIA  
1 3/16" PROJ



**K773-SN**  
SATIN NICKEL  
5 1/4" L  
96MM C/C



**K773-SAB**  
SABLE  
5 1/4" L  
96MM C/C



**K773-HB**  
HONEY BRONZED  
5 1/4" L  
96MM C/C

ITEM	1+	25+	100+
<b>K4618-BN</b>	\$2.95	\$2.55	\$2.25
<b>K4618-SAB</b>	\$2.95	\$2.55	\$2.25
<b>K4618-HB</b>	\$2.95	\$2.55	\$2.25
<b>K773-SN</b>	\$4.25	\$3.75	\$3.25
<b>K773-SAB</b>	\$4.25	\$3.75	\$3.25
<b>K773-HB</b>	\$4.25	\$3.75	\$3.25

H-SELECT

## INSPIRATION RING - NEW!



**K4118-WN**  
WEATHERED NICKEL  
2" DIA  
1 1/2" PROJ



**K4118-BB**  
BURNISHED BRASS  
2" DIA  
1 1/2" PROJ



**K4118-ORB**  
OIL RUBBED BRONZE  
2" DIA  
1 1/2" PROJ

ITEM	1+	25+	100+
<b>K4118-WN</b>	\$1.95	\$1.55	\$1.35
<b>K4118-BB</b>	\$1.95	\$1.55	\$1.35
<b>K4118-ORB</b>	\$1.95	\$1.55	\$1.35

## CLASSIC RING - NEW!



**K4318-BRPW**  
BRUSHED PEWTER  
2" DIA  
1" PROJ



**K4318-BN**  
BRUSHED NICKEL  
2" DIA  
1" PROJ



**K4318-AE**  
ANTIQUENGLISH  
2" DIA  
1" PROJ



**K4318-ORB**  
OIL RUBBED BRONZE  
2" DIA  
1" PROJ

ITEM	1+	25+	100+
<b>K4318-BRPW</b>	\$1.95	\$1.50	\$1.25
<b>K4318-BN</b>	\$1.95	\$1.50	\$1.25
<b>K4318-ORB</b>	\$1.95	\$1.50	\$1.25
<b>K4318-AE</b>	\$1.95	\$1.50	\$1.25

## LINCOLN - NEW!



**K4218-BB**  
BURNISHED BRASS  
7/8" DIA  
3/4" PROJ



**K4218-WN**  
WEATHERED NICKEL  
7/8" DIA  
3/4" PROJ



**K4218-ORB**  
OIL RUBBED BRONZE  
7/8" DIA  
3/4" PROJ

ITEM	1+	25+	100+
<b>K4218-BB</b>	\$1.95	\$1.65	\$1.45
<b>K4218-WN</b>	\$1.95	\$1.65	\$1.45
<b>K4218-ORB</b>	\$1.95	\$1.65	\$1.45

## MISC. KNOBS - NEW!



**K2302-AS**  
ANTIQUENICKEL  
1 1/2" DIA  
1 1/8" PROJ



**K4418-BN**  
BRUSHED NICKEL  
3/4" DIA  
15/16" PROJ



**K3217-DACM**  
DARK ANTIQUE  
COPPER MACHINED  
1 1/4" DIA  
1 1/8" PROJ



**K4438-WI**  
WROUGHT IRON  
1 1/2" DIA  
1 1/4" PROJ

ITEM	1+	25+	100+
<b>K2302-AS</b>	\$1.40	\$1.10	\$0.90
<b>K4418-BN</b>	\$1.45	\$1.20	\$0.99
<b>K3217-DACM</b>	\$2.05	\$1.65	\$1.45
<b>K4438-WI</b>	\$2.65	\$2.15	\$1.85

## BOW



**K2040-BL**  
BLACK  
1 1/4" DIA  
1 1/4" PROJ



**K2040-OB**  
OIL BRONZE  
1 1/4" DIA  
1 1/4" PROJ



**K2040-SN**  
SATIN NICKEL  
1 1/4" DIA  
1 1/4" PROJ



**K2335-OB**  
OIL BRONZE  
1 1/4" DIA  
1" PROJ



**K2335-WN**  
WEATHERED NICKEL  
1" DIA  
3/4" PROJ

ITEM	1+	25+	100+	200+
<b>K2029-ABMD</b>	\$2.95	\$2.55	\$2.15	\$1.75
<b>K2029-BL</b>	\$2.95	\$2.55	\$2.15	\$1.75
<b>K2029-LAP</b>	\$2.95	\$2.55	\$2.15	\$1.75
<b>K2029-OB</b>	\$2.95	\$2.55	\$2.15	\$1.75
<b>K2029-SN</b>	\$2.95	\$2.55	\$2.15	\$1.75
<b>K2040-BL</b>	\$1.85	\$1.65	\$1.35	\$1.10
<b>K2040-OB</b>	\$1.85	\$1.65	\$1.35	\$1.10
<b>K2040-SN</b>	\$1.85	\$1.65	\$1.35	\$1.10
<b>K2335-OB</b>	\$2.25	\$2.00	\$1.50	-
<b>K2335-WN</b>	\$2.25	\$2.00	\$1.50	-



**K2029-BL**  
BLACK  
6 1/8" L  
128MM C/C



**K2029-LAP**  
LIGHT ANTIQUE PEWTER  
6 1/8" L  
128MM C/C



**K2029-OB**  
OIL BRONZE  
6 1/8" L  
128MM C/C



**K2029-SN**  
SATIN NICKEL  
6 1/8" L  
128MM C/C



**K2029-ABMD**  
ANTIQUENICKEL MACHINED DULL  
6 1/8" L  
128MM C/C

## AMERICANA



**K88**  
LANCASTER ANTIQUE  
1 1/4" DIA  
3/4" PROJ



**K88-B**  
PEWTER  
1 1/4" DIA  
3/4" PROJ



**K282-AN**  
ANTIQUÉ NICKEL  
2 1/8" DIA  
7/8" PROJ



**K330-AN**  
ANTIQUÉ NICKEL  
7/8" DIA  
1 1/8" PROJ



**K87**  
LANCASTER ANTIQUE  
4 1/8" L  
3" C/C



**K87-B**  
PEWTER  
4 1/8" L  
3" C/C



**K87-SN**  
SATIN NICKEL  
4 1/8" L  
3" C/C

ITEM	1+	25+	100+
<b>K87</b>	\$2.50	\$1.95	\$1.50
<b>K87-B</b>	\$2.50	\$1.95	\$1.50
<b>K87-SN</b>	\$2.50	\$1.95	\$1.50
<b>K88</b>	\$2.00	\$1.65	\$1.35
<b>K88-B</b>	\$2.00	\$1.65	\$1.35
<b>K282-AN</b>	\$3.25	\$2.85	\$2.45
<b>K330-AN</b>	\$2.00	\$1.75	\$1.50

## BELL IRON 1



**K117-ABMD**  
ANTIQUÉ BRASS  
MACHINED DULL  
1 1/4" DIA  
15/16" PROJ



**K117-DACM**  
DARK BRUSHED  
COPPER MACHINED  
1 1/4" DIA  
15/16" PROJ



**K527-ABMD**  
ANTIQUÉ BRASS MACHINED DULL  
4 1/2" L  
96MM C/C



**K117-DBAC**  
DARK BRUSHED  
ANTIQUÉ COPPER  
1 1/4" DIA  
15/16" PROJ



**K117-SIM**  
PEWTER  
1 1/4" DIA  
15/16" PROJ



**K527-DACM**  
DARK BRUSHED COPPER MACHINED  
4 1/2" L  
96MM C/C



**K527-DBAC**  
DARK BRUSHED ANTIQUÉ COPPER  
4 1/2" L  
96MM C/C



**K527-SIM**  
PEWTER  
4 1/2" L  
96MM C/C

ITEM	1+	25+	100+
<b>K117-ABMD</b>	\$1.85	\$1.67	\$1.55
<b>K117-DACM</b>	\$1.85	\$1.67	\$1.55
<b>K117-DBAC</b>	\$1.85	\$1.67	\$1.55
<b>K117-SIM</b>	\$1.85	\$1.67	\$1.55
<b>K527-ABMD</b>	\$3.60	\$3.15	\$2.50
<b>K527-DACM</b>	\$3.60	\$3.15	\$2.50
<b>K527-DBAC</b>	\$3.60	\$3.15	\$2.50
<b>K527-SIM</b>	\$3.60	\$3.15	\$2.50

## BELL IRON 2



**K6303-RG**  
ROSE GOLD  
1 3/8" DIA  
1" PROJ



**K6303-ABMD**  
ANTIQUÉ BRASS  
MACHINED DULL  
1 3/8" DIA  
1" PROJ



**K6303-DMAC**  
DARK MACHINED  
ANTIQUÉ COPPER  
1 3/8" DIA  
1" PROJ



**K6373-ABMD**  
ANTIQUÉ BRASS MACHINED DULL  
4 1/2" L • 96MM C/C



**K6303-MB**  
MATTE BLACK  
1 3/8" DIA  
1" PROJ



**K6303-DACM**  
DARK BRUSHED  
COPPER MACHINED  
1 3/8" DIA • 1" PROJ



**K6303-SIM**  
PEWTER  
1 3/8" DIA  
1" PROJ



**K6373-DMAC**  
DARK MACHINED ANTIQUÉ COPPER  
4 1/2" L • 96MM C/C



**K6373-DACM**  
DARK BRUSHED COPPER MACHINED  
4 1/2" L • 96MM C/C



**K6373-RG**  
ROSE GOLD  
4 1/2" L • 96MM C/C



**K6373-MB**  
MATTE BLACK  
4 1/2" L • 96MM C/C



**K6373-SIM**  
PEWTER  
4 1/2" L • 96MM C/C

ITEM	1+	25+	100+
<b>K6303-ABMD</b>	\$2.47	\$2.22	\$1.65
<b>K6303-DACM</b>	\$2.47	\$2.22	\$1.65
<b>K6303-DMAC</b>	\$2.47	\$2.22	\$1.65
<b>K6303-SIM</b>	\$2.47	\$2.22	\$1.65
<b>K6303-RG</b>	\$2.47	\$2.22	\$1.65
<b>K6303-MB</b>	\$2.47	\$2.22	\$1.65
<b>K6373-ABMD</b>	\$3.11	\$2.79	\$2.40
<b>K6373-DACM</b>	\$3.11	\$2.79	\$2.40
<b>K6373-DMAC</b>	\$3.11	\$2.79	\$2.40
<b>K6373-SIM</b>	\$3.11	\$2.79	\$2.40
<b>K6373-DBAC</b>	\$3.11	\$2.79	\$2.40
<b>K6373-SN</b>	\$3.11	\$2.79	\$2.40
<b>K6373-RG</b>	\$3.11	\$2.79	\$2.40
<b>K6373-MB</b>	\$3.11	\$2.79	\$2.40

# H-Select

## ADVANTAGE



**K107-AEM**  
ANTIQUE ENGLISH  
1 1/4" DIA  
1" PROJ



**K107-ASM**  
ANTIQUE SILVER  
MACHINED  
1 1/4" DIA  
1" PROJ



**K107-DBAC**  
DARK BRUSHED  
ANTIQUÉ COPPER  
1 1/4" DIA  
1" PROJ



**K107-SN**  
SATIN NICKEL  
1 1/4" DIA  
1" PROJ



**K3898-DBAC**  
DARK BRUSHED  
ANTIQUÉ COPPER  
1 1/8" DIA  
1 1/4" PROJ



**K3898-DBN**  
BRIGHT NICKEL  
BRUSHED DULL  
1 1/8" DIA  
1 1/4" PROJ



**K3208-DBAC**  
DARK BRUSHED  
ANTIQUÉ COPPER  
4 1/4" L  
3" C/C



**K3208-SN**  
SATIN NICKEL  
4 1/4" L  
3" C/C



**K3108-DBAC**  
DARK BRUSHED  
ANTIQUÉ COPPER  
5 1/4" L  
3" C/C



**K516-ASM**  
ANTIQUÉ SILVER  
MACHINED  
5 1/2" L  
3" C/C



**K3108-SN**  
SATIN NICKEL  
5 1/4" L  
3" C/C



**K516-SN**  
SATIN NICKEL  
5 1/2" L  
3" C/C



**K516-AEM**  
ANTIQUÉ ENGLISH  
5 1/2" L  
3" C/C



**K516-DBAC**  
DARK BRUSHED  
ANTIQUÉ COPPER  
5 1/2" L  
3" C/C



**K3899-DBN**  
BRIGHT NICKEL  
BRUSHED DULL  
5 1/4" L  
3" C/C



**K3899-DBAC**  
DARK BRUSHED  
ANTIQUÉ COPPER  
5 1/4" L  
3" C/C

ITEM	1+	25+	100+
K107-AEM	\$1.76	\$1.59	\$1.47
K107-ASM	\$1.76	\$1.59	\$1.47
K107-DBAC	\$1.76	\$1.59	\$1.47
K107-SN	\$1.76	\$1.59	\$1.47
K516-AEM	\$1.76	\$1.59	\$1.47
K516-ASM	\$1.76	\$1.59	\$1.47
K516-DBAC	\$1.76	\$1.59	\$1.47
K516-SN	\$1.76	\$1.59	\$1.47
K3108-DBAC	\$2.50	\$2.00	\$1.50
K3108-SN	\$2.50	\$2.00	\$1.50
K3208-DBAC	\$2.50	\$2.00	\$1.50
K3208-SN	\$2.50	\$2.00	\$1.50
K3898-DBAC	\$1.62	\$1.46	\$1.25
K3898-DBN	\$1.62	\$1.46	\$1.25
K3899-DBAC	\$1.30	\$1.17	\$1.08
K3899-DBN	\$1.30	\$1.17	\$1.08

H-SELECT

## BOUNTIFUL



**K6102-ORB**  
OIL-RUBBED BRONZE  
1 1/4" DIA  
1 1/8" PROJ



**K6102-SN**  
SATIN NICKEL  
1 1/4" DIA  
1 1/8" PROJ



**K6765-ORB**  
OIL-RUBBED BRONZE  
5" L  
3" C/C



**K6765-SN**  
SATIN NICKEL  
5" L  
3" C/C

ITEM	1+	25+	100+
K6102-ORB	\$2.75	\$2.30	\$1.75
K6102-SN	\$2.75	\$2.30	\$1.75
K6765-ORB	\$2.95	\$2.50	\$1.95
K6765-SN	\$2.95	\$2.50	\$1.95

# H-Select

## BASKET WEAVE



**K3062-ORB**  
OIL-RUBBED BRONZE  
1 1/4" DIA  
1" PROJ



**K3062-SN**  
SATIN NICKEL  
1 1/4" DIA  
1" PROJ



**K3062-SI**  
PEWTER  
1 1/4" DIA  
1" PROJ

ITEM	1+	25+	100+
<b>K3062-ORB</b>	\$2.50	\$1.90	\$1.40
<b>K3062-SI</b>	\$2.50	\$1.90	\$1.40
<b>K3062-SN</b>	\$2.50	\$1.90	\$1.40
<b>K3063-ORB</b>	\$2.95	\$2.40	\$1.60
<b>K3063-SI</b>	\$2.95	\$2.40	\$1.60
<b>K3063-SN</b>	\$2.95	\$2.40	\$1.60



**K3063-ORB**  
OIL-RUBBED BRONZE  
4 3/4" L  
3" C/C



**K3063-SN**  
SATIN NICKEL  
4 3/4" L  
3" C/C



**K3063-SI**  
PEWTER  
4 3/4" L  
3" C/C

## COUNTRY TIME



**K6060-DBAC**  
DARK BRUSHED  
ANTIQUÉ COPPER  
1 1/4" DIA  
1 3/8" PROJ



**K6060-DBN**  
BRIGHT NICKEL  
BRUSHED DULL  
1 1/4" DIA  
1 3/8" PROJ



**Z117-DACM**  
DARK BRUSHED  
COPPER MACHINED  
1 1/4" DIA  
1" PROJ



**Z117-DBN**  
BRIGHT NICKEL  
BRUSHED DULL  
1 1/4" DIA  
1" PROJ



**Z117-SIM**  
PEWTER  
1 1/4" DIA  
1" PROJ

ITEM	1+	25+	100+	200+
<b>K260-DBAC</b>	\$2.25	\$1.75	\$1.50	\$1.45
<b>K260-DBN</b>	\$2.25	\$1.75	\$1.50	\$1.45
<b>K6060-DBAC</b>	\$2.25	\$1.75	\$1.50	\$1.45
<b>K6060-DBN</b>	\$2.25	\$1.75	\$1.50	\$1.45
<b>Z117-DACM</b>	\$2.25	\$1.75	\$1.50	\$1.45
<b>Z117-DBN</b>	\$2.25	\$1.75	\$1.50	\$1.45
<b>Z117-SIM</b>	\$2.25	\$1.75	\$1.50	\$1.45



**K260-DBAC**  
DARK BRUSHED ANTIQUÉ COPPER  
3 3/4" L  
3" C/C



**K260-DBN**  
BRIGHT NICKEL BRUSHED DULL  
3 3/4" L  
3" C/C

## HARVEST



**K6464-DBAC**  
DARK BRUSHED  
ANTIQUÉ COPPER  
1 1/4" DIA  
1 1/8" PROJ



**K6464-SN**  
SATIN NICKEL  
1 1/4" DIA  
1 1/8" PROJ

ITEM	1+	25+	100+
<b>K6464-DBAC</b>	\$2.50	\$1.90	\$1.40
<b>K6464-SN</b>	\$2.50	\$1.90	\$1.40
<b>K6465-DBAC</b>	\$2.89	\$2.40	\$1.60
<b>K6465-SN</b>	\$2.89	\$2.40	\$1.60



**K6465-DBAC**  
DARK BRUSHED ANTIQUÉ  
COPPER  
5 5/8" L  
3" C/C



**K6465-SN**  
SATIN NICKEL  
5 5/8" L  
3" C/C

## FLAIR



**K196-ACM**  
ANTIQUE COPPER MACHINED  
2 1/4" L  
1 1/4" C/C



**K196-DBAC**  
DARK BRUSHED ANTIQUE COPPER  
2 1/4" L  
1 1/4" C/C



**K195-ACM**  
ANTIQUE COPPER MACHINED  
4 7/8" L  
96MM C/C



**K195-DBAC**  
DARK BRUSHED ANTIQUE COPPER  
4 7/8" L  
96MM C/C

ITEM	1+	25+	100+
<b>K195-ACM</b>	\$3.00	\$2.85	\$2.50
<b>K195-DBAC</b>	\$3.00	\$2.85	\$2.50
<b>K196-ACM</b>	\$2.00	\$1.85	\$1.50
<b>K196-DBAC</b>	\$2.00	\$1.85	\$1.50

H-SELECT

## DELGADO



**K519-ABSB**  
ANTIQUE BRUSHED SATIN BRASS  
1 1/2" L  
1 1/4" PROJ



**K519-DBAC**  
DARK BRUSHED ANTIQUE COPPER  
1 1/2" L  
1 1/4" PROJ



**K519-DBN**  
BRIGHT NICKEL BRUSHED DULL  
1 1/2" L  
1 1/4" PROJ

ITEM	1+	25+	100+
<b>K519-96ABSB</b>	\$5.50	\$4.95	\$4.50
<b>K519-96DBAC</b>	\$5.50	\$4.95	\$4.50
<b>K519-96DBN</b>	\$5.50	\$4.95	\$4.50
<b>K519-ABSB</b>	\$3.25	\$2.95	\$2.50
<b>K519-DBAC</b>	\$3.25	\$2.95	\$2.50
<b>K519-DBN</b>	\$3.25	\$2.95	\$2.50



**K519-96ABSB**  
ANTIQUE BRUSHED SATIN BRASS  
4 1/4" L  
96MM C/C



**K519-96DBAC**  
DARK BRUSHED ANTIQUE COPPER  
4 1/4" L  
96MM C/C



**K519-96DBN**  
BRIGHT NICKEL BRUSHED DULL  
4 1/4" L  
96MM C/C

## ROCHESTER



**K155-ABSB**  
ANTIQUE BRUSHED SATIN BRASS  
1 1/8" DIA  
15/16" PROJ



**K155-DBAC**  
DARK BRUSHED ANTIQUE COPPER  
1 1/8" DIA  
15/16" PROJ



**K155-DBN**  
BRIGHT NICKEL BRUSHED DULL  
1 1/8" DIA  
15/16" PROJ



**K155-SN**  
SATIN NICKEL  
1 1/8" DIA  
15/16" PROJ

ITEM	1+	25+	100+
<b>K155-96ABSB</b>	\$3.95	\$3.45	\$2.99
<b>K155-96DBAC</b>	\$3.95	\$3.45	\$2.99
<b>K155-96DBN</b>	\$3.95	\$3.45	\$2.99
<b>K155-96SN</b>	\$3.95	\$3.45	\$2.99
<b>K155-ABSB</b>	\$2.50	\$2.15	\$1.85
<b>K155-DBAC</b>	\$2.50	\$2.15	\$1.85
<b>K155-DBN</b>	\$2.50	\$2.15	\$1.85
<b>K155-SN</b>	\$2.50	\$2.15	\$1.85



**K155-96ABSB**  
ANTIQUE BRUSHED SATIN BRASS  
4 1/4" L  
96MM C/C



**K155-96DBAC**  
DARK BRUSHED ANTIQUE COPPER  
4 1/4" L 96MM C/C



**K155-96DBN**  
BRIGHT NICKEL BRUSHED DULL  
4 1/4" L  
96MM C/C



**K155-96SN**  
SATIN NICKEL  
4 1/4" L 96MM C/C



## BALANCE



**K2980-AB**  
ANTIQUE ENGLISH  
1 1/4" DIA  
1 1/8" PROJ



**K2980-DACM**  
DARK BRUSHED  
COPPER MACHINED  
1 1/4" DIA  
1 1/8" PROJ



**K2980-SN**  
SATIN NICKEL  
1 1/4" DIA  
1 1/8" PROJ



**K2980-DBAC**  
DARK BRUSHED  
ANTIQUE COPPER  
1 1/4" DIA  
1 1/8" PROJ



**K2980-ORB**  
OIL-RUBBED  
BRONZE  
1 1/4" DIA  
1 1/8" PROJ



**K2981-AB**  
ANTIQUE ENGLISH  
3 3/4" L  
3" C/C



**K2981-DACM**  
DARK BRUSHED COPPER MACHINED  
3 3/4" L  
3" C/C



**K2981-DBAC**  
DARK BRUSHED ANTIQUE COPPER  
3 3/4" L  
3" C/C



**K2981-SN**  
SATIN NICKEL  
3 3/4" L  
3" C/C



**K2981-ORB**  
OIL-RUBBED BRONZE  
3 3/4" L  
3" C/C

ITEM	1+	25+	100+
<b>K2980-AB</b>	\$1.95	\$1.75	\$1.51
<b>K2980-DACM</b>	\$1.95	\$1.75	\$1.51
<b>K2980-DBAC</b>	\$1.95	\$1.75	\$1.51
<b>K2980-ORB</b>	\$1.95	\$1.75	\$1.51
<b>K2980-SN</b>	\$1.95	\$1.75	\$1.51
<b>K2981-AB</b>	\$2.45	\$2.25	\$2.00
<b>K2981-DACM</b>	\$2.45	\$2.25	\$2.00
<b>K2981-DBAC</b>	\$2.45	\$2.25	\$2.00
<b>K2981-ORB</b>	\$2.45	\$2.25	\$2.00
<b>K2981-SN</b>	\$2.45	\$2.25	\$2.00

## CLARK

### ZINC DIE CAST



**K801-B**  
PEWTER  
1 1/8" DIA  
1 1/8" PROJ



**K800-SN**  
SATIN NICKEL  
1 1/8" DIA  
1 1/8" PROJ



**K802-AE**  
ANTIQUE ENGLISH  
1 1/8" DIA  
1 1/8" PROJ



**K803-BI**  
BLACK IRON  
1 1/8" DIA  
1 1/8" PROJ



**K810-MB**  
MATTE BLACK  
1 1/8" DIA  
1 1/8" PROJ



**K804-B**  
PEWTER  
3 3/4" L  
3" C/C



**K805-SN**  
SATIN NICKEL  
3 3/4" L  
3" C/C



**K806-AE**  
ANTIQUE ENGLISH  
3 3/4" L  
3" C/C



**K807-BI**  
BLACK IRON  
3 3/4" L  
3" C/C



**K811-MB**  
MATTE BLACK  
3 3/4" L  
3" C/C

ITEM	1+	25+	100+
<b>K800-SN</b>	\$0.84	\$0.73	\$0.67
<b>K801-B</b>	\$1.50	\$1.35	\$1.10
<b>K802-AE</b>	\$1.50	\$1.35	\$1.10
<b>K803-BI</b>	\$1.50	\$1.35	\$1.10
<b>K804-B</b>	\$2.45	\$1.90	\$1.65
<b>K805-SN</b>	\$2.45	\$1.90	\$1.65
<b>K806-AE</b>	\$2.45	\$1.90	\$1.65
<b>K807-BI</b>	\$2.45	\$1.90	\$1.65
<b>K810-MB</b>	\$0.84	\$0.73	\$0.67
<b>K811-MB</b>	\$2.45	\$1.90	\$1.65

## BAR PULLS

H-SELECT



**K1001**  
BRUSHED NICKEL 1 9/16" L  
1 3/8" PROJ



**K1000**  
BRUSHED NICKEL  
4 1/2" L  
76MM C/C



**K1002**  
BRUSHED NICKEL  
5 5/16" L  
96MM C/C



**K1003**  
BRUSHED NICKEL  
6 5/8" L  
128MM C/C



**K1004**  
BRUSHED NICKEL  
7 7/8" L  
160MM C/C



**K1005**  
BRUSHED NICKEL  
9 1/8" L  
192MM C/C



**K1006**  
BRUSHED NICKEL  
10 3/8" L  
224MM C/C



**K1007**  
BRUSHED NICKEL  
11 5/8" L  
256MM C/C



**K1008**  
BRUSHED NICKEL  
12 7/8" L  
288MM C/C



**K1009**  
BRUSHED NICKEL  
14 3/16" L  
320MM C/C



**K1010**  
BRUSHED NICKEL  
15 7/16" L  
352MM C/C

ITEM	1+	25+	100+
K1000	\$2.70	\$2.20	\$1.55
K1001	\$1.00	\$0.90	\$0.80
K1002	\$2.75	\$2.25	\$1.60
K1003	\$3.00	\$2.50	\$1.80
K1004	\$3.20	\$2.70	\$2.05
K1005	\$3.50	\$3.00	\$2.30
K1006	\$3.70	\$3.20	\$2.48
K1007	\$3.90	\$3.50	\$2.73
K1008	\$4.50	\$3.90	\$2.93
K1009	\$4.70	\$4.00	\$3.18
K1010	\$5.00	\$4.25	\$3.40

# H-Select

## SLEEK & MODERN



**K1216-SN**  
SATIN NICKEL  
7/8" DIA  
1" PROJ



**K426-SN**  
SATIN NICKEL  
7/8" DIA  
1" PROJ



**K26-SN**  
SATIN NICKEL  
1" DIA  
15/16" PROJ



**K8026-SN**  
SATIN NICKEL  
1 3/4" L  
3/4" PROJ



**K515-SN**  
SATIN NICKEL  
1 1/8" DIA  
1" PROJ



**D2753-SN**  
SATIN NICKEL  
1 5/16" L  
1 1/8" PROJ



**K790-SN**  
SATIN NICKEL  
1" DIA  
1" PROJ



**Z259-BL**  
BLACK  
3 3/8" L  
3" C/C



**Z259-SN**  
SATIN NICKEL  
3 3/8" L  
3" C/C



**K400-SN**  
SATIN NICKEL  
4" L  
3" C/C



**K475-SN**  
SATIN NICKEL  
4 3/4" L  
96MM C/C



**K3489-SN**  
SATIN NICKEL  
4 1/2" L  
3" C/C



**K3489-MB**  
MATTE BLACK  
4 1/2" L  
3" C/C



**K272-BL**  
BLACK  
4 5/8" L  
96MM C/C



**K4690-SN**  
SATIN NICKEL  
4 3/4" L  
96MM C/C



**K272-SN**  
SATIN NICKEL  
4 5/8" L  
96MM C/C



**K2017-SN**  
SATIN NICKEL  
5" L  
96MM C/C



**K961-DSN**  
SATIN NICKEL  
4 3/4" L  
3" CC



**K2017-BL**  
BLACK  
5" L  
96MM C/C



**K4655-SN**  
SATIN NICKEL  
6 1/4" L  
5" C/C



**K4655-BLK**  
BLACK  
6 1/4" L  
5" C/C



**K4655-AB**  
ANTIQUE ENGLISH  
6 1/4" L  
5" C/C



**K5319-SN**  
SATIN NICKEL  
14 1/8" L  
12 1/2" C/C

ITEM	1+	25+	100+
D2753-SN	\$2.63	\$2.27	\$1.70
K26-SN	\$1.75	\$1.55	\$1.25
K272-BL	\$1.75	\$1.55	\$1.25
K272-SN	\$1.75	\$1.55	\$1.25
K400-SN	\$3.00	\$2.40	\$1.75
K426-SN	\$1.75	\$1.55	\$1.25
K475-SN	\$3.00	\$2.40	\$1.95
K515-SN	\$1.75	\$1.55	\$1.25
K790-SN	\$2.05	\$1.75	\$1.50
K961-DSN	\$3.00	\$2.50	\$2.25
K1216-SN	\$1.75	\$1.50	\$1.25
K2017-BL	\$2.25	\$1.75	\$1.40
K2017-SN	\$2.25	\$1.75	\$1.40
K3489-MB	\$2.75	\$2.25	\$1.95
K3489-SN	\$2.75	\$2.25	\$1.95
K4655-AB	\$2.75	\$2.25	\$1.95
K4655-BLK	\$2.75	\$2.25	\$1.95
K4655-SN	\$2.75	\$2.25	\$1.95
K4690-SN	\$2.75	\$2.25	\$1.50
K5319-SN	\$5.50	\$5.00	\$4.75
K8026-SN	\$1.75	\$1.50	\$1.25
Z259-BL	\$2.00	\$1.75	\$1.25
Z259-SN	\$2.00	\$1.75	\$1.25

H-SELECT

# H-Select

## GLENDALE



**K525-DBAC**  
DARK BRUSHED ANTIQUE  
COPPER  
1 1/16" SQ  
1" PROJ



**K525-DMAC**  
DARK MACHINED ANTIQUE  
COPPER  
1 1/16" SQ  
1" PROJ

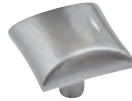

**K525-SN**  
SATIN NICKEL  
1 1/16" SQ  
1" PROJ

ITEM	1+	25+	100+
<b>K525-96DBAC</b>	\$2.10	\$1.90	\$1.60
<b>K525-96DMAC</b>	\$2.10	\$1.90	\$1.60
<b>K525-96SN</b>	\$2.10	\$1.90	\$1.60
<b>K525-DBAC</b>	\$1.65	\$1.50	\$1.29
<b>K525-DMAC</b>	\$1.65	\$1.50	\$1.29
<b>K525-SN</b>	\$1.65	\$1.50	\$1.29



**K525-96DBAC**  
DARK BRUSHED  
ANTIQUÉ COPPER  
5" L  
96MM C/C



**K525-96DMAC**  
DARK MACHINED  
ANTIQUÉ COPPER  
5" L  
96MM C/C



**K525-96SN**  
SATIN NICKEL  
5" L  
96MM C/C

H-SELECT

## KINGSPORT



**K150-LP**  
LANCASTER ANTIQUE  
2 7/8" X 4 1/4"  
3" C/C

ITEM	1+	25+	100+
<b>K150-LP</b>	\$2.35	\$2.10	\$1.90

## WHEAT



**DRAWER BAIL PULL**  
**K200-LP**  
LANCASTER ANTIQUE  
2 5/8" X 4 1/2"  
3" C/C



**KNOB**  
**K204-LP**  
LANCASTER ANTIQUE  
1 1/4" DIA  
1 1/4" PROJ



**BAR HANDLE**  
**K205-LP**  
LANCASTER ANTIQUE  
4 1/4" L  
3" C/C

ITEM	1+	25+	100+
<b>K200-LP</b>	\$2.50	\$1.90	\$1.50
<b>K204-LP</b>	\$2.50	\$1.90	\$1.50
<b>K205-LP</b>	\$2.50	\$1.90	\$1.50

## OLD ENGLISH



**K152-AE**  
ANTIQUÉ ENGLISH  
4 3/4" L  
3" C/C



**K706-AE**  
ANTIQUÉ ENGLISH  
4 7/8" L  
3" C/C

ITEM	1+	25+	100+
<b>K152-AE</b>	\$2.63	\$1.80	\$1.45
<b>K706-AE</b>	\$2.63	\$1.80	\$1.45
<b>K707-AE</b>	\$2.63	\$1.80	\$1.45



**K707-AE**  
ANTIQUÉ ENGLISH  
4 1/4" L  
2 1/2" C/C

# H-Select

## CHIPPENDALE



**K1461-AE**  
SOLID BRASS WITH ANTIQUE  
ENGLISH FINISH  
2 1/4" X 3 3/16"  
2" C/C



**K1461-PB**  
SOLID BRASS WITH POLISHED  
BRASS FINISH  
2 1/4" X 3 3/16"  
2" C/C



**K1462-AE**  
SOLID BRASS WITH ANTIQUE  
ENGLISH FINISH  
2 3/4" X 3 3/4"  
2 1/2" C/C



**K1462-PB**  
SOLID BRASS WITH POLISHED  
BRASS FINISH  
2 3/4" X 3 3/4"  
2 1/2" C/C



**K1463-AE**  
SOLID BRASS WITH ANTIQUE  
ENGLISH FINISH  
3 3/8" X 4 1/2"  
3" C/C



**K1463-PB**  
SOLID BRASS WITH POLISHED  
BRASS FINISH  
3 3/8" X 4 1/2"  
3" C/C

ITEM	1+	25+	100+
<b>K1461-AE</b>	\$5.78	\$5.05	\$4.20
<b>K1461-PB</b>	\$4.41	\$3.81	\$3.10
<b>K1462-AE</b>	\$6.30	\$5.77	\$4.80
<b>K1462-PB</b>	\$4.83	\$4.33	\$3.60
<b>K1463-AE</b>	\$7.46	\$6.90	\$5.70
<b>K1463-PB</b>	\$5.88	\$5.25	\$4.25
<b>K1464-AE</b>	\$3.89	\$2.99	\$2.50
<b>K1464-PB</b>	\$2.94	\$2.77	\$1.90



**K1464-AE**  
SOLID BRASS WITH ANTIQUE  
ENGLISH FINISH  
2 1/4" X 3 1/8"



**K1464-PB**  
SOLID BRASS WITH POLISHED  
BRASS FINISH  
2 1/4" X 3 1/8"

H-SELECT

## NEW IMPORTS ANTIQUE ENGLISH



**80176-AE**  
PULL  
**81177-AE**  
BACKPLATE  
3" C/C  
4 1/4" L



**80223-AE**  
3" C/C  
5 1/4" L



**80859-AE**  
ANTIQUE ENGLISH  
5" L  
3" C/C



**80644-AE**  
3" C/C  
5" L

ITEM	1+	25+	100+
<b>80644-AE</b>	\$2.43	\$2.11	\$1.94
<b>80223-AE</b>	\$1.82	\$1.57	\$1.45
<b>80859-AE</b>	\$2.63	\$1.75	\$1.25
<b>80176-AE</b>	\$2.43	\$2.11	\$1.94
<b>80177-AE</b>	\$1.80	\$1.50	\$1.40

## LAFAYETTE



**K417-ABSB**  
ANTIQUE BRUSHED SATIN BRASS  
1 3/8" DIA  
1 1/4" PROJ



**K417-DBAC**  
DARK BRUSHED ANTIQUE COPPER  
1 3/8" DIA  
1 1/4" PROJ



**K417-DBN**  
BRIGHT NICKEL BRUSHED DULL  
1 3/8" DIA  
1 1/4" PROJ



**K517-ABSB**  
ANTIQUE BRUSHED SATIN BRASS  
1 3/8" DIA  
1 1/4" PROJ



**K517-DBAC**  
DARK BRUSHED ANTIQUE COPPER  
1 3/8" DIA  
1 1/4" PROJ



**K517-DBN**  
BRIGHT NICKEL BRUSHED DULL  
1 3/8" DIA  
1 1/4" PROJ

ITEM	1+	25+	100+
<b>K317-96ABSB</b>	\$4.50	\$3.95	\$3.45
<b>K317-96DBAC</b>	\$4.50	\$3.95	\$3.45
<b>K317-96DBN</b>	\$4.50	\$3.95	\$3.45
<b>K417-ABSB</b>	\$3.70	\$3.30	\$3.05
<b>K417-DBAC</b>	\$3.70	\$3.30	\$3.05
<b>K417-DBN</b>	\$3.70	\$3.30	\$3.05
<b>K517-ABSB</b>	\$2.55	\$2.10	\$1.65
<b>K517-DBAC</b>	\$2.55	\$2.10	\$1.65
<b>K517-DBN</b>	\$2.55	\$2.10	\$1.65



**K317-96ABSB**  
ANTIQUE BRUSHED SATIN BRASS  
4 3/8" L  
96MM C/C



**K317-96DBAC**  
DARK BRUSHED ANTIQUE COPPER  
4 3/8" L  
96MM C/C



**K317-96DBN**  
BRIGHT NICKEL BRUSHED DULL  
4 3/8" L  
96MM C/C

## RICHELIEU



**Knob**  
**K147-AE**  
ANDOVER ANTIQUE  
1 3/8" L  
1 1/8" PROJ



**BACKPLATE**  
**K105-AE**  
ANDOVER ANTIQUE  
1" X 4 1/8"

ITEM	1+	25+	100+
<b>K105-AE</b>	\$2.75	\$2.50	\$2.25
<b>K147-AE</b>	\$2.75	\$2.50	\$2.25

## ANTIQUENGLISH



**A76209-AE**  
ANTIQUENGLISH  
1 1/8" DIA  
1" PROJ



**D89-AE**  
ANTIQUENGLISH  
3/4" DIA  
5/8" PROJ



**D89-BL**  
BLACK  
3/4" DIA  
5/8" PROJ



**K208-AE**  
ANTIQUENGLISH  
1 1/8" DIA  
3/4" PROJ

ITEM	1+	25+	100+
<b>A76209-AE</b>	\$1.50	\$1.25	\$1.10
<b>D89-AE</b>	\$1.50	\$1.30	\$1.00
<b>D89-BL</b>	\$1.50	\$1.30	\$1.00
<b>K156-AE</b>	\$2.65	\$1.95	\$1.50
<b>K157-AE</b>	\$2.65	\$2.05	\$1.75
<b>K208-AE</b>	\$1.55	\$1.30	\$0.95
<b>K3208-AE</b>	\$2.50	\$2.00	\$1.50
<b>K703-AE</b>	\$1.60	\$1.45	\$1.00
<b>K763-AE</b>	\$2.65	\$1.75	\$1.25



**K157-AE**  
ANTIQUENGLISH  
4 3/4" L  
3" C/C



**K703-AE**  
ANTIQUENGLISH  
5 1/2" L



**K763-AE**  
ANTIQUENGLISH  
5 3/8" L  
3" C/C



**K3208-AE**  
ANTIQUENGLISH  
4 1/4" L  
3" C/C



**K156-AE**  
ANTIQUENGLISH  
4 1/2" L  
3" C/C

## STICKLEY MISSION II

ZINC DIE CAST



**D924-AC**  
ANTIQUE COPPER  
3 3/4" X 1"  
3" C/C



**D924-AE**  
ANTIQUE ENGLISH  
3 3/4" X 1"  
3" C/C



**D924-BL**  
BLACK  
3 3/4" X 1"  
3" C/C

ITEM	1+	25+	100+
D924-AC	\$3.50	\$2.95	\$2.65
D924-AE	\$3.50	\$2.95	\$2.65
D924-BL	\$3.50	\$2.95	\$2.65
D925-AC	\$3.50	\$2.95	\$2.65
D925-AE	\$3.50	\$2.95	\$2.65
D925-BL	\$3.50	\$2.95	\$2.65
D942-AC	\$2.85	\$2.40	\$2.10
D942-AE	\$2.85	\$2.40	\$2.10
D942-BL	\$2.85	\$2.40	\$2.10



**D925-AC**  
ANTIQUE COPPER  
1 5/8" X 3 1/2"  
3" C/C



**D925-AE**  
ANTIQUE ENGLISH  
1 5/8" X 3 1/2"  
3" C/C



**D925-BL**  
BLACK  
1 5/8" X 3 1/2"  
3" C/C



**D942-AC**  
ANTIQUE COPPER  
1 1/4" SQ  
7/8" PROJ

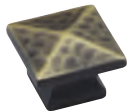

**D942-AE**  
ANTIQUE ENGLISH  
1 1/4" SQ  
7/8" PROJ



**D942-BL**  
BLACK  
1 1/4" SQ  
7/8" PROJ

## PERIOD MISSION



**D552-AC**  
ANTIQUE COPPER  
4 1/2" X 1 1/4"  
3" C/C



**D552-BL**  
BLACK  
4 1/2" X 1 1/4"  
3" C/C



**D552-ORB**  
OIL-RUBBED BRONZE  
4 1/2" X 1 1/4"  
3" C/C

ITEM	1+	25+	100+
D552-AC	\$3.55	\$3.05	\$2.65
D552-BL	\$3.55	\$3.05	\$2.65
D552-ORB	\$3.55	\$3.05	\$2.65
D553-AC	\$3.55	\$3.05	\$2.65
D553-BL	\$3.55	\$3.05	\$2.65
D553-ORB	\$3.55	\$3.05	\$2.65



**D553-AC**  
ANTIQUE COPPER  
1 1/4" X 4 1/2"  
3" C/C



**D553-BL**  
BLACK  
1 1/4" X 4 1/2"  
3" C/C



**D553-ORB**  
OIL-RUBBED BRONZE  
1 1/4" X 4 1/2"  
3" C/C

## TRADITIONAL MISSION

### HEAVY DUTY BAILS



**D527-A**  
BLACK  
3 3/4" X 1"  
2 1/4" C/C



**D527-AE**  
ANTIQUE ENGLISH  
3 3/4" X 1"  
2 1/4" C/C



**D527-B**  
PEWTER  
3 3/4" X 1"  
2 1/4" C/C

ITEM	1+	25+	100+	500+
D527-A	\$2.05	\$1.95	\$1.45	\$1.10
D527-AE	\$2.05	\$1.95	\$1.45	\$1.10
D527-B	\$2.05	\$1.95	\$1.45	\$1.10
D528-A	\$2.63	\$2.50	\$2.00	\$1.50
D528-AE	\$2.63	\$2.50	\$2.00	\$1.50
D528-B	\$2.63	\$2.50	\$2.00	\$1.50
D529-A	\$2.63	\$2.50	\$1.90	\$1.35
D529-AE	\$2.63	\$2.50	\$1.90	\$1.35
D529-B	\$2.63	\$2.50	\$1.90	\$1.35



**D528-A**  
BLACK  
1 3/4" X 2 3/4"  
1 1/8" C/C



**D528-AE**  
ANTIQUE ENGLISH  
1 3/4" X 2 3/4"  
1 1/8" C/C



**D528-B**  
PEWTER  
1 3/4" X 2 3/4"  
1 1/8" C/C



**D529-A**  
BLACK  
2" X 3 3/4"  
3" C/C



**D529-AE**  
ANTIQUE ENGLISH  
2" X 3 3/4"  
3" C/C



**D529-B**  
PEWTER  
2" X 3 3/4"  
3" C/C

## REFINED MISSION



**D523-BL**  
BLACK  
1 1/8" DIA  
1" PROJ



**D523-SN**  
SATIN NICKEL  
1 1/8" DIA  
1" PROJ



**D523-W**  
WROUGHT IRON  
1 1/8" DIA  
1" PROJ



**D521-BL**  
BLACK  
4 1/16" L  
3" C/C



**D521-SN**  
SATIN NICKEL  
4 1/16" L  
3" C/C



**D521-W**  
WROUGHT IRON  
4 1/16" L  
3" C/C

ITEM	1+	25+	100+
D521-BL	\$2.50	\$2.05	\$1.75
D521-SN	\$2.50	\$2.05	\$1.75
D521-W	\$2.50	\$2.05	\$1.75
D523-BL	\$1.85	\$1.65	\$1.45
D523-SN	\$1.85	\$1.65	\$1.45
D523-W	\$1.85	\$1.65	\$1.45
HH4424-BL	\$3.95	\$3.55	\$2.95
HH4425-BL	\$2.65	\$2.25	\$1.95



**HH4424-BL**  
BLACK  
4" L  
3" C/C



**HH4425-BL**  
BLACK  
1 1/4" DIA  
1 1/8" PROJ



## STICKLEY MISSION I

SOLID BRASS  
PYRAMID HEAD SCREW (INCLUDED)



**D526**  
BRASS  
3 3/4" X 1 1/4"



**D526-BL**  
BLACK IRON  
3 3/4" X 1 1/4"



**D526-AE**  
ANTIQUE ENGLISH  
3 3/4" X 1 1/4"



**D525**  
BRASS  
1 1/2" X 3 1/8"



**D525-BL**  
BLACK IRON  
1 1/2" X 3 1/8"



**D525-AE**  
ANTIQUE ENGLISH  
1 1/2" X 3 1/8"



**D542-AC**  
ANTIQUÉ COPPER  
1 3/16" SQ  
7/8" PROJ

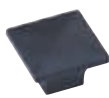

**D522-BL**  
BLACK  
1 1/4" SQ  
7/8" PROJ



**D524-BI**  
BLACK CAST IRON  
1 1/8" SQ  
7/8" PROJ

ITEM	1+	25+	100+
D522-BL	\$2.95	\$2.25	\$1.75
D524-BI	\$2.95	\$2.25	\$1.75
D525	\$5.78	\$5.05	\$4.75
D525-AE	\$5.78	\$5.05	\$4.75
D525-BL	\$6.25	\$5.67	\$4.75
D526	\$5.78	\$5.05	\$4.75
D526-AE	\$5.78	\$5.05	\$4.75
D526-BL	\$6.25	\$5.67	\$4.75
D542-AC	\$4.73	\$4.07	\$3.50

## HAMMERED MISSION



**D550**  
ANTIQUÉ COPPER  
1 3/4" X 3 1/2"  
3" C/C



**D550-A**  
BLACK  
1 3/4" X 3 1/2"  
3" C/C

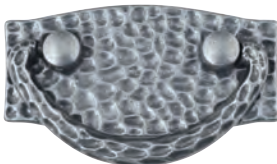

**D550-B**  
PEWTER  
1 3/4" X 3 1/2"  
3" C/C



**D551**  
ANTIQUÉ COPPER  
3 1/2" X 1 3/4"



**D551-B**  
PEWTER  
3 1/2" X 1 3/4"

ITEM	1+	25+	100+
D550	\$3.50	\$2.95	\$2.25
D550-A	\$3.50	\$2.95	\$2.65
D550-B	\$3.50	\$2.95	\$2.65
D551	\$3.50	\$2.95	\$2.65
D551-B	\$3.50	\$2.95	\$2.65

## ELEGANT ART



**D560-AP**  
ANTIQUÉ PEWTER  
1 1/4" X 3 3/4"  
2 1/8" C/C



**D561-AP**  
ANTIQUÉ PEWTER  
3 3/4" X 1 1/4"

ITEM	1+	25+	100+
D560-AP	\$4.25	\$3.75	\$3.50
D561-AP	\$4.25	\$3.75	\$3.50

## LIBERTY MISSION



**K8005**  
BLACK IRON  
1 1/2" X 4 7/8"  
4 1/4" C/C



**K8006**  
BLACK IRON  
4 7/8" X 1 1/2"  
4 1/4" C/C

ITEM	1+	25+	100+
<b>K8005</b>	\$2.95	\$2.45	\$1.95
<b>K8006</b>	\$2.95	\$2.45	\$1.95

## BIRDCAGE



**K1350-DACM**  
DARK BRUSHED  
COPPER MACHINED  
2 1/4" L  
1 3/8" PROJ



**K1350-SIM**  
PEWTER  
2 1/4" L  
1 3/8" PROJ

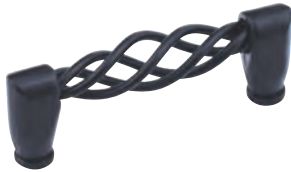

**K1300-DACM**  
DARK BRUSHED  
COPPER MACHINED  
3 1/2" L  
3" C/C



**K1300-SIM**  
PEWTER  
3 1/2" L  
3" C/C

ITEM	1+	25+	100+
<b>K1300-DACM</b>	\$3.10	\$2.80	\$2.60
<b>K1300-SIM</b>	\$3.10	\$2.80	\$2.60
<b>K1350-DACM</b>	\$1.75	\$1.55	\$1.45
<b>K1350-SIM</b>	\$1.75	\$1.55	\$1.45

## IRON FORGE



**K58-BL**  
MATTE BLACK  
1 1/2" L  
1 1/4" PROJ



**K558-BL**  
MATTE BLACK  
6" L  
96MM C/C



**K58-SI**  
SWEDISH IRON  
1 1/2" L  
1 1/4" PROJ



**K558-SI**  
SWEDISH IRON  
6" L  
96MM C/C



**K462-BL**  
MATTE BLACK  
4 5/8" L  
96MM C/C



**K462-SIM**  
PEWTER  
4 5/8" L  
96MM C/C

ITEM	1+	25+	100+
<b>K58-BL</b>	\$2.25	\$1.90	\$1.65
<b>K58-SI</b>	\$2.25	\$1.90	\$1.65
<b>K462-BL</b>	\$4.35	\$3.85	\$3.30
<b>K462-SIM</b>	\$4.35	\$3.85	\$3.30
<b>K558-BL</b>	\$3.85	\$3.25	\$2.65
<b>K558-SI</b>	\$3.85	\$3.25	\$2.65

## OLD WORLD



**K530-W**  
WINDOWOVER ANTIQUE  
1 3/4" X 1 1/4"  
1 1/4" PROJ



**K089-W**  
WROUGHT IRON  
4 3/4" L  
3 5/8" C/C



**K570-W**  
WROUGHT IRON  
1" DIA  
3/4" PROJ



**K3248-W**  
WROUGHT IRON  
1" DIA  
7/8" PROJ



**K1814-W**  
WROUGHT IRON  
3/4" DIA  
3/4" PROJ



**K3222-W**  
WROUGHT IRON  
1 7/8" X 1 7/16"  
5/8" PROJ

ITEM	1+	25+	100+
<b>K089-W</b>	\$2.50	\$1.95	\$1.75
<b>K530-W</b>	\$2.50	\$2.00	\$1.75
<b>K570-W</b>	\$1.85	\$1.60	\$1.45
<b>K1814-W</b>	\$1.95	\$1.70	\$1.50
<b>K3222-W</b>	\$2.25	\$1.95	\$1.65
<b>K3248-W</b>	\$1.95	\$1.70	\$1.50

# RUSTIC

# H-Select



**K3272-DACM**  
DARK BRUSHED  
COPPER MACHINED  
1 3/16" L  
1 1/4" PROJ



**K3273-DACM**  
DARK BRUSHED  
COPPER MACHINED  
4 1/2" L  
96MM C/C



**K3031-DACM**  
DARK BRUSHED COPPER MACHINED  
2" DIA  
1 1/8" PROJ

ITEM	1+	25+	100+
K3031-DACM	\$2.05	\$1.70	\$1.45
K3272-DACM	\$1.95	\$1.85	\$1.65
K3273-DACM	\$3.95	\$3.50	\$2.95

# WILLOW



**K329-LP**  
LANCASTER ANTIQUE  
3" X 4"  
3" C/C



**K8018-LP**  
LANCASTER ANTIQUE  
1 7/8" X 1 1/2"

ITEM	1+	25+	100+
K321-LP	\$2.75	\$2.35	\$2.10
K326-LP	\$4.00	\$3.65	\$3.10
K329-LP	\$6.95	\$6.25	\$5.50
K8018-LP	\$2.56	\$2.19	\$1.97



**K321-LP**  
LANCASTER ANTIQUE  
1 1/8" L  
1" PROJ



**BACKPLATE**  
**K326-LP**  
LANCASTER ANTIQUE  
1" X 5 1/2"

# SOLID BRASS



**K6641-SN**  
SATIN NICKEL  
3/4" DIA  
3/4" PROJ



**K6640**  
POLISHED BRASS  
5/8" DIA  
5/8" PROJ



**K6641**  
POLISHED BRASS  
3/4" DIA  
3/4" PROJ



**K6641-A**  
BLACK  
3/4" DIA  
3/4" PROJ

ITEM	1+	25+	100+
K15	\$4.75	\$4.35	\$3.45
K1884	\$2.50	\$2.15	\$1.85
K1908	\$5.95	\$5.40	\$4.95
K38	\$3.40	\$2.95	\$2.25
K39	\$5.46	\$4.97	\$4.35
K6640	\$2.10	\$1.65	\$1.40
K6641	\$2.10	\$1.65	\$1.40
K6641-A	\$2.10	\$1.65	\$1.40
K6641-SN	\$2.10	\$1.65	\$1.40



**MOCK KEY**  
**K1884**  
POLISHED BRASS  
1 1/8" L  
1" PROJ



**K1908**  
POLISHED BRASS  
4" X 4"  
3" C/C



**K15**  
POLISHED BRASS  
4" L  
3" C/C



**K38**  
POLISHED BRASS  
3/4" X 5 1/4"



**BACKPLATE**  
**K39**  
POLISHED BRASS  
7/8" X 6 3/4"

**MOCK KEY**  
**K1884**  
POLISHED BRASS  
1 1/8" L  
1" PROJ

H-SELECT

# H-Select

## TRANQUIL



**K5302-AB**  
ANTIQUE BRASS/ WHITE  
1 1/4" DIA  
1" PROJ



**K5302-AB-O**  
ANTIQUE BRASS/ OAK  
1 1/4" DIA  
1" PROJ



**K5302-PB**  
POLISHED BRASS/ WHITE  
1 1/4" DIA  
1" PROJ



**K5302-PB-O**  
POLISHED BRASS/ OAK  
1 1/4" DIA  
1" PROJ



**P226**  
OATMEAL  
1 1/4" DIA  
7/8" PROJ



**P220**  
WHITE  
1" DIA  
1" PROJ



**P225**  
WHITE  
1 1/4" DIA  
7/8" PROJ



**K5312-AB**  
ANTIQUE BRASS/ WHITE  
5" L  
3" C/C



**K5312-AB-O**  
ANTIQUE BRASS/ OAK  
5" L  
3" C/C



**K5312-PB**  
POLISHED BRASS/ WHITE  
5" L  
3" C/C



**K5312-PB-O**  
POLISHED BRASS/ OAK  
5" L  
3" C/C

ITEM	1+	25+	100+
<b>K5302-AB</b>	\$2.00	\$1.60	\$1.25
<b>K5302-AB-O</b>	\$2.00	\$1.60	\$1.25
<b>K5302-PB</b>	\$2.00	\$1.60	\$1.25
<b>K5302-PB-O</b>	\$2.00	\$1.60	\$1.25
<b>K5312-AB</b>	\$2.50	\$2.00	\$1.50
<b>K5312-AB-O</b>	\$2.50	\$2.00	\$1.50
<b>K5312-PB</b>	\$2.50	\$2.00	\$1.50
<b>K5312-PB-O</b>	\$2.50	\$2.00	\$1.50
<b>P220</b>	\$1.25	\$1.15	\$0.95
<b>P225</b>	\$1.25	\$0.99	\$0.85
<b>P226</b>	\$1.25	\$0.99	\$0.85

H-SELECT

## PALISADE



**K235**  
POLISHED BRASS PLATED  
5" L  
3" C/C



**K3211-PB**  
BRASS PLATED  
4 7/8" L  
3" C/C



**K3211-SN**  
SATIN NICKEL  
4 7/8" L  
3" C/C



**K2910-SN**  
SATIN NICKEL  
4 7/8" L  
3" C/C

ITEM	1+	25+	100+
<b>K235</b>	\$2.89	\$2.47	\$1.80
<b>K3211-PB</b>	\$2.89	\$2.47	\$1.80
<b>K3211-SN</b>	\$2.89	\$2.47	\$1.80
<b>K2910-SN</b>	\$2.35	\$1.95	\$1.65

## SHAKER KNOBS

- COMES WITH INSERTS
- END GRAIN



**KR15-OAK**  
OAK  
**KR15-C**  
CHERRY  
**KR15-M**  
MAPLE  
**KR15-W**  
WALNUT  
1 1/16" DIA  
1 1/16" PROJ



**KR15-BL**  
BLACK PAINT  
1 1/16" DIA  
1 1/16" PROJ

ITEM	1+	100+	500+
<b>KR15-OAK</b>	\$0.79	\$0.65	\$0.58
<b>KR15-BL</b>	\$0.90	\$0.75	\$0.68
<b>KR15-C</b>	\$0.80	\$0.66	\$0.60
<b>KR15-M</b>	\$0.79	\$0.65	\$0.58
<b>KR15-W</b>	\$0.83	\$0.70	\$0.63

ORDER SCREWS SEPARATELY

## MISSION

- COMES WITH INSERTS
- USE 8/32 BOLTS



**K49-D**  
OAK  
1 3/4" SQ

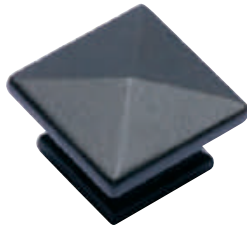

**K49-B**  
OAK  
1 1/4" SQ  
**K49-BC**  
CHERRY  
1 1/4" SQ  
**K52-B**  
WALNUT  
1 1/4" SQ  
**K53-BL**  
BLACK  
1 1/4" SQ

ITEM	1+	100+
<b>K49-B</b>	\$0.95	\$0.80
<b>K49-BC</b>	\$1.00	\$0.85
<b>K49-D</b>	\$1.20	\$1.00
<b>K52-B</b>	\$1.00	\$0.85
<b>K53-BL</b>	\$1.00	\$0.85

ORDER SCREWS SEPARATELY

## PREMIUM MISSION

- COMES WITH INSERTS
- USE 8/32 BOLTS



**K50-B**  
OAK  
1 1/4" SQ  
**K51-B**  
CHERRY  
1 1/4" SQ  
**K54-B**  
MAPLE  
1 1/4" SQ



**K50-C**  
OAK  
1 1/2" SQ  
**K51-C**  
CHERRY  
1 1/2" SQ  
**K54-C**  
MAPLE  
1 1/2" SQ



**K49-H**  
OAK  
3" C/C

ITEM	1+	100+	500+
<b>K49-H</b>	\$2.50	\$1.95	-
<b>K50-B</b>	\$0.95	\$0.85	\$0.75
<b>K50-C</b>	\$1.05	\$0.95	\$0.85
<b>K51-B</b>	\$1.05	\$0.95	\$0.90
<b>K51-C</b>	\$1.15	\$1.05	\$0.90
<b>K54-B</b>	\$1.10	\$1.00	\$0.85
<b>K54-C</b>	\$1.15	\$1.05	\$0.90

## DIAMOND MISSION

- USE WITH MISSION OR ANY OTHER CUSTOM DESIGNS
- COMES WITH INSERTS



**DIAMOND SHAPED WOOD KNOB WITH DIAMOND FACE**

**K70**  
WALNUT  
1 1/2" X 2"  
**K70-A**  
OAK  
1 1/2" X 2"

ITEM	1+	100+
<b>K70</b>	\$1.85	\$1.40
<b>K70-A</b>	\$1.25	\$0.95

## WOOD KNOBS I

- COMES WITH INSERTS
- FACE GRAIN
- USE 8/32 BOLTS



**K40-A**  
OAK  
1" DIA

**K45-A**  
CHERRY  
1" DIA

**K47-A**  
OAK  
1" DIA

**K41-A**  
BEECH  
1" DIA

**K46-A**  
WALNUT  
1" DIA



**K40-B**  
OAK  
1 1/4" DIA



**K47-B**  
OAK  
1 1/4" SQ



**K40-C**  
OAK  
1 1/2" DIA



**K47-C**  
OAK  
1 1/2" SQ

**K41-B**  
BEECH  
1 1/4" DIA

**K48-B**  
CHERRY  
1 1/4" SQ

**K41-C**  
BEECH  
1 1/2" DIA

**K44-B**  
HICKORY  
1 1/4" DIA

**K45-C**  
CHERRY  
1 1/2" DIA

**K45-B**  
CHERRY  
1 1/4" DIA

**K46-C**  
WALNUT  
1 1/2" DIA

**K46-B**  
WALNUT  
1 1/4" DIA

**K55-C**  
MAPLE  
1 1/2" DIA

**K55-B**  
MAPLE  
1 1/4" DIA

**K56-C**  
QTR. SAWN W. OAK  
1 1/2" DIA

**K56-B**  
QTR. SAWN W. OAK  
1 1/4" DIA

**K57-B**  
GRAY ELM  
1 1/4" DIA

ITEM	1+	100+	500+
<b>K40-A</b>	\$0.65	\$0.57	\$0.51
<b>K40-B</b>	\$0.68	\$0.60	\$0.54
<b>K40-C</b>	\$0.70	\$0.62	\$0.55
<b>K41-A</b>	\$0.53	\$0.47	\$0.42
<b>K41-B</b>	\$0.58	\$0.51	\$0.46
<b>K41-C</b>	\$0.60	\$0.53	\$0.47
<b>K44-B</b>	\$1.30	\$1.10	\$0.93
<b>K45-A</b>	\$0.70	\$0.62	\$0.55
<b>K45-B</b>	\$0.85	\$0.75	\$0.68
<b>K45-C</b>	\$0.88	\$0.78	\$0.70
<b>K46-A</b>	\$0.75	\$0.60	-
<b>K46-B</b>	\$1.05	\$0.95	\$0.85
<b>K46-C</b>	\$0.95	\$0.85	\$0.75
<b>K47-A</b>	\$0.60	\$0.49	-
<b>K47-B</b>	\$0.65	\$0.55	-
<b>K47-C</b>	\$0.75	\$0.60	-
<b>K48-B</b>	\$0.90	\$0.75	-
<b>K55-B</b>	\$0.90	\$0.80	\$0.72
<b>K55-C</b>	\$0.95	\$0.85	\$0.76
<b>K56-B</b>	\$0.95	\$0.85	\$0.75
<b>K56-C</b>	\$0.95	\$0.85	\$0.75
<b>K57-B</b>	\$0.95	\$0.85	\$0.75

ORDER SCREWS SEPARATELY

H-SELECT

## WOOD KNOBS II

- COMES WITH INSERTS
- FACE GRAIN



### OVAL SHAPED WOOD KNOB

**K114-M**  
MAPLE  
1 7/8" X 1 1/2"  
1 1/16" PROJ

**K114-W**  
WALNUT  
1 7/8" X 1 1/2"  
1 1/16" PROJ

ITEM	1+	100+
<b>K114-O</b>	\$1.25	\$0.90
<b>K114-M</b>	\$1.25	\$0.90
<b>K114-W</b>	\$1.25	\$0.90

ORDER SCREWS SEPARATELY

## WOOD KNOBS IV



**K4275**  
OAK  
1 3/8" DIA



**K4277**  
OAK  
1 3/4" DIA



**K4278**  
OAK  
2" DIA

**K4375**  
WALNUT  
1 3/8" DIA

**K4377**  
WALNUT  
1 3/4" DIA

**K4378**  
WALNUT  
2" DIA

ITEM	1+	100+
<b>K4275</b>	\$1.20	\$0.80
<b>K4277</b>	\$1.20	\$1.00
<b>K4278</b>	\$1.60	\$1.30
<b>K4375</b>	\$1.20	\$0.90
<b>K4377</b>	\$1.40	\$1.20
<b>K4378</b>	\$1.70	\$1.40

ORDER SCREWS SEPARATELY

# H-Select

## WOOD HANDLES



**BBW1**  
OAK  
5 1/2" C/C, 7" W X 1 3/8" H



**BBW8**  
OAK  
3 3/4" C/C, 4 1/2" W X 7/8" H



**BBW2**  
OAK  
3 1/2" C/C, 5" W X 1 3/8" H



**BBW9**  
OAK  
3 3/4" C/C, 4 1/4" W X 1 3/4" H  
**BBW9-A**  
CHERRY  
3 3/4" C/C, 4 1/4" W X 1 3/4" H



**BBW4**  
OAK  
5 1/2" C/C, 7" W X 1 3/8" H



**BBW12**  
OAK  
3" C/C, 5 1/2" W



**BBW5**  
OAK  
3 3/4" C/C, 5" W X 1 3/8" H



**BBW15**  
OAK  
5" C/C, 7 1/4" W

**BBW5-A**  
CHERRY  
3 3/4" C/C, 5" W X 1 3/8" H

ITEM	1+	100+
<b>BBW1</b>	\$4.00	\$3.50
<b>BBW2</b>	\$3.75	\$2.70
<b>BBW2-A</b>	\$4.50	\$4.25
<b>BBW4</b>	\$3.50	\$2.70
<b>BBW5</b>	\$3.50	\$2.50
<b>BBW5-A</b>	\$4.00	\$3.00
<b>BBW8</b>	\$2.50	\$1.80
<b>BBW9</b>	\$2.50	\$1.40
<b>BBW9-A</b>	\$2.75	\$2.25
<b>BBW12</b>	\$4.95	\$4.25
<b>BBW15</b>	\$3.50	\$2.50

ORDER SCREWS SEPARATELY

H-SELECT

## HOOKS



**Q15** SOLID BRASS 5" H  
BASE 2" X 1 1/8"  
**Q15-F** BLACK 5" H  
BASE 2" X 1 1/8"  
**Q30** ANTIQUE BRASS 5" H  
BASE 2 3/8" X 7/16"  
**Q34** BLACK 5 1/2" H  
BASE 2" X 1 1/16"  
**Q4** SOLID BRASS 4 1/2" H  
BASE 1 3/8" X 1 1/4"  
**Q4-F** BLACK 4 1/2" H  
BASE 1 3/8" X 1 1/4"

ITEM	1+	25+	100+	500+
<b>Q15</b>	\$7.75	\$7.00	\$6.50	-
<b>Q15-F</b>	\$2.95	\$2.65	\$2.00	\$1.85
<b>Q30</b>	\$2.50	\$2.15	\$1.85	-
<b>Q34</b>	\$2.75	\$2.45	\$1.95	\$1.75
<b>Q4</b>	\$6.75	\$6.25	\$5.95	-
<b>Q4-F</b>	\$2.95	\$2.60	\$1.99	-

## ARTS AND CRAFTS

## OLD CLASSIC

ITEM	1+	25+	100+
<b>Q351</b>	\$8.75	\$7.85	\$7.35
<b>Q351-A</b>	\$8.75	\$7.85	\$7.35
<b>Q351-B</b>	\$8.75	\$7.85	\$7.35



**Q351**  
SOLID BRASS  
5 1/2" H  
BASE 2 1/4" X 9/16"



**Q351-A**  
OIL-RUBBED BRONZE  
5 1/2" H  
BASE 2 1/4" X 9/16"



**Q351-B**  
SATIN NICKEL  
5 1/2" H  
BASE 2 1/4" X 9/16"

ITEM	1+	25+	100+	500+
<b>Q31</b>	\$2.90	\$2.50	\$1.99	\$1.80
<b>Q32-BL</b>	\$2.90	\$2.50	\$1.99	\$1.80
<b>Q33</b>	\$2.90	\$2.50	\$1.99	\$1.80



**Q31**  
ANTIQUÉ BRASS  
5 1/2" H  
BASE 1 1/2" X 1 3/4"



**Q32-BL**  
FLAT BLACK  
5 1/2" H  
BASE 1 1/2" X 1 3/4"



**Q33**  
BRASS  
5 1/2" H  
BASE 1 1/2" X 1 3/4"

## RETRO



**Q29**  
BRASS  
5 1/2" H  
BASE 1 3/4" X 1"



**Q29-AE**  
ANTIQUÉ ENGLISH  
5 1/2" H  
BASE 1 3/4" X 1"



**Q29-BL**  
BLACK  
5 1/2" H  
BASE 1 3/4" X 1"



**Q29-ORB**  
OIL-RUBBED  
BRONZE  
5 1/2" H  
BASE 1 3/4" X 1"



**Q29-SN**  
SATIN NICKEL  
5 1/2" H  
BASE 1 3/4" X 1"

ITEM	1+	25+	100+	500+
<b>Q29</b>	\$2.35	\$1.95	\$1.65	\$1.50
<b>Q29-AE</b>	\$2.35	\$1.95	\$1.65	\$1.50
<b>Q29-BL</b>	\$2.35	\$1.95	\$1.65	\$1.50
<b>Q29-ORB</b>	\$2.35	\$1.95	\$1.65	\$1.50
<b>Q29-SN</b>	\$2.35	\$1.95	\$1.65	\$1.50

## JEWELRY HOOKS



**KB3**  
ANTIQUÉ BRASS  
1 1/2" H  
BASE 1 1/4" X 5/8"



**KB3-SN**  
SATIN NICKEL  
1 1/2" H  
BASE 1 1/4" X 5/8"



**KB3-BL**  
BLACK  
1 1/2" H  
BASE 1 1/4" X 5/8"



**Q96-BL**  
BLACK  
1 1/2" H  
BASE 1 3/8" X 3/4"



**Q96-ORB**  
OIL-RUBBED BRONZE  
1 1/2" H  
BASE 1 3/8" X 3/4"



**Q96-SN**  
SATIN NICKEL  
1 1/2" H  
BASE 1 3/8" X 3/4"

ITEM	1+	25+	100+	250+
<b>KB3</b>	\$1.05	\$0.80	\$0.55	\$0.47
<b>KB3-SN</b>	\$1.05	\$0.80	\$0.55	\$0.47
<b>KB3-BL</b>	\$1.05	\$0.80	\$0.55	\$0.47
<b>Q96-BL</b>	\$1.15	\$1.05	\$0.90	\$0.75
<b>Q96-ORB</b>	\$1.15	\$1.05	\$0.90	\$0.75
<b>Q96-SN</b>	\$1.15	\$1.05	\$0.90	\$0.75

## COUNTRY LATCHES



**D1618-AB**  
ANTIQUÉ BRASS  
LATCH ~ 2 1/8" X 1 1/2"  
CATCH ~ 2 1/8" X 5/8"



**D1618-PB**  
POLISHED BRASS  
LATCH ~ 2 1/8" X 1 1/2"  
CATCH ~ 2 1/8" X 5/8"



**D3618-AC**  
ANTIQUÉ COPPER  
LATCH ~ 2 1/8" X 1 1/2"  
CATCH ~ 2 1/8" X 5/8"



**D7618-PN**  
NICKEL  
LATCH ~ 2 1/8" X 1 1/2"  
CATCH ~ 2 1/8" X 5/8"



**D8618-ORB**  
OIL-RUBBED BRONZE  
LATCH ~ 2 1/8" X 1 1/2"  
CATCH ~ 2 1/8" X 5/8"

ITEM	1+
<b>D1618-AB</b>	\$5.20
<b>D1618-PB</b>	\$5.20
<b>D1618-AC</b>	\$5.20
<b>D1618-PN</b>	\$5.20
<b>D1618-ORB</b>	\$5.20



## DESK CARD HOLDERS



**F1401**  
STAMPED BRASS  
1 1/4" X 2 3/8"



**F1403**  
STAMPED BRASS  
1 1/2" X 3 1/8"

ITEM	1+	25+
F1401	\$2.25	\$1.95
F1403	\$2.75	\$2.35
FF6	\$1.85	\$1.55
FF6-BL	\$2.50	\$2.25
FF6-SN	\$2.50	\$2.25



**FF6**  
POLISHED BRASS  
1" X 2 1/4"  
11/16" PROJ  
■ SOLID BRASS



**FF6-BL**  
BLACK  
1" X 2 1/4"  
11/16" PROJ  
■ SOLID BRASS



**FF6-SN**  
SATIN NICKEL  
1" X 2 1/4"  
11/16" PROJ  
■ SOLID BRASS

## GROMMETS



**BG1-PB**  
POLISHED BRASS  
2 1/2" HOLE  
3" DIA



**BG2-PBL**  
PLASTIC BLACK  
2 1/2" HOLE  
3" DIA



**BG3-PB**  
POLISHED BRASS  
1 9/16" HOLE  
2" DIA



**BG4-SN**  
BRUSHED NICKEL  
2 1/2" HOLE  
3" DIA



**BG5-BL**  
BLACK  
1 9/16" HOLE  
2" DIA



**BG6-SN**  
BRUSHED NICKEL  
2 1/2" HOLE  
3" DIA



**BG7-O**  
OAK  
2 1/2" HOLE  
3" DIA



**BG8-M**  
MAPLE  
2 1/2" HOLE  
3" DIA



**BG9-BL**  
BLACK  
2 1/2" HOLE  
3" DIA

ITEM	1+	25+	100+
BG1-PB	\$2.95	\$2.75	\$2.25
BG2-PBL	\$2.50	\$2.00	\$1.75
BG3-PB	\$2.50	\$1.95	\$1.75
BG4-SN	\$3.50	\$3.00	\$2.75
BG5-BL	\$2.50	\$1.95	\$1.75
BG6-SN	\$2.50	\$1.95	\$1.75
BG7-O	\$3.50	\$3.25	\$2.95
BG8-M	\$3.50	\$3.25	\$2.95
BG9-BL	\$3.00	\$2.50	\$2.25

## KEY HOLES



**E1-AE**  
STAMPED BRASS  
1" DIA



**E1-PB**  
STAMPED BRASS  
1" DIA



**E80**  
OAK  
1 1/4" DIA



**E81**  
WALNUT  
1 1/4" DIA



**E3-AE**  
STAMPED BRASS  
1 1/8" X 1 1/2"



**E3-PB**  
STAMPED BRASS  
1 1/8" X 1 1/2"

ITEM	1+	25+
E1-AE	\$1.25	\$1.00
E1-PB	\$1.25	\$1.00
E3-AE	\$1.25	\$1.00
E3-PB	\$1.25	\$1.00
E80	\$1.80	\$1.50
E81	\$1.80	\$1.50

## CHEVEL MIRROR MOUNTS I

### SOLID BRASS CHEVEL MIRROR MOUNT

- INCLUDES 3 1/2" BOLTS W/ FRICTION WASHERS AND NUT

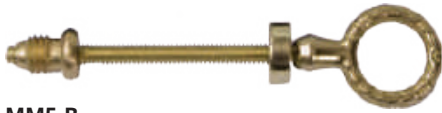

**MM5-B**  
POLISHED BRASS

ITEM	1 PR	25 PR	50 PR
<b>MM5-B</b>	\$7.50	\$6.50	\$6.00

## CHEVEL MIRROR MOUNTS II

### ZINC DIE CAST CHEVEL MIRRORS MOUNTS

- 2 1/2" BOLTS COMES W/ FRICTION WASHERS AND NUT



**M6-AB**  
ANTIQU BRASS



**M6-BL**  
BLACK



**M6-SN**  
SATIN NICKEL

ITEM	1 PR	25 PR	50 PR
<b>M6-AB</b>	\$3.75	\$3.45	\$3.00
<b>M6-BL</b>	\$3.75	\$3.45	\$3.00
<b>M6-SN</b>	\$4.50	\$4.15	\$3.75

H-SELECT

## BIFOLD LOCKING HINGES



**VBF10**  
2 1/2" H X 2 1/4" W

- LOCKS OPEN OR CLOSED DOORS
- HEAVY DUTY CONSTRUCTION

ITEM	1+	25+	100+
<b>VBF10</b>	\$2.75	\$2.35	\$1.95

## DECORATIVE HINGES - NON SELF-CLOSING

- FULL WRAP AROUND HINGE - FULL INSET
- FOR 3/4" FRAME & 3/4" DOOR, 270° OPENING
- STYLISH TIPS FOR SHAKER STYLE CABINETS WITH RAISED PANEL DOORS
- NON-MORTISE HINGE QUICKLY INSTALLS & YIELDS MINIMAL DOOR GAP
- #6 X 5/8" FLAT HEAD SCREW RECOMMENDED FOR ATTACHMENT TO FRAME AND #6 X 1/2" FLAT HEAD SCREW RECOMMENDED FOR DOOR ATTACHMENT
- SLOTTED HOLES PROVIDE HORIZONTAL & VERTICAL ADJUSTMENT



**BALL TIP FULL WRAP AROUND HINGE - FULL INSET**

- V0128-AB**  
ANTIQU BRASS  
**V0128-DBAC**  
DARK BRUSHED ANTIQU COPPER  
**V0128-MB**  
MATTE BLACK  
**V0128-SN**  
SATIN NICKEL



**MINARET TIP PARTIAL WRAP AROUND HINGE - FULL INSET**

- V0148-AB**  
ANTIQU BRASS  
**V0148-DBAC**  
DARK BRUSHED ANTIQU COPPER  
**V0148-MB**  
MATTE BLACK  
**V0148-SN**  
SATIN NICKEL



**MINARET TIP FULL WRAP AROUND HINGE - FULL INSET**

- V0138-DBAC**  
DARK BRUSHED ANTIQU COPPER  
**V0138-MB**  
MATTE BLACK  
**V0138-SN**  
SATIN NICKEL

ITEM	1+	100+	250+
<b>V0128-AB</b>	\$1.35	\$1.10	\$0.99
<b>V0128-DBAC</b>	\$1.35	\$1.10	\$0.99
<b>V0128-MB</b>	\$1.35	\$1.10	\$0.99
<b>V0128-SN</b>	\$1.35	\$1.20	\$1.10
<b>V0138-DBAC</b>	\$1.35	\$1.10	\$0.99
<b>V0138-MB</b>	\$1.35	\$1.10	\$0.99
<b>V0138-SN</b>	\$1.35	\$1.20	\$1.10
<b>V0148-AB</b>	\$1.35	\$1.10	\$0.99
<b>V0148-DBAC</b>	\$1.35	\$1.10	\$0.99
<b>V0148-MB</b>	\$1.35	\$1.10	\$0.99
<b>V0148-SN</b>	\$1.35	\$1.20	\$1.10

## H HINGES



**V15-BL**  
BLACK  
1 1/2" X 3 1/2"  
■ INCLUDES SCREWS



**V16-AB**  
ANTIQUE BRASS  
1 1/2" X 3 1/2"

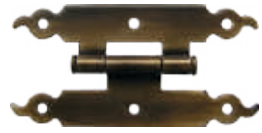

**V19-AE**  
ANTIQUE ENGLISH  
1 1/2" X 3 1/2"

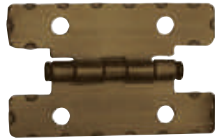

**V25-AE**  
ANTIQUE ENGLISH  
2 1/2" H



**V25-BL**  
BLACK  
2 1/2" H



**V149-AE**  
ANTIQUE ENGLISH  
1 1/2" X 1 1/2"  
■ FINIAL TIP

ITEM	1+	25+	100+	250+	500+	1000+
V149-AE	\$1.95	\$1.50	\$1.15	\$1.00	\$0.95	-
V15-BL	\$0.95	\$0.80	\$0.65	\$0.50	\$0.40	-
V16-AB	\$0.95	\$0.80	\$0.65	\$0.50	\$0.40	-
V19-AE	\$1.25	\$0.95	\$0.85	\$0.75	-	-
V25-AE	\$1.00	\$0.90	\$0.75	\$0.65	\$0.60	\$0.55
V25-BL	\$1.00	\$0.85	\$0.70	\$0.60	\$0.55	\$0.48

## HINGE I

### SELF CLOSING SPRING



**V11-AB**  
ANTIQUE BRASS  
3/8" INSET



**V14-PB**  
POLISHED BRASS  
3/8" INSET



**V30-AE**  
ANTIQUE ENGLISH  
3/8" INSET

ITEM	SOLD IN	1 PR	25 PR	100 PR
V11-AB	PAIRS	\$1.85	\$1.50	\$1.35
V14-PB	PAIRS	\$1.85	\$1.50	\$1.35
V30-AE	PAIRS	\$2.50	\$2.15	\$1.75
V73-BL	PAIRS	\$2.50	\$2.25	\$1.75



**V73-BL**  
BLACK  
3/8" INSET

## HINGE III

### SELF CLOSING SPRING



**V10**  
POLISHED BRASS  
FLUSH



**V12**  
ANTIQUE BRASS  
FLUSH



**V32-AE**  
ANTIQUE ENGLISH  
FLUSH

ITEM	SOLD IN	1 PR	25 PR	100 PR
V10	PAIRS	\$2.20	\$2.00	\$1.65
V12	PAIRS	\$2.20	\$2.00	\$1.65
V32-AE	PAIRS	\$2.50	\$2.25	\$1.75
V73-A	PAIRS	\$2.50	\$2.25	\$1.75



**V73-A**  
BLACK  
FLUSH

## HINGE IV



**V148-BL**  
BLACK



**V148-SN**  
SATIN NICKEL



**V148-WI**  
WROUGHT IRON

ITEM	1+	25+	100+
V148-BL	\$5.00	\$4.00	\$3.50
V148-SN	\$5.00	\$4.00	\$3.50
V148-WI	\$5.00	\$4.00	\$3.50

## SELF-CLOSING HINGES



**V21-AB**  
ANTIQUE BRASS

- SEMI-CONCEALED
- 3/8" INSET WRAP AROUND



**V22-AB**  
ANTIQUE BRASS  
1/2" OVERLAY

**V22A-AB**  
ANTIQUE BRASS  
1/4" OVERLAY

- WRAP AROUND HINGES
- ADJUSTABLE MOUNTING HOLES

ITEM	SOLD IN	1 PR	25 PR	100 PR
V21-AB	PAIRS	\$3.85	\$3.60	\$3.25
V22-AB	PAIRS	\$2.50	\$2.15	\$1.75
V22A-AB	PAIRS	\$2.50	\$2.15	\$1.75

H-SELECT

## YOUNGDALE KNIFE HINGES



**V120**  
ANTIQUE BRASS  
#4 = 3/8" INSET



**V120-BL**  
BLACK  
#4 = 3/8" INSET



**V120-RB**  
OIL RUBBED BRONZE  
#4 = 3/8" INSET

ITEM	SOLD IN	1 PR	25 PR	100 PR	200 PR
V120	PAIRS	\$2.90	\$2.70	\$2.50	\$2.35
V120-RB	PAIRS	\$2.90	\$2.70	\$2.50	\$2.35
V120-BL	PAIRS	\$3.50	\$3.40	\$3.25	\$2.99
V120-NI	PAIRS	\$2.90	\$2.70	\$2.50	\$2.35
V120-W	PAIRS	\$3.50	\$3.40	\$3.25	\$2.99
V123	PAIRS	\$2.90	\$2.70	\$2.50	\$2.35
V125	PAIRS	\$2.90	\$2.70	\$2.50	\$2.35
V126	PAIRS	\$2.90	\$2.70	\$2.50	\$2.35



**V120-NI**  
NICKEL  
#4 = 3/8" INSET



**V120-W**  
WHITE  
#4 = 3/8" INSET



**V123**  
ANTIQUE BRASS  
#3 = 1/4" OVERLAY



**V125**  
ANTIQUE BRASS  
#5 = 5/16" OVERLAY



**V126**  
ANTIQUE BRASS  
#6 = 1/2" OVERLAY

## FLUSH HINGE

- THREE-WAY ADJUSTABLE
- 90° ANGLE OF OPENING
- 35MM DIAMETER DRILL BIT NEEDED FOR INSTALLATION
- 12MM CUP DEPTH
- SCREWS INCLUDED
- SCREW ON WITH CHIP BOARD SCREWS 3 X 13MM



**V170-AB**  
ANTIQUE BRASS

ITEM	1+	25+
<b>V170-AB</b>	\$3.50	\$3.15

## SEWING MACHINE HINGES



**V50-DAB**  
DARK ANTIQUE BRONZE  
1 1/4" W X 3 1/8" L



**V116-PB**  
POLISHED BRASS  
1 3/16" W X 2 13/16" L



**V116-AE**  
ANTIQUENGLISH  
1 3/16" W X 2 13/16" L



**V100-BZ**  
BRONZE  
1 3/16" W X 2 9/16" L

ITEM	1+	50+
<b>V50-DAB</b>	\$1.25	\$0.95
<b>V116-PB</b>	\$2.85	\$2.25
<b>V116-AE</b>	\$2.85	\$2.25
<b>V100-BZ</b>	\$4.50	\$4.25

## BUTLER TRAY HINGES

- LEAF SPRING LOCKS HINGE AT 90° AND 180°
- SCREWS INCLUDED
- SIZE FULLY OPENED: 1 1/2" HIGH X 2 7/8" WIDE



**V2010**  
HEAVY EXTRUDED BRASS



**V2010-BL**  
BLACK

ITEM	SOLD IN	1 PR	50 PR
<b>V2010</b>	PAIRS	\$11.95	\$10.95
<b>V2010-BL</b>	PAIRS	\$11.95	\$10.95

## NO MORTISE HINGES



**BH16-A**  
ANTIQUENGLISH  
2" H  
**BH16-BL**  
BLACK  
2" H



**V20-DAB**  
DARK ANTIQUE BRONZE  
LID HINGE FOR 3/4" WOOD



**V74-BL**  
BLACK  
3/8" INSET  
**V74-PB**  
POLISHED BRASS  
3/8" INSET

ITEM	1+	25+	100+	200+	500+
<b>BH14-DAB</b>	\$1.25	\$0.90	\$0.80	\$0.70	-
<b>BH15-DAB</b>	\$1.25	\$0.95	\$0.85	\$0.75	-
<b>BH15A-DAB</b>	\$1.70	\$1.50	\$1.45	\$1.30	-
<b>BH16-A</b>	\$1.00	\$0.85	\$0.75	\$0.60	-
<b>BH16-BL</b>	\$1.00	\$0.85	\$0.75	\$0.60	-
<b>V20-DAB</b>	\$1.95	\$1.75	-	-	-
<b>V74-BL</b>	\$1.50	\$1.40	\$1.25	\$0.95	\$0.95
<b>V74-PB</b>	\$1.50	\$1.40	\$1.25	\$0.95	\$0.95



**BH14-DAB**  
2" H LARGE LEAF 7/8" W  
**BH15-DAB**  
2 1/2" H LARGE LEAF 1" W  
**BH15A-DAB**  
3" H LARGE LEAF 1 1/16" W  
■ FINIAL TIP

## OVERLAY DOOR HINGE



**V76-BL**  
BLACK

- HINGE FOR 270°
- WILL ALLOW CABINET DOORS TO FOLD AT SIDES

ITEM	1+	25+	100+
<b>V76-BL</b>	\$1.95	\$1.75	\$1.35

## BUTTERFLY HINGE



**H110**  
BRASS PLATED STEEL  
2" H X 2 1/4" L

ITEM	1+	100+
<b>H110</b>	\$1.00	\$0.75

## PIE SAFE TINS

HERSHBERGER'S HARDWARE IS A DISTRIBUTOR FOR IRVIN'S TINS!

- HIGHEST QUALITY PIE SAFE TINS ON THE MARKET
- LACQUERED FINISH, NO PEEL OFF PLASTIC
- FRESH NEW DESIGNS
- SIZE 10" X 14"

ITEM	1+	25+	50+
PST24-C	\$9.25	\$8.75	\$8.25
PST24-BT	\$7.25	\$6.75	\$6.25
PST25-C	\$9.25	\$8.75	\$8.25
PST25-BT	\$7.25	\$6.75	\$6.25
PST26-AT	\$7.25	\$6.75	\$6.25
PST26-BT	\$7.25	\$6.75	\$6.25
PST26-C	\$9.25	\$8.75	\$8.25
PST27-AT	\$7.25	\$6.75	\$6.25
PST27-C	\$9.25	\$8.75	\$8.25

H-SELECT



**FEDERAL STAR**  
PST26-AT  
ANTIQUÉ TIN



**FEDERAL STAR**  
PST26-C  
ANTIQUÉ COPPER



**FEDERAL STAR**  
PST26-BT  
BLACKENED TIN



**3 STAR EMBOSSED**  
PST27-AT  
ANTIQUÉ TIN



**3 STAR EMBOSSED**  
PST27-C  
ANTIQUÉ COPPER



**WHEAT**  
PST24-BT  
BLACKENED TIN



**WHEAT**  
PST24-C  
ANTIQUÉ COPPER



**WHEAT**  
PST25-BT  
BLACKENED TIN



**WHEAT**  
PST25-C  
ANTIQUÉ COPPER

## SELF-ADHESIVE FELT

- GREAT FOR LINING GUN CABINETS, JEWELRY BOXES, ETC. FELT IS EASY-TO-USE
- JUST CUT TO SIZE, PEEL OFF BACK AND STICK IN PLACE!
- AVAILABLE IN FOUR GREAT COLORS
- SOLD BY THE RUNNING FOOT (54" ROLL WIDTH)

ITEM	SOLD BY	1 FT	25 FT
AFBL-4	FOOT	\$6.75	\$6.25
AFBR-2	FOOT	\$6.75	\$6.25
AFGR-1	FOOT	\$6.75	\$6.25
AFRD-3	FOOT	\$6.75	\$6.25



**AFBL-4**  
BLACK  
**AFBR-2**  
BROWN  
**AFGR-1**  
GREEN  
**AFRD-3**  
RED

### CUSTOM ORDERS

- WE WILL ALSO FILL YOUR CUSTOM ORDERS
- GIVE US YOUR SIZE AND WE'LL CUT TO FIT!  
(SQUARE OR ROUNDS ONLY - 100 PIECE MINIMUM)



## CREST

### AVAILABLE FINISHES



**H076127-CH**  
Square Knob  
1 1/4" Dia.



**H076128-CH**  
Round Knob  
1 1/4" Dia.



**H076129-CH**  
3" C/C  
3 1/2" L



**H076130-CH**  
96MM C/C  
4" L



**H076131-CH**  
128MM C/C  
5 9/16" L



**H076132-CH**  
160MM C/C  
6 13/16" L



**H076133-CH**  
192MM C/C  
8 1/16" L



**H076134-CH**  
224MM C/C  
9 5/16" L



**H076135-CH**  
12" C/C  
12 1/2" L

ITEM	1+	25+	100+
<b>H076127</b>	\$3.83	\$3.48	\$2.90
<b>H076128</b>	\$3.71	\$3.38	\$2.81
<b>H076129</b>	\$3.96	\$3.60	\$3.00
<b>H076130</b>	\$5.28	\$4.80	\$4.00
<b>H076131</b>	\$6.20	\$5.64	\$4.70
<b>H076132</b>	\$8.98	\$8.16	\$6.80
<b>H076133</b>	\$11.35	\$10.32	\$8.60
<b>H076134</b>	\$14.93	\$13.58	\$11.31
<b>H076135</b>	\$18.83	\$17.12	\$14.26

BELWITH

## AMERICAN DINER

### AVAILABLE FINISHES



**P2140-SN**  
Small Knob  
1" Dia.



**P2142-SN**  
Large Knob  
1 3/8" Dia.



**P2143-SN**  
3" C/C



**P2141-SN**  
96MM C/C



**P2144-SN**  
3" & 96MM C/C

ITEM	1+	25+	100+
<b>P2140</b>	\$3.43	\$3.12	\$2.60
<b>P2141</b>	\$6.21	\$5.65	\$4.71
<b>P2142</b>	\$4.57	\$4.15	\$3.46
<b>P2143</b>	\$4.75	\$4.33	\$3.60
<b>P2144</b>	\$5.75	\$5.23	\$4.36

NOTE: P2144 is not available in VB Finish.



## GREENWICH

### AVAILABLE FINISHES



14 SS WOA 10B



**P3372-SS**  
Knob  
1 11/16" Dia.



**P3370-SS**  
96MM C/C  
4 1/4" L



**P3371-SS**  
128MM C/C  
6 3/8" L



**P3041-SS**  
224MM C/C  
10" L



**P3374-SS**  
12" C/C  
13 1/4" L



**P3375-SS**  
18" C/C  
19 1/4" L

ITEM	1+	25+	100+
<b>P3041</b>	\$9.26	\$8.42	\$7.01
<b>P3370</b>	\$4.75	\$4.32	\$3.60
<b>P3371</b>	\$6.40	\$5.82	\$4.85
<b>P3373</b>	\$3.76	\$3.42	\$2.85
<b>P3374</b>	\$19.93	\$18.12	\$15.10
<b>P3375</b>	\$36.23	\$32.94	\$27.45

## PIPELINE

### AVAILABLE FINISHES

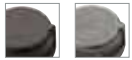

VB BNV



**HH075028**  
1 1/4" Dia.



**HH076013-BNV**  
3" C/C, 3 3/4" L



**HH076011-BNV**  
96mm C/C, 4 1/2" L



**HH076012-BNV**  
128mm C/C, 5 3/4" L



**HH075010-BNV**  
160mm C/C, 7" L

ITEM	1+	25+	100+
<b>HH075010</b>	\$10.11	\$9.19	\$7.65
<b>HH075028</b>	\$4.30	\$3.90	\$3.26
<b>HH076011</b>	\$7.13	\$6.49	\$5.41
<b>HH076012</b>	\$8.51	\$7.74	\$6.45
<b>HH076013</b>	\$5.75	\$5.23	\$4.36

## SKYLIGHT

### AVAILABLE FINISHES



**HH075326-EGN**  
3" C/C  
3 3/8" L

**HH075341-EGN**  
Square Knob  
1 1/4" Dia.

**HH075327-EGN**  
96MM C/C  
4 3/16" L

**HH075328-EGN**  
128MM C/C  
5 7/16" L

**HH075329-EGN**  
160MM C/C  
6 3/4" L

**HH075422-EGN**  
224MM C/C  
9 1/4" L

**HH075336-EGN**  
12" C/C  
12 7/16" L

**HH075337-EGN**  
18" C/C  
18 1/2" L

ITEM	1+	25+	100+
HH075326	\$4.29	\$3.90	\$3.25
HH075327	\$5.28	\$4.80	\$4.00
HH075328	\$6.29	\$5.72	\$4.76
HH075329	\$7.79	\$7.08	\$5.90
HH075336	\$17.16	\$15.60	\$13.00
HH075337	\$24.77	\$22.52	\$18.76
HH075341	\$4.16	\$3.78	\$3.15
HH075422	\$10.18	\$9.26	\$7.71

BELWITH

## EURO CONTEMPORARY

### AVAILABLE FINISHES



**P2163-OBH**  
Square knob  
1 1/2" SQ

**P2164-OBH**  
4" C/C  
7" L

**P2165-OBH**  
128MM C/C  
9" L

ITEM	1+	25+	100+
P2163	\$5.08	\$4.62	\$3.85
P2164	\$6.60	\$6.01	\$5.00
P2165	\$6.74	\$6.14	\$5.11

## FORGE

### AVAILABLE FINISHES

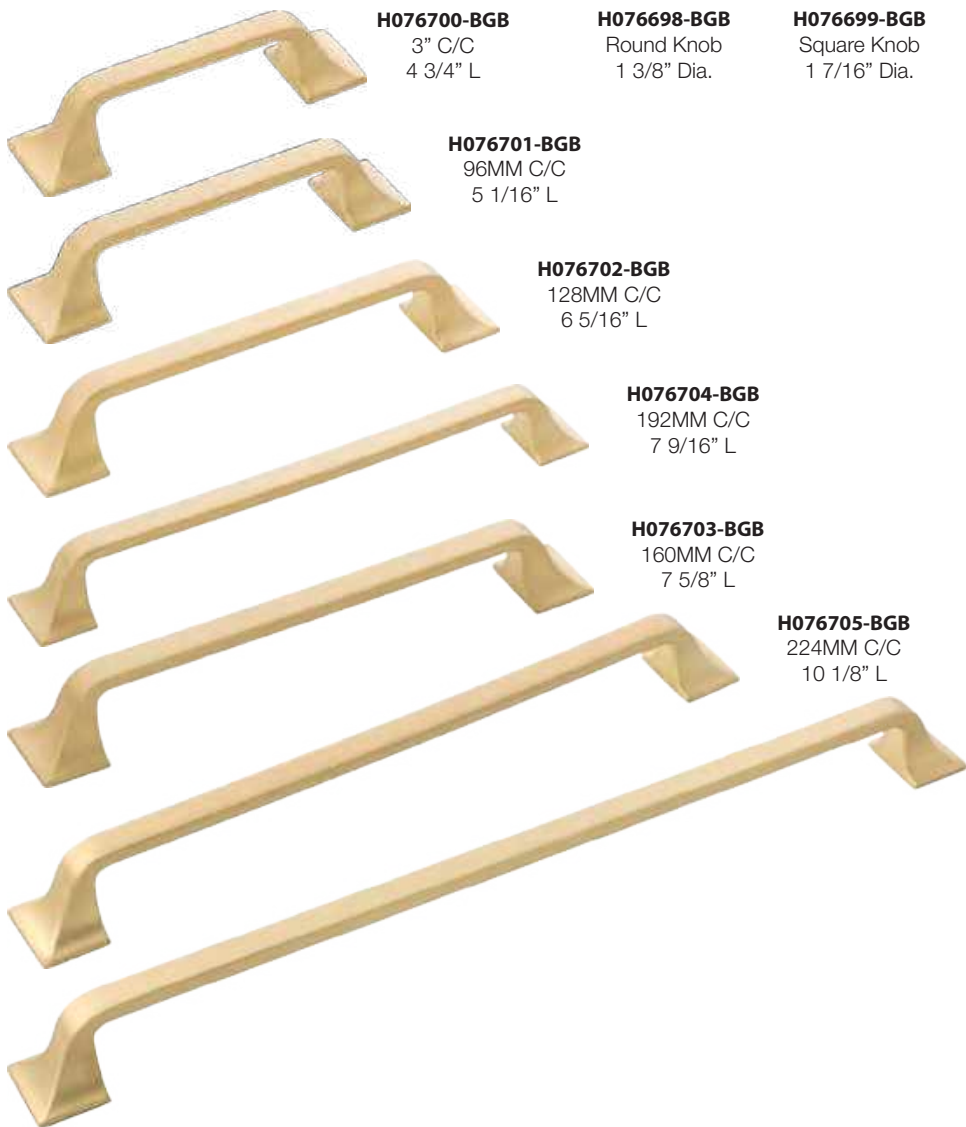

**H076700-BGB**  
3" C/C  
4 3/4" L

**H076698-BGB**  
Round Knob  
1 3/8" Dia.

**H076699-BGB**  
Square Knob  
1 7/16" Dia.

**H076701-BGB**  
96MM C/C  
5 1/16" L

**H076702-BGB**  
128MM C/C  
6 5/16" L

**H076704-BGB**  
192MM C/C  
7 9/16" L

**H076703-BGB**  
160MM C/C  
7 5/8" L

**H076705-BGB**  
224MM C/C  
10 1/8" L

**H076706-BGB**  
12" C/C  
13 3/8" L

ITEM	1+	25+	100+
<b>H076698</b>	\$3.96	\$3.60	\$3.00
<b>H076699</b>	\$4.29	\$3.90	\$3.25
<b>H076700</b>	\$4.62	\$4.20	\$3.50
<b>H076701</b>	\$5.28	\$4.80	\$4.00
<b>H076702</b>	\$6.60	\$6.00	\$5.00
<b>H076703</b>	\$9.26	\$8.42	\$7.01
<b>H076704</b>	\$13.22	\$12.02	\$10.01
<b>H076705</b>	\$19.80	\$18.00	\$15.00
<b>H076706</b>	\$25.08	\$22.80	\$19.00

## MISC. KNOBS

### AVAILABLE FINISHES



**P2712-MB**  
Small Knob  
1" Dia.



**PA1218-MB**  
Large Knob  
1 1/4" Dia.



**P2623-MB**  
32MM C/C



**PA1217-MB**  
Small Knob  
1" Dia.

ITEM	1+	25+	100+
<b>P2712</b>	\$2.43	\$2.22	\$1.85
<b>PA1217</b>	\$2.90	\$2.64	\$2.19
<b>PA1218</b>	\$3.11	\$2.83	\$2.35

NOTE: P2712 is only available in MB Finish.

## LUNA

### AVAILABLE FINISHES



SN MB VB



**P3448-VB**  
3" C/C  
4 1/8" L

ITEM	1+	25+	100+
<b>P3448</b>	\$3.24	\$2.95	\$2.45

## ZEPHYR

### AVAILABLE FINISHES



SN OBH SS



**P2286-SN**  
Small Knob  
1" Dia.



**P2283-SN**  
Large Knob  
1 1/4" Dia.



**P2280-SN**  
3" C/C



**P2281-SN**  
96MM C/C



**P2282-SN**  
128MM C/C

ITEM	1+	25+	100+
<b>P2280</b>	\$4.36	\$3.96	\$3.31
<b>P2281</b>	\$5.15	\$4.68	\$3.90
<b>P2282</b>	\$6.54	\$5.95	\$4.95
<b>P2283</b>	\$5.08	\$4.62	\$3.85
<b>P2286</b>	\$3.96	\$3.61	\$3.01

BELWITH

## METROPOLIS

### AVAILABLE FINISHES

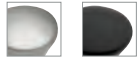

SN MB



**P2922-SN**  
96MM C/C



**P2921-SN**  
2 9/16" C/C



**PA0221-SN**  
96MM C/C, 4 3/4" L



**P3221-SN**  
128MM C/C, 6 3/8" L



**PA0213-SN**  
Small Knob  
1" Dia.



**P7522-SN**  
96MM C/C, 5 1/2" L



**P7523-SN**  
Oblong Knob  
1 5/8" L

ITEM	1+	25+	100+
<b>P2921</b>	\$2.43	\$2.22	\$1.85
<b>P2922</b>	\$3.43	\$3.12	\$2.60
<b>P7522</b>	\$4.75	\$4.33	\$3.60
<b>P7523</b>	\$3.43	\$3.12	\$2.60
<b>PA0213</b>	\$3.43	\$3.12	\$2.60
<b>PA0221</b>	\$3.30	\$3.00	\$2.50

NOTE: PA0221, P3221, P7522 and P7523 are only available in SN Finish.

## ROCHESTER

### AVAILABLE FINISHES



PN SN OBH



**P3112-SN**  
96 MM C/C, 4 1/4" L



**P3114-SN**  
96 MM C/C, 4 1/8" L

ITEM	1+	25+	100+
<b>P3112</b>	\$5.15	\$4.68	\$3.90
<b>P3114</b>	\$4.57	\$4.15	\$3.46

## DECO

### AVAILABLE FINISHES



SN OBH



**P3103-OBH**  
Knob  
1 1/4" Dia.



**P3100-OBH**  
3 1/2" C/C, 4 3/8" L



**P3104-OBH**  
96MM C/C, 4 3/8" L

ITEM	1+	25+	100+
<b>P3100-OBH</b>	\$6.07	\$5.52	\$4.61
<b>P3100-SN</b>	\$6.07	\$5.52	\$4.61
<b>P3103-OBH</b>	\$4.15	\$3.78	\$3.15
<b>P3103-SN</b>	\$4.15	\$3.78	\$3.15
<b>P3104-OBH</b>	\$6.07	\$5.52	\$4.61
<b>P3104-SN</b>	\$6.07	\$5.52	\$4.61

## TWIST

### AVAILABLE FINISHES



BI SN EGN PN CP



**H076014-CP**  
1 1/4" Dia.



**H076015-CP**  
3" C/C  
3 5/8" L



**H076016-CP**  
96mm C/C  
4 7/16" L



**H076017-CP**  
128mm C/C  
5 11/16" L



**H076018-CP**  
160mm C/C  
6 15/16" L



**H076019-CP**  
192mm C/C  
8 1/4" L



**H076020-CP**  
224mm C/C  
9 9/16" L



**H076021-CP**  
12" C/C  
12 11/16" L

ITEM	1+	25+	100+
<b>H076014</b>	\$4.10	\$3.73	\$3.11
<b>H076015</b>	\$4.89	\$4.45	\$3.70
<b>H076016</b>	\$5.75	\$5.23	\$4.36
<b>H076017</b>	\$7.39	\$6.73	\$5.51
<b>H076018</b>	\$10.11	\$9.19	\$7.65
<b>H076019</b>	\$15.65	\$14.23	\$11.86
<b>H076020</b>	\$19.15	\$17.41	\$14.51
<b>H076021</b>	\$26.27	\$23.89	\$19.91

BELWITH

## SOMERSET

### AVAILABLE FINISHES



SN BNV DAC



**74554-DAC**  
1 1/8" SQ

ITEM	1+	25+	100+
<b>74554</b>	\$2.78	\$2.53	\$2.11

## STUDIO

### AVAILABLE FINISHES



**P3010-OBH**  
3" C/C

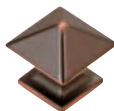

**P3014-OBH**  
Small Knob  
1" SQ

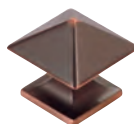

**P3015-OBH**  
Large Knob  
1 1/4" SQ



**P3013-OBH**  
3" & 96MM C/C

ITEM	1+	25+	100+
<b>P3010</b>	\$5.42	\$4.93	\$4.11
<b>P3011</b>	\$6.21	\$5.65	\$4.71
<b>P3013</b>	\$5.94	\$5.40	\$4.50
<b>P3014</b>	\$4.49	\$4.09	\$3.41
<b>P3015</b>	\$4.75	\$4.33	\$3.60

NOTE: P3014 is only available in PN, SN, and OBH Finishes.

## BUNGALOW

### AVAILABLE FINISHES



**P2153-OBH**  
3" & 96MM C/C



**P2150-OBH**  
Small Knob  
1 1/4" L

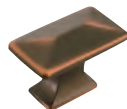

**P2151-OBH**  
Medium Knob  
1 3/4" L

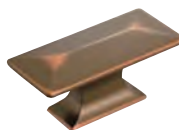

**P2152-OBH**  
Large Knob  
2 5/16" L

ITEM	1+	25+	100+
<b>P2150</b>	\$3.17	\$2.89	\$2.40
<b>P2151</b>	\$4.89	\$4.45	\$3.70
<b>P2152</b>	\$5.02	\$4.58	\$3.81
<b>P2153</b>	\$5.94	\$5.40	\$4.50

BELWITH

## BEDROCK

### AVAILABLE FINISH



DAC



**P3565-DAC**  
3" C/C, 3 1/2" L



**P3564-DAC**  
Round Knob  
1 1/4" Dia.

ITEM	1+	25+	100+
<b>P3564</b>	\$2.90	\$2.64	\$2.19
<b>P3565</b>	\$3.30	\$3.00	\$2.50

## CLOVER CREEK

### AVAILABLE FINISH



DAC



**P3563-DAC**  
3" C/C, 4 7/16" L



**P3562-DAC**  
Round Knob  
1 1/4" Dia.

ITEM	1+	25+	100+
<b>P3562</b>	\$2.64	\$2.40	\$2.01
<b>P3563</b>	\$3.30	\$3.00	\$2.50

## ARTS & CRAFTS

### AVAILABLE FINISHES

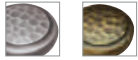

AP WDA



**KNOB**  
**P7528-WDA**  
1 1/4" Dia.

**BACKPLATE**  
**P7529-WDA**  
3 1/2" L X 1" W

ITEM	1+	25+	100+
<b>P7525</b>	\$5.42	\$4.93	\$4.11
<b>P7526</b>	\$4.89	\$4.45	\$3.70
<b>P7527</b>	\$6.07	\$5.52	\$4.61
<b>P7528</b>	\$2.25	\$2.05	\$1.71
<b>P7529</b>	\$1.92	\$1.75	\$1.46



**P7527-WDA**  
3" & 96MM C/C



**P7525-WDA**  
3" & 96MM C/C



**P7526-WDA**  
2 5/8" L

## CRAFTSMAN

### AVAILABLE FINISHES



CH WOA OBH BI



**P2174-WOA**  
96MM C/C



**P2172-WOA**  
Square Knob  
1 1/4" SQ



**P2170-WOA**  
Round Knob  
1 1/4" Dia.

ITEM	1+	25+	100+
<b>P2170</b>	\$4.36	\$3.96	\$3.31
<b>P2171</b>	\$4.62	\$4.20	\$3.49
<b>P2172</b>	\$4.96	\$4.51	\$3.75
<b>P2173</b>	\$5.94	\$5.40	\$4.50
<b>P2174</b>	\$6.07	\$5.52	\$4.61



**P2171-WOA**  
3" C/C



**P2173-WOA**  
96MM C/C

## MOUNTAIN LODGE

### AVAILABLE FINISHES



BI WOA



**P3062-WOA**  
Square Knob  
1 1/4" SQ



**P3063-WOA**  
Round Knob  
1 1/4" Dia.



**P3061-WOA**  
Round Knob  
1 1/4" Dia.

ITEM	1+	25+	100+
<b>P3060</b>	\$5.28	\$4.80	\$4.00
<b>P3061</b>	\$4.89	\$4.45	\$3.70
<b>P3062</b>	\$4.62	\$4.20	\$3.49
<b>P3063</b>	\$4.89	\$4.45	\$3.70
<b>P3064</b>	\$5.94	\$5.40	\$4.50



**P3060-WOA**  
3" C/C

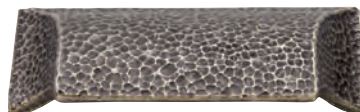

**P3064-WOA**  
96MM C/C

## CHARLESTON BLACKSMITH

AVAILABLE FINISHES



RI

BI



**P1311-RI**  
Knob  
1 1/2" Dia.



**P1312-RI**  
Knob  
1 1/4" Dia.



**P1321-RI**  
3" C/C  
3 3/4" L



**PA1322-RI**  
3" C/C, 4 3/8" L



**PA1323-RI**  
3" C/C, 4 1/2" L

ITEM	1+	25+	100+
PA1322	\$5.28	\$4.80	\$4.00
PA1323	\$4.75	\$4.33	\$3.60
PA1311	\$3.42	\$2.96	\$2.46
PA1312	\$2.77	\$2.52	\$2.10
PA1321	\$4.29	\$3.90	\$3.25

## MANCHESTER

AVAILABLE FINISHES



RI

VP



**P2014-RI**  
2 1/8" L X 1 1/2" W



**P2023-RI**  
96MM C/C  
4 1/8" L

ITEM	1+	25+	100+
P2014	\$5.02	\$4.58	\$3.81
P2023	\$5.28	\$4.80	\$4.00

## RALEIGH

AVAILABLE FINISHES



PN

SN

WOA

OBH



**P3111-WOA**  
5" C/C, 5 3/4" L

ITEM	1+	25+	100+
P3111	\$6.28	\$5.71	\$4.76

## REFINED RUSTIC

AVAILABLE FINISHES



RI

BL



**P3002-BL**  
1 1/4" Dia.



**P3003-BL**  
1 1/2" Dia.



**P3001-BL**  
3" C/C, 4 3/4" L



**P3000-BL**  
96MM C/C, 5 1/2" L



**P3004-BL**  
3" & 96MM C/C, 5 1/2" L

ITEM	1+	25+	100+
P3000	\$5.89	\$5.36	\$4.46
P3001	\$4.75	\$4.33	\$3.60
P3002	\$4.96	\$4.51	\$3.75
P3003	\$5.15	\$4.68	\$3.90
P3004	\$6.47	\$5.89	\$4.90



## BRIDGES

### AVAILABLE FINISHES



CH SN BGB OBH

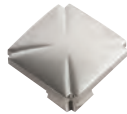

**P3230-SN**  
1 5/32" SQ  
1" PROJ



**P3231-SN**  
3" C/C, 3 5/8" L



**P3232-SN**  
96MM C/C, 4 7/16" L

ITEM	1+	25+	100+
<b>P3230</b>	\$4.30	\$3.90	\$3.26
<b>P3231</b>	\$4.57	\$4.15	\$3.46
<b>P3232</b>	\$5.81	\$5.29	\$4.41

## RICHELIEU - SOLID BRASS

### AVAILABLE FINISHES

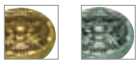

07 15A



**F106-07**  
Round Knob  
1 1/4" Dia.

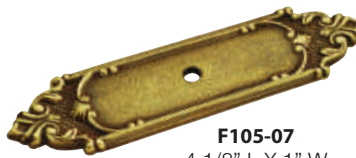

**F105-07**  
4 1/8" LX 1" W

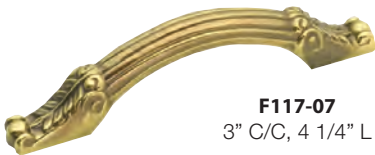

**F117-07**  
3" C/C, 4 1/4" L



**F110-07**  
3" C/C, 7 1/4" L

ITEM	1+	25+	100+
<b>F105-07</b>	\$12.54	\$11.41	\$9.51
<b>F106-07</b>	\$12.99	\$11.81	\$9.84
<b>F110-07</b>	\$13.80	\$12.54	\$10.46
<b>F117-07</b>	\$16.21	\$14.75	\$12.28

## MANOR HOUSE

### AVAILABLE FINISHES



DAC LP ST



**MOCK KEY**  
**P321-ST**  
1" PROJ



**P329-ST**  
3" C/C



**P8049-ST**  
3" C/C, 4" L



**BACKPLATE**  
**P326-ST**  
5 1/2" LX 1" W

ITEM	1+	25+	100+
<b>P321</b>	\$2.58	\$2.34	\$1.96
<b>P326</b>	\$3.96	\$3.61	\$3.01
<b>P329</b>	\$6.86	\$6.24	\$5.20
<b>P8049</b>	\$6.28	\$5.71	\$4.76

NOTE: P321, P326, and P329 are not available in DAC Finish.

## KINGSTON

### AVAILABLE FINISH



OEP



**M682**  
1 1/4" SQ

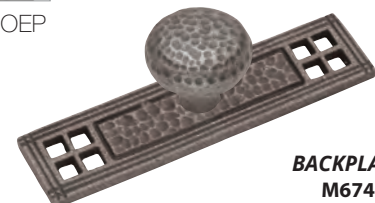

**BACKPLATE**  
**M674**  
4 1/4" LX 1" W

**KNOB**  
**M671**  
1 1/4" Dia.



**BACKPLATE**  
**M679**  
6 1/2" LX 1" W  
3" C/C

**KNOB**  
**M677**  
3" C/C

ITEM	1+	25+
<b>M671</b>	\$11.16	\$10.14
<b>M674</b>	\$12.59	\$11.45
<b>M677</b>	\$16.35	\$14.87
<b>M679</b>	\$14.12	\$12.84
<b>M682</b>	\$11.16	\$10.14

### CRAFTSMAN

AVAILABLE FINISHES



CH WOA BI OBH

ITEM	1+	25+
<b>P2175</b>	\$10.11	\$9.19

**P2175-BI**  
HOOK  
1 3/8" C/C  
5 1/16" L X 2" W



### BUNGALOW

AVAILABLE FINISHES



SN WOA OBH 10B PN

ITEM	1+	25+
<b>P2155</b>	\$10.43	\$9.48

**P2155-WOA**  
HOOK  
1 1/2" C/C  
5" L X 2" W



### FORGE SIGNATURE HOOKS

AVAILABLE FINISHES



SN CH BGB BI

ITEM	1+	25+	100+
<b>S077190</b>	\$5.53	\$5.03	\$4.19

**S077190-BGB**  
HOOK  
1 1/2" C/C  
2 3/4" L X 2" W



### PIPELINE SIGNATURE HOOKS

AVAILABLE FINISHES



BNV VB

ITEM	1+	25+	100+
<b>S077188</b>	\$5.02	\$4.56	\$3.80

**S077190-BGB**  
HOOK  
1 1/2" C/C  
2 1/2" L X 1 1/8" W



### SKYLIGHT SIGNATURE HOOKS

AVAILABLE FINISHES



14 SS BGR VR

ITEM	1+	25+	100+
<b>S077192</b>	\$5.02	\$4.56	\$3.80

**S077192-14**  
HOOK  
1" C/C  
4 7/8" L X 1 1/22" W



JEFFREY ALEXANDER<sup>®</sup>  
*by Hardware Resources*

# JEFFREY ALEXANDER®

by Hardware Resources

## Aberdeen

AVAILABLE FINISHES

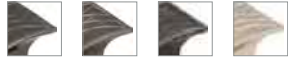

BNB BNBDL DBAC SN



**535-BNB**  
Square Knob  
1 1/4" Dia.



**535L-BNB**  
Oblong Knob  
1 1/2" Dia.



**535-96-BNB**  
3 3/4" CC  
5" Long



**536-96-BNB**  
3 3/4" CC cup pull  
5" Long



**535-128-BNB**  
5" CC  
6 1/4" Long



**536-128-BNB**  
5" CC cup pull  
6 1/4" Long



**535-160-BNB**  
6 1/4" CC  
5 5/8" Long

Item	1+	25+	100+
<b>535</b>	\$3.63	\$3.27	\$3.03
<b>535L</b>	\$3.63	\$3.27	\$3.03
<b>535-96</b>	\$6.44	\$5.79	\$5.36
<b>536-96</b>	\$7.25	\$6.52	\$6.04
<b>535-128</b>	\$8.93	\$8.03	\$7.44
<b>536-128</b>	\$10.56	\$9.50	\$8.80
<b>535-160</b>	\$11.00	\$9.90	\$9.16

## Alvar

AVAILABLE FINISHES



PC BNBDL DBAC SN NI SBZ



**264-3-SBZ**  
3" CC  
3 11/16" Long



**264-96-SBZ**  
3 3/4" CC  
5 7/16" Long



**264-128-SBZ**  
5" CC  
5 3/4" Long



**264-160-SBZ**  
6 1/4" CC  
7" Long



**264-192-SBZ**  
7 9/16" CC  
8 1/4" Long

Item	1+	25+	100+
<b>264-3</b>	\$2.58	\$2.32	\$2.15
<b>264-96</b>	\$2.90	\$2.61	\$2.41
<b>264-128</b>	\$3.36	\$3.02	\$2.80
<b>264-160</b>	\$4.16	\$3.74	\$3.46
<b>264-192</b>	\$4.98	\$4.48	\$4.15

## Amsden

AVAILABLE FINISHES



DP DMAC DBAC SN NI



**613-DMAC**  
Small Knob  
1 7/16" Dia.



**613L-DMAC**  
Large Knob  
1 5/8" Dia.



**613-96-DMAC**  
3 3/4" CC  
4 3/8" Long



**613-128-DMAC**  
5" CC  
5 5/8" Long



**613-160-DMAC**  
6 1/4" CC  
6 7/8" Long

Item	1+	25+	100+
<b>613</b>	\$2.61	\$2.35	\$2.18
<b>613L</b>	\$3.62	\$3.25	\$3.01
<b>613-96</b>	\$3.14	\$2.82	\$2.61
<b>613-128</b>	\$5.19	\$4x.67	\$4.33
<b>613-160</b>	\$6.71	\$6.03	\$5.59

JEFFREY ALEXANDER

# JEFFREY ALEXANDER®

by Hardware Resources

## Annadale

AVAILABLE FINISHES

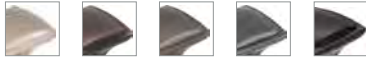

SN DBAC BNBDL DACM MB



**435-DACM**  
Square knob  
1 1/4" Dia.



**435L-DACM**  
Oblong knob  
1 1/2" Dia.

Item	1+	25+	100+
<b>435</b>	\$3.48	\$3.13	\$2.90
<b>435L</b>	\$3.48	\$3.13	\$2.90
<b>435-96</b>	\$5.19	\$4.67	\$4.33
<b>436-96</b>	\$6.44	\$5.79	\$5.36
<b>435-128</b>	\$8.10	\$7.29	\$6.75
<b>436-128</b>	\$9.77	\$8.79	\$8.14
<b>435-160</b>	\$10.16	\$9.14	\$8.46



**435-96-DACM**  
3 3/4" CC  
5" Long



**435-128-DACM**  
5" CC  
6 1/4" Long



**435-160-DACM**  
6 1/4" CC  
7 5/8" Long



**436-96-DACM**  
3 3/4" CC cup pull  
5" Long



**436-128-DACM**  
5" CC cup pull  
6 1/4" Long

## Anwick

AVAILABLE FINISHES



BNBDL DBAC NI SN



**867-SN**  
Oblong Knob  
1 3/8" Dia.



**867L-SN**  
Square Knob  
1 1/8" Dia.

Item	1+	25+	100+
<b>867</b>	\$3.20	\$2.88	\$2.66
<b>867L</b>	\$3.30	\$2.97	\$2.75
<b>867-3</b>	\$3.93	\$3.54	\$3.28
<b>867-96</b>	\$4.98	\$4.48	\$4.15
<b>867-128</b>	\$6.93	\$6.24	\$5.78
<b>867-160</b>	\$7.83	\$7.05	\$6.53
<b>867-228</b>	\$11.19	\$10.07	\$9.33
<b>867-320</b>	\$19.35	\$17.42	\$16.13



**867-3-SN**  
3" CC  
4 5/16" Long



**867-96-SN**  
3 3/4" CC  
5 1/8" Long



**867-128-SN**  
5" CC  
6 3/8" Long



**867-160-SN**  
6 1/4" CC  
7 5/8" Long



**867-228-SN**  
9" CC  
10 5/16" Long



**867-320-SN**  
12 5/8" CC  
13 15/16" Long

JEFFREY ALEXANDER



## Ashton

AVAILABLE FINISHES



ABM-D BNM DL DBAC



**3171-ABM-D**  
Small Knob  
1 5/16" Dia.



**3174-ABM-D**  
Large Knob  
1 5/8" Dia.



**3172-ABM-D**  
3 3/4" CC  
4 15/16" Long



**3173-ABM-D**  
3 3/4" CC cup pull  
5 1/8" Long

Item	1+	25+	100+
<b>3171</b>	\$1.40	\$1.26	\$1.16
<b>3174</b>	\$1.61	\$1.44	\$1.34
<b>3172</b>	\$2.19	\$1.97	\$1.83
<b>3173</b>	\$1.40	\$1.26	\$1.16

## Belcastel 1

AVAILABLE FINISHES

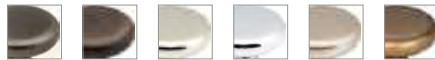

BNBDL DBAC NI PC SN SBZ



ABM-D DACM DMAC SIM-D



**MO6303-BNBDL**  
Knob  
1 3/8" Dia.



**MO6373-BNBDL**  
3 3/4" CC  
4 5/8" Long



**MO6373-128-BNBDL**  
5" CC  
5 7/8" Long



**MO6373-160-BNBDL**  
6 1/4" CC  
7 1/8" Long



**MO6373-12-BNBDL**  
12" CC appliance pull  
13 1/4" Long

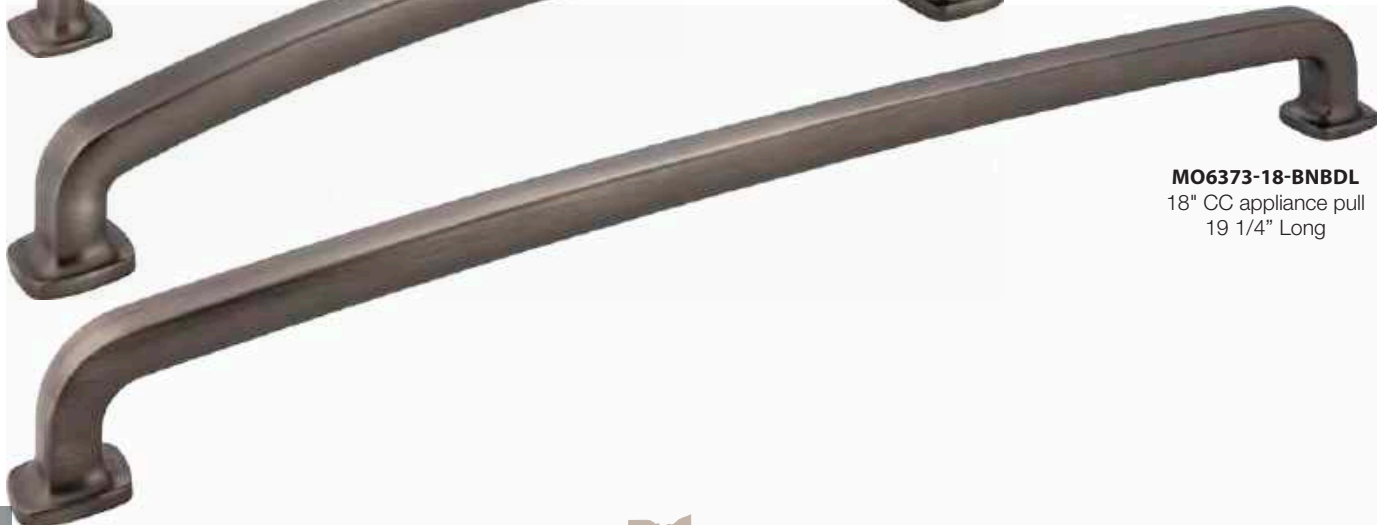

**MO6373-18-BNBDL**  
18" CC appliance pull  
19 1/4" Long

Item	1+	25+	100+
<b>MO6303</b>	\$2.57	\$2.31	\$2.14
<b>MO6373</b>	\$3.21	\$2.89	\$2.68
<b>MO6373-128</b>	\$4.20	\$3.78	\$3.50
<b>MO6373-160</b>	\$5.06	\$4.55	\$4.21
<b>MO6373-12</b>	\$45.57	\$41.01	\$37.98
<b>MO6373-18</b>	\$57.21	\$51.49	\$47.68

# JEFFREY ALEXANDER®

by Hardware Resources

## Bella

AVAILABLE FINISHES



ABSB BNBDL DBAC NI SN



**818-ABSB**  
Round Knob  
1 3/8" Dia.



**818L-ABSB**  
T Knob  
2 1/4" Dia.

Item	1+	25+	100+
<b>818</b>	\$4.10	\$3.69	\$3.41
<b>818L</b>	\$5.39	\$4.85	\$4.49
<b>818-96</b>	\$6.36	\$5.72	\$5.30
<b>818-128</b>	\$7.32	\$6.59	\$6.10
<b>818-160</b>	\$9.35	\$8.41	\$7.79
<b>818-12</b>	\$48.95	\$44.05	\$40.79



**818-96-ABSB**  
3 3/4" CC  
4 3/8" Long



**818-128-ABSB**  
5" CC  
5 11/16" Long



**818-160-ABSB**  
6 1/4" CC  
6 15/16" Long



**818-12-ABSB**  
12" CC appliance pull  
13 1/8" Long

## Bienville

AVAILABLE FINISHES



ABSB BNBDL DBAC



**959-BNBDL**  
Knob  
1 5/16" Dia.



**959-96-BNBDL**  
3 3/4" CC  
5 13/16" Long

Item	1+	25+	100+
<b>959</b>	\$3.39	\$3.05	\$2.83
<b>959-96</b>	\$4.82	\$4.33	\$4.01

## Bordeaux

AVAILABLE FINISHES



AB BLK BNBDL DACM DBAC



NI ORB PC SIM SN



**3990-ORB**  
Egg Knob  
1 3/16" Dia.



**8236-ORB**  
3 3/4" CC  
5" Long

Item	1+	25+	100+
<b>3990</b>	\$2.37	\$2.13	\$1.98
<b>8236</b>	\$2.87	\$2.58	\$2.39

JEFFREY ALEXANDER

# JEFFREY ALEXANDER®

by Hardware Resources

## Boswell – NEW!

AVAILABLE FINISHES



MB BNBDL DBAC PC SN



**177-96**  
96MM CC  
4 1/4" Long



**177-128**  
128MM CC  
5 9/16" Long



**177-160**  
160MM CC  
6 13/16" Long



**177-192**  
192MM CC  
8 1/16" Long



**177-224**  
224MM CC  
9 5/16" Long

Item	1+	25+	100+
<b>177-96</b>	\$2.82	\$2.54	\$2.35
<b>177-128</b>	\$3.72	\$3.35	\$3.10
<b>177-160</b>	\$4.65	\$4.19	\$3.88
<b>177-192</b>	\$5.60	\$5.04	\$4.66
<b>177-224</b>	\$6.54	\$5.89	\$5.45

JEFFREY ALEXANDER

## Brighton

AVAILABLE FINISHES

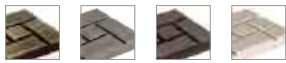

ABSB BNBDL DBAC SN



**874-DBAC**  
Knob  
1 7/16" Dia.



**874-96-DBAC**  
3 3/4" CC  
6 3/16" Long



**874-128-DBAC**  
5" CC  
7 5/8" Long



**874-160-DBAC**  
6 1/4" CC  
9 1/8" Long

Item	1+	25+	100+
<b>874</b>	\$2.73	\$2.46	\$2.28
<b>874-96</b>	\$5.97	\$5.37	\$4.98
<b>874-128</b>	\$8.15	\$7.33	\$6.79
<b>874-160</b>	\$10.17	\$9.15	\$8.48



## Bremen 1

AVAILABLE FINISHES



BNBDL DBAC NI PC SN SBZ



ABM-D ABSB DACM DMAC SIM



**117-DACM**  
Knob  
1 1/4" Dia.

Item	1+	25+	100+
<b>117</b>	\$1.92	\$1.73	\$1.60
<b>527</b>	\$3.86	\$3.47	\$3.21
<b>527-128</b>	\$4.49	\$4.04	\$3.74
<b>527-160</b>	\$5.76	\$5.18	\$4.80
<b>527-12</b>	\$45.57	\$41.01	\$37.98



**527-DACM**  
3 3/4" CC  
4 5/8" Long



**527-128-DACM**  
5" CC  
5 7/8" Long



**527-160-DACM**  
6 1/4" CC  
7 1/8" Long



**527-12-DACM**  
12" CC appliance pull  
13 1/16" Long



**535L-BNBDL**  
Aberdeen

**535-128-BNBDL**  
Aberdeen

## Bremen 2

AVAILABLE FINISHES



ABSB DACM DBAC DMAC NI SN



**127-NI**  
Knob (barrel)  
1 3/16" Dia.



**137-NI**  
Knob (stacked)  
1 1/4" Dia.

Item	1+	25+	100+
<b>127</b>	\$2.57	\$2.31	\$2.14
<b>137</b>	\$1.92	\$1.73	\$1.60
<b>537</b>	\$3.21	\$2.89	\$2.68
<b>537-128</b>	\$3.86	\$3.47	\$3.21
<b>537-160</b>	\$4.49	\$4.04	\$3.74
<b>537-12</b>	\$45.57	\$41.01	\$37.98



**537-NI**  
3 3/4" CC  
4 3/16" Long



**537-128-NI**  
5" CC  
5 7/16" Long



**537-160-NI**  
6 1/4" CC  
6 9/16" Long



**537-12-NI**  
12" CC appliance pull  
12 11/16" Long

## Cairo

AVAILABLE FINISHES



PC BNBDL DBAC SN

**595-SN**  
Knob  
1 1/4" Dia.



**595-96-SN**  
3 3/4" CC  
4 13/16" Long



**595-128-SN**  
5" CC  
6 1/16" Long

Item	1+	25+	100+
<b>595</b>	\$1.95	\$1.76	\$1.63
<b>595-96</b>	\$2.64	\$2.38	\$2.20
<b>595-128</b>	\$3.18	\$2.86	\$2.65

# JEFFREY ALEXANDER®

by Hardware Resources

## Callie

### AVAILABLE FINISHES



BNBDL DBAC NI PC SN



**839-3-PC**  
3" CC  
4 3/16" Long



**839-96-PC**  
3 3/4" CC  
4 15/16" Long



**839-128-PC**  
5" CC  
6 1/4" Long



**839-160-PC**  
60 1/4" CC  
7 1/2" Long

Item	1+	25+	100+
<b>839-3</b>	\$3.06	\$2.75	\$2.55
<b>839-96</b>	\$3.95	\$3.55	\$3.29
<b>839-128</b>	\$4.76	\$4.28	\$3.96
<b>839-160</b>	\$5.69	\$5.12	\$4.74

## Chesapeake

### AVAILABLE FINISHES



ABSB BNBDL BNDL DACM DBAC SIM SN



**737-96-BNBDL**  
3 3/4" CC  
4 1/4" Long



**737-128-BNBDL**  
5" CC  
5 1/2" Long



**737-160-BNBDL**  
6 1/4" CC  
6 3/4" Long



**737-12-BNBDL**  
12" CC appliance pull  
12 5/16" Long



**915-BNBDL**  
Knob  
1 5/16" Dia.



**Z110-BNBDL**  
Knob  
1 3/16" Dia.

Item	1+	25+	100+
<b>915</b>	\$2.24	\$2.01	\$1.86
<b>Z110</b>	\$1.41	\$1.27	\$1.18
<b>737-96</b>	\$3.05	\$2.74	\$2.54
<b>737-128</b>	\$3.81	\$3.43	\$3.18
<b>737-160</b>	\$4.64	\$4.17	\$3.86
<b>737-12</b>	\$45.57	\$41.01	\$37.98

NOTE: BNDL Finish is only available on Z110.

JEFFREY ALEXANDER

## Cordova

### AVAILABLE FINISHES

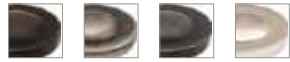

ABSB BNDL DBAC SN



**0251-SN**  
Knob  
1 3/8" Dia.



**Z110-SN**  
Knob  
1 3/16" Dia.



**Z111-SN**  
Knob  
1 1/4" Dia.

Item	1+	25+	100+
<b>0251</b>	\$1.88	\$1.69	\$1.56
<b>Z110</b>	\$1.41	\$1.27	\$1.18
<b>Z111</b>	\$1.83	\$1.65	\$1.53
<b>Z281</b>	\$2.54	\$2.28	\$2.11
<b>Z280</b>	\$3.09	\$2.78	\$2.58
<b>Z281-128</b>	\$4.43	\$3.98	\$3.69
<b>Z281-160</b>	\$5.69	\$5.12	\$4.74
<b>Z281-12</b>	\$45.57	\$41.01	\$37.98
<b>Z281-18</b>	\$57.21	\$51.49	\$47.68

NOTE: 0251 is also available in BNDL Finish. Z110 is also available in BNDL, DACM or SIN Finishes. 0251 is not available in BNDL.



**Z281-SN**  
3" CC  
3 3/8" Long



**Z280-SN**  
3 3/4" CC  
4 3/16" Long



**Z281-128-SN**  
5" CC  
5 7/16" Long



**Z281-160-SN**  
6 1/4" CC  
6 11/16" Long



**Z281-12-SN**  
12" CC appliance pull  
12 3/4" Long



**Z281-18-SN**  
18" CC appliance pull  
18 3/4" Long

## Delgado

AVAILABLE FINISHES



BNBDL ABSB DBAC NI SN



**519-NI**  
Knob  
1 9/16" Dia.

Item	1+	25+	100+
<b>519</b>	\$3.56	\$3.20	\$2.96
<b>519-96</b>	\$6.36	\$5.72	\$5.30
<b>519-128</b>	\$10.61	\$9.54	\$8.84
<b>519-160</b>	\$13.38	\$12.04	\$11.15
<b>519-12</b>	\$48.95	\$44.05	\$40.79
<b>519-18</b>	\$60.42	\$54.38	\$50.35



**519-96-NI**  
3 3/4" CC  
4 1/4" Long



**519-128-NI**  
5" CC  
5 9/16" Long



**519-160-NI**  
6 1/4" CC  
6 13/16" Long



**519-12-NI**  
12" CC appliance pull  
12 1/2" Long



**519-18-NI**  
18" CC appliance pull  
18 1/2" Long



**585-96-DP**  
Delmar

JEFFREY ALEXANDER

# JEFFREY ALEXANDER®

by Hardware Resources

## Delmar

AVAILABLE FINISHES

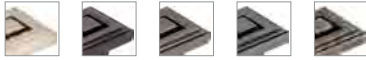

SN DBAC BNBDL DACM DP



**585-96-DP**  
3 3/4" CC  
4 1/2" Long

**585-DP**  
Small knob  
1" Dia.

**585L-DP**  
Large knob  
1 1/4" Dia.

**585-128-DP**  
5" CC  
5 13/16" Long

**585-160-DP**  
6 1/4" CC  
7 1/16" Long

**585-12-DP**  
12" appliance pull  
13 1/4" Long

Item	1+	25+	100+
<b>585</b>	\$3.60	\$3.24	\$3.00
<b>585L</b>	\$4.52	\$4.06	\$3.76
<b>585-96</b>	\$5.70	\$5.13	\$4.75
<b>585-128</b>	\$9.09	\$8.18	\$7.58
<b>585-160</b>	\$11.70	\$10.53	\$9.75
<b>585-12</b>	\$53.67	\$48.30	\$44.73

## Durham

AVAILABLE FINISHES



PC ABSB BNBDL DACM SN ORB DBAC



**Z290-3-DBAC**  
3" CC  
3 3/8" Long

**Z290-96-DBAC**  
3 3/4" CC  
4 1/4" Long

**Z290-128-DBAC**  
5" CC  
5 1/2" Long

**Z290-160-DBAC**  
6 1/4" CC  
6 3/4" Long

**Z290-12-DBAC**  
12" CC  
13" Long

**3980-DBAC**  
Knob  
1 1/4" Dia.

Item	1+	25+	100+
<b>3980</b>	\$2.39	\$2.15	\$1.99
<b>Z290-3</b>	\$1.89	\$1.70	\$1.58
<b>Z290-96</b>	\$2.37	\$2.13	\$1.98
<b>Z290-128</b>	\$5.06	\$4.55	\$4.21
<b>Z290-160</b>	\$5.76	\$5.18	\$4.80
<b>Z290-12</b>	\$45.57	\$41.01	\$37.98

JEFFREY ALEXANDER



# JEFFREY ALEXANDER®

by Hardware Resources

## Duval

### AVAILABLE FINISHES



BNBDL DACM DBAC NI SN



**343-BNBDL**  
Knob  
1 1/4" Dia.

Item	1+	25+	100+
<b>343</b>	\$4.20	\$3.78	\$3.50
<b>343-96</b>	\$5.79	\$5.21	\$4.83
<b>343-128</b>	\$7.91	\$7.11	\$6.59
<b>343-160</b>	\$8.78	\$7.90	\$7.31
<b>343-12</b>	\$57.21	\$51.49	\$47.68



**343-96-BNBDL**  
3 3/4" CC  
4 1/2" Long



**343-128-BNBDL**  
5" CC  
5 13/16" Long



**343-160-BNBDL**  
6 1/4" CC  
7 1/16" Long



**343-12-BNBDL**  
12" CC appliance pull  
13 1/8" Long

## Elara – NEW!

### AVAILABLE FINISHES



BNBDL MB DBAC PC SN SBZ



**484-SBZ**  
Knob  
1 1/4" Dia.

Item	1+	25+	100+
<b>484</b>	\$2.04	\$1.84	\$1.70
<b>484-32</b>	\$2.52	\$2.27	\$2.10
<b>484-396</b>	\$4.08	\$3.67	\$3.40
<b>484-128160</b>	\$5.64	\$5.08	\$4.70
<b>484-192224</b>	\$7.89	\$7.10	\$6.58
<b>484-305</b>	\$20.12	\$18.10	\$16.76



**484-32-SBZ**  
32MM CC  
2 1/16" Long



**484-396-SBZ**  
3" or 96MM CC  
4 9/16" Long



**484-128160-SBZ**  
128MM or 160MM CC  
7 1/8" Long



**484-192224-SBZ**  
192MM or 224MM CC  
9 5/8" Long



**484-305-SBZ**  
305MM CC  
12 13/16" Long

JEFFREY ALEXANDER

# JEFFREY ALEXANDER®

by Hardware Resources

## Ella

AVAILABLE FINISHES

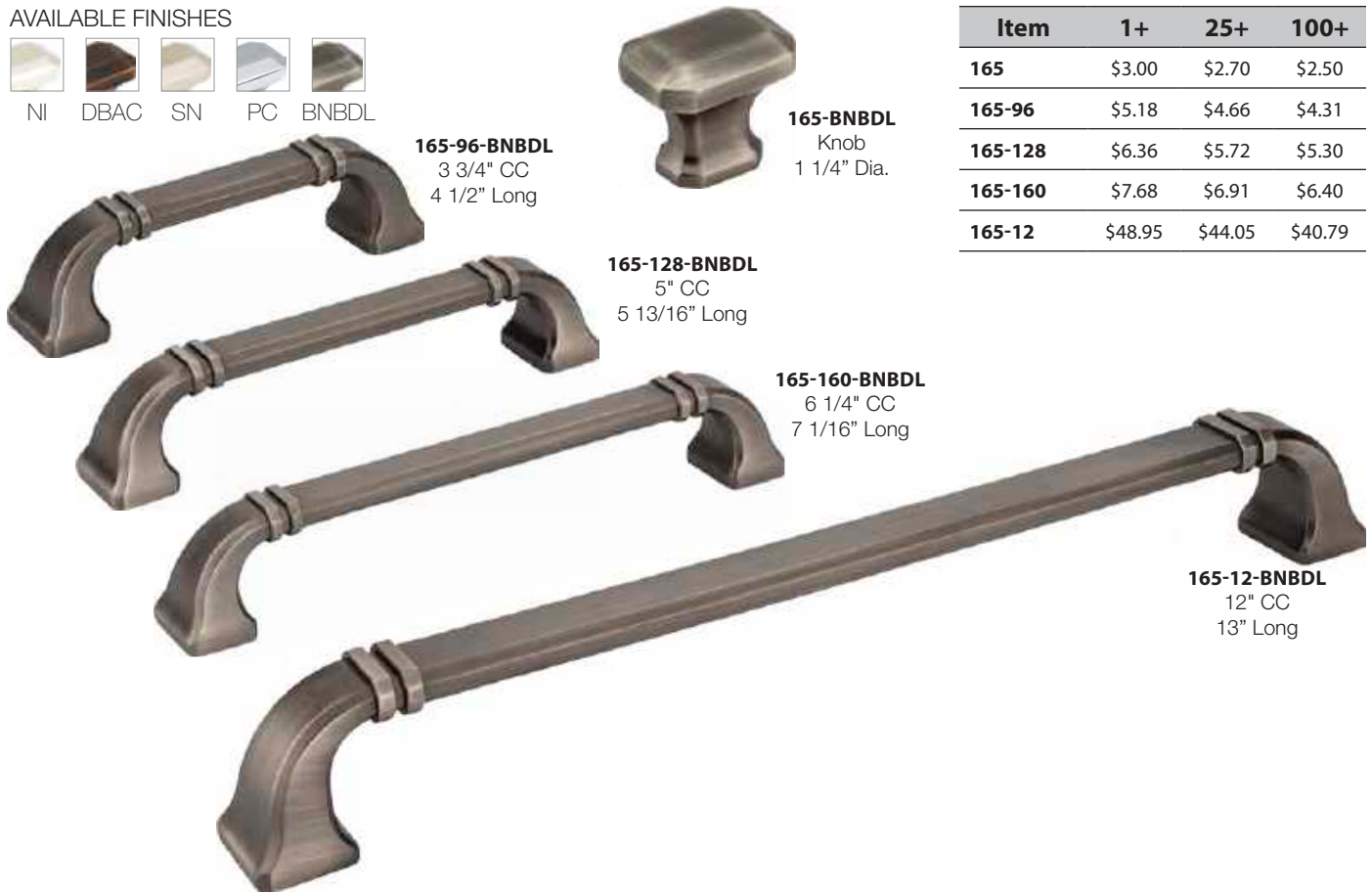

Item	1+	25+	100+
165	\$3.00	\$2.70	\$2.50
165-96	\$5.18	\$4.66	\$4.31
165-128	\$6.36	\$5.72	\$5.30
165-160	\$7.68	\$6.91	\$6.40
165-12	\$48.95	\$44.05	\$40.79

**165-96-BNBDL**  
3 3/4" CC  
4 1/2" Long

**165-BNBDL**  
Knob  
1 1/4" Dia.

**165-128-BNBDL**  
5" CC  
5 13/16" Long

**165-160-BNBDL**  
6 1/4" CC  
7 1/16" Long

**165-12-BNBDL**  
12" CC  
13" Long

## Encada

AVAILABLE FINISHES



Item	1+	25+	100+
123	\$4.14	\$3.73	\$3.45
123-96	\$4.47	\$4.02	\$3.73
125	\$4.14	\$3.73	\$3.45
125-96	\$4.47	\$4.02	\$3.73

**123-AEM**  
Knob  
1 3/16" Dia.

**125-AEM**  
Knob  
1 3/16" Dia.

**123-96-AEM**  
3 3/4" CC  
4 13/16" Long

**125-96-AEM**  
3 3/4" CC  
4 13/16" Long

## Evangeline

AVAILABLE FINISHES



Item	1+	25+	100+
925	\$3.39	\$3.05	\$2.83
925-96	\$4.79	\$4.31	\$3.99

**925-DBAC**  
Knob  
1 3/4" Dia.

**925-96-DBAC**  
3 3/4" CC  
6 1/2" Long



# JEFFREY ALEXANDER®

by Hardware Resources

## Glenmore

AVAILABLE FINISHES

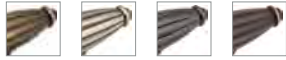

ABSB BNMDL DACM DBAC



**618-BNMDL**  
Small Knob  
2 5/8" Dia.



**618L-BNMDL**  
Large Knob  
2 15/16" Dia.

Item	1+	25+	100+
<b>618</b>	\$2.24	\$2.01	\$1.86
<b>618L</b>	\$3.81	\$3.43	\$3.18
<b>718</b>	\$4.43	\$3.98	\$3.69
<b>718-128</b>	\$5.69	\$5.12	\$4.74
<b>Z718-12</b>	\$45.57	\$41.01	\$37.98



**718-BNMDL**  
5" CC  
5 3/4" Long



**718-128-BNMDL**  
5" CC bail pull  
5 15/16" Long



**Z718-12-BNMDL**  
5" CC appliance pull  
13 5/16" Long

## Harlow



**G110-DBAC**  
Small egg  
1 1/4" Dia.



**G120-PC**  
Small button  
1 7/16" Dia.



**G130-DBAC**  
Small sphere  
1 1/16" Dia.



**G110L-BNBDL**  
Large egg  
1 5/8" Dia.



**G120L-SN**  
Large button  
1 3/4" Dia.



**G130L-BNBDL**  
Large sphere  
1 3/8" Dia.



**G140-BNBDL**  
Small square  
1" Dia.



**G140L-SN**  
Large square  
1 3/8" Dia.



**G150-DBAC**  
Small faceted  
1" Dia.



**G150L-PC**  
Large faceted  
1 1/4" Dia.

Item	1+	25+	100+
<b>G110</b>	\$5.57	\$5.01	\$4.64
<b>G110L</b>	\$8.69	\$7.82	\$7.24
<b>G120</b>	\$5.57	\$5.01	\$4.64
<b>G120L</b>	\$8.69	\$7.82	\$7.24
<b>G130</b>	\$5.15	\$4.63	\$4.29
<b>G130L</b>	\$5.96	\$5.36	\$4.96
<b>G140</b>	\$5.57	\$5.01	\$4.64
<b>G140L</b>	\$8.69	\$7.82	\$7.24
<b>G150</b>	\$4.77	\$4.29	\$3.98
<b>G150L</b>	\$5.96	\$5.36	\$4.96

JEFFREY ALEXANDER



# JEFFREY ALEXANDER®

by Hardware Resources

## Hayworth

AVAILABLE FINISHES



NI PC SN



**885-PC**  
Knob  
1 1/8" Dia.



**885L-PC**  
T Knob  
2" Dia.



**885-96-PC**  
3 3/4" CC  
4 3/4" Long



**885-128-PC**  
5" CC  
6" Long



**885-160-PC**  
6 1/4" CC  
7 1/4" Long



**885-192-PC**  
7 9/16" CC  
8 1/2" Long



**885-224-PC**  
8 13/16" CC  
9 3/4" Long



**885-305-PC**  
12" CC appliance pull  
4 3/4" Long

Item	1+	25+	100+
<b>885</b>	\$2.78	\$2.50	\$2.31
<b>885L</b>	\$3.27	\$2.94	\$2.73
<b>885-96</b>	\$4.98	\$4.48	\$4.15
<b>885-128</b>	\$5.78	\$5.20	\$4.81
<b>885-160</b>	\$6.72	\$6.05	\$5.60
<b>885-192</b>	\$7.76	\$6.98	\$6.46
<b>885-224</b>	\$8.78	\$7.90	\$7.31
<b>885-305</b>	\$20.93	\$18.83	\$17.44

JEFFREY ALEXANDER

## Hudson

AVAILABLE FINISHES

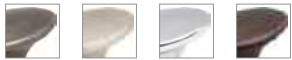

BNBDL SN PC DBAC



**650-DBAC**  
Knob  
1 7/8" Dia.



**650-96-DBAC**  
3 3/4" CC  
4 3/8" Long



**650-128-DBAC**  
3 3/4" CC  
5 5/8" Long



**650-160-DBAC**  
6 1/4" CC  
6 15/16" Long



**650-12-DBAC**  
12" CC appliance pull  
13" Long

Item	1+	25+	100+
<b>650</b>	\$2.52	\$2.27	\$2.10
<b>650-96</b>	\$3.14	\$2.82	\$2.61
<b>650-128</b>	\$3.81	\$3.43	\$3.18
<b>650-160</b>	\$4.98	\$4.48	\$4.15
<b>650-12</b>	\$45.57	\$41.01	\$37.98



## Katharine

AVAILABLE FINISHES

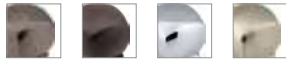

BNBDL DBAC PC SN



**188-SN**  
Small Knob  
7/8" Dia.



**188L-SN**  
Large Knob  
1" Dia.

Item	1+	25+	100+
<b>188</b>	\$3.21	\$2.89	\$2.68
<b>188L</b>	\$3.56	\$3.20	\$2.96
<b>188-96</b>	\$4.94	\$4.44	\$4.11
<b>188-128</b>	\$6.54	\$5.89	\$5.45
<b>188-160</b>	\$8.03	\$7.22	\$6.69



**188-96-SN**  
3 3/4" CC  
4 3/8" Long



**188-128-SN**  
5" CC  
5 11/16" Long



**188-160-SN**  
6 1/4" CC  
6 15/16" Long

## Key Grande

AVAILABLE FINISHES



SN BG



**596-SN**  
3 3/4" CC  
5 3/8" Long



**5128-SN**  
5" CC  
6 5/8" Long



**5192-SN**  
7 9/16" CC  
9 1/8" Long



**5224-SN**  
8 13/16" CC  
10 3/8" Long



**5319-SN**  
12 5/8" CC  
14 1/8" Long

**5480-SN**  
18 7/8" CC  
20 1/2" Long

**5673-SN**  
26 1/2" CC  
28 1/16" Long

**5900-SN**  
35 7/16" CC  
37" Long

Item	1+	25+	100+
<b>596</b>	\$5.69	\$5.12	\$4.74
<b>5128</b>	\$6.33	\$5.70	\$5.28
<b>5192</b>	\$7.65	\$6.89	\$6.38
<b>5224</b>	\$8.15	\$7.33	\$6.79
<b>5319</b>	\$10.10	\$9.09	\$8.41
<b>5480</b>	\$11.93	\$10.73	\$9.94
<b>5673</b>	\$15.89	\$14.30	\$13.24
<b>5900</b>	\$20.93	\$18.83	\$17.44

JEFFREY ALEXANDER



## Key West & Key Largo

### AVAILABLE FINISHES



ORB SN MB BG SBZ



**48-SN**  
T Knob  
1 7/8" Dia.



**146-SN**  
3 3/4" CC  
5 3/4" Long



**152-SN**  
3 3/4" CC  
6" Long



**178-SN**  
5" CC  
7" Long



**242-SN**  
7 9/16" CC  
9 1/2" Long



**274-SN**  
8 13/16" CC  
10 3/4" Long



**370-SN**  
12 5/8" CC  
14 9/16" Long

**530-SN**  
18 7/8" CC  
20 7/8" Long

**722-SN**  
26 1/2" CC  
28 7/16" Long

**950-SN**  
35 1/2" CC  
37 3/8" Long

Item	1+	25+	100+
<b>48</b>	\$1.95	\$1.76	\$1.63
<b>146</b>	\$3.90	\$3.51	\$3.25
<b>152</b>	\$4.11	\$3.70	\$3.43
<b>178</b>	\$4.56	\$4.10	\$3.80
<b>242</b>	\$5.19	\$4.67	\$4.33
<b>274</b>	\$5.64	\$5.08	\$4.70
<b>370</b>	\$6.42	\$5.78	\$5.35
<b>530</b>	\$8.69	\$7.82	\$7.24
<b>722</b>	\$13.95	\$12.56	\$11.63
<b>950</b>	\$16.32	\$14.69	\$13.60

NOTE: 242, 274, 370, 530, 722 and 950 are not available in ORB Finish.

# JEFFREY ALEXANDER®

by Hardware Resources

## Lafayette

AVAILABLE FINISHES



ABSB BNBDL DBAC SN



**218-DBAC**  
Fleur-de-lis Knob  
1 3/8" Dia.



**317-DBAC**  
Circles Knob  
1 3/8" Dia.



**417-DBAC**  
Baroque Knob  
1 3/8" Dia.

Item	1+	25+	100+
<b>218</b>	\$4.10	\$3.69	\$3.41
<b>317</b>	\$3.72	\$3.35	\$3.10
<b>417</b>	\$3.90	\$3.51	\$3.25
<b>317-96</b>	\$5.39	\$4.85	\$4.49
<b>317-128</b>	\$5.99	\$5.39	\$4.99
<b>317-160</b>	\$7.05	\$6.35	\$5.88
<b>317-12</b>	\$52.65	\$47.39	\$43.88



**317-96-DBAC**  
3 3/4" CC  
4 3/8" Long



**317-128-DBAC**  
5" CC  
5 5/8" Long



**317-160-DBAC**  
6 1/4" CC  
6 7/8" Long



**317-12-DBAC**  
12" CC appliance pull  
12 15/16" Long

## Lenoir

AVAILABLE FINISHES

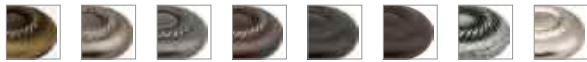

ABSB BNBDL DACM DBAC MB ORB SIM SN



**Z117-ABSB**  
Knob  
1 1/4" Dia.



**8237-ABSB**  
3 3/4" CC  
5" Long

Item	1+	25+	100+
<b>Z117</b>	\$1.89	\$1.70	\$1.58
<b>8237</b>	\$2.24	\$2.01	\$1.86

JEFFREY ALEXANDER



## Lexa

AVAILABLE FINISHES



BN BNBDL DBAC PC SN



**259-BN**  
Knob  
2" Dia.



**259-96-BN**  
3 3/4" CC  
4 3/16" Long



**259-128-BN**  
5" CC  
5 7/16" Long



**259-160-BN**  
6 1/4" CC  
6 11/16" Long



**259-192-BN**  
7 9/16" CC  
8" Long

Item	1+	25+	100+
<b>259</b>	\$3.35	\$3.01	\$2.79
<b>259-96</b>	\$5.70	\$5.13	\$4.75
<b>259-128</b>	\$6.78	\$6.10	\$5.65
<b>259-160</b>	\$7.58	\$6.82	\$6.31
<b>259-192</b>	\$8.93	\$8.03	\$7.44

## Leyton

AVAILABLE FINISHES



BNBDL DBAC SN PC NI SBZ



**286-96-SBZ**  
3 3/4" CC  
5 1/8" Long



**286-128-SBZ**  
5" CC  
6 3/8" Long



**286-160-SBZ**  
6 1/4" CC  
7 11/16" Long



**286-192-SBZ**  
7 9/16" CC  
8 15/16" Long



**286-224-SBZ**  
8 13/16" CC  
10 3/16" Long

Item	1+	25+	100+
<b>286-96</b>	\$4.46	\$4.01	\$3.71
<b>286-128</b>	\$5.03	\$4.52	\$4.19
<b>286-160</b>	\$5.96	\$5.36	\$4.96
<b>286-192</b>	\$7.01	\$6.30	\$5.84
<b>286-224</b>	\$8.03	\$7.22	\$6.69

# JEFFREY ALEXANDER®

by Hardware Resources

## Lille

### AVAILABLE FINISHES



ABSB BNBDL DACM DBAC SN



**4155-DACM**  
Small Knob  
1 1/4" Dia.



**415-DACM**  
Large Knob  
1 3/8" Dia.

Item	1+	25+	100+
<b>4155</b>	\$3.18	\$2.86	\$2.65
<b>415</b>	\$4.34	\$3.90	\$3.61
<b>415-96</b>	\$3.80	\$3.42	\$3.16
<b>415-96V</b>	\$4.34	\$3.90	\$3.61
<b>415-128</b>	\$6.35	\$5.71	\$5.29
<b>415-160</b>	\$8.19	\$7.37	\$6.83
<b>415-12</b>	\$45.57	\$41.01	\$37.98



**415-96-DACM**  
3 3/4" CC  
4 3/8" Long



**415-96V-DACM**  
3 3/4" CC asymmetrical  
4 3/4" Long



**415-128-DACM**  
5" CC  
5 5/8" Long



**415-160-DACM**  
6 1/4" CC  
6 7/8" Long



**415-12-DACM**  
12" CC appliance pull  
12 7/8" Long

## Lyon

### AVAILABLE FINISHES

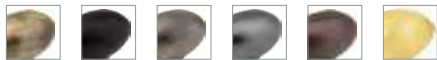

AB BLK BNBDL DACM DBAC BG



NI ORB PC SIM SN SBZ



**3991-PC**  
Egg Knob  
1 9/16" Dia.



**8233-PC**  
3" CC  
4 15/16" Long

Item	1+	25+	100+
<b>3991</b>	\$2.97	\$2.67	\$2.48
<b>8233</b>	\$2.52	\$2.27	\$2.10

JEFFREY ALEXANDER

## Marlo

AVAILABLE FINISHES



**972S-SN**  
Small knob  
7/8" Dia.



**972-SN**  
Medium knob  
1 1/8" Dia.



**972L-SN**  
Large knob  
1 1/4" Dia.

Item	1+	25+	100+
<b>972S</b>	\$2.37	\$2.13	\$1.98
<b>972</b>	\$2.90	\$2.61	\$2.41
<b>972L</b>	\$3.56	\$3.20	\$2.96
<b>972-96</b>	\$5.03	\$4.52	\$4.19
<b>972-128</b>	\$6.29	\$5.66	\$5.24
<b>972-160</b>	\$7.58	\$6.82	\$6.31
<b>972-224</b>	\$8.81	\$7.92	\$7.34
<b>972-305</b>	\$20.93	\$18.83	\$17.44
<b>972-12</b>	\$48.95	\$44.05	\$40.79



**972-96-SN**  
3 3/4" CC  
4 1/2" Long



**972-128-SN**  
5" CC  
5 13/16" Long



**972-160-SN**  
6 1/4" CC  
7 1/16" Long



**972-224-SN**  
8 13/16" CC  
9 3/4" Long



**972-305-SN**  
12" CC  
12 3/4" Long



**972-12-SN**  
12" CC appliance pull  
13" Long

JEFFREY ALEXANDER



## Maybeck

AVAILABLE FINISHES

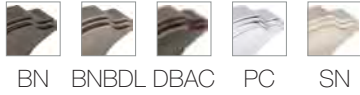

Item	1+	25+	100+
<b>225</b>	\$3.51	\$3.16	\$2.93
<b>225-96</b>	\$7.14	\$6.43	\$5.95
<b>225-128</b>	\$8.24	\$7.41	\$6.86
<b>225-160</b>	\$9.57	\$8.61	\$7.98



## Merrick

AVAILABLE FINISHES



Item	1+	25+	100+
<b>549-96</b>	\$2.78	\$2.50	\$2.31
<b>549-128</b>	\$3.18	\$2.86	\$2.65
<b>549-160</b>	\$3.60	\$3.24	\$3.00
<b>549-192</b>	\$4.07	\$3.66	\$3.39
<b>549-320</b>	\$10.67	\$9.60	\$8.89



**436-96-SN**  
Annadale

## Milan 1

AVAILABLE FINISHES



**1091-SN**  
Knob  
1 3/16" Dia.



**1092-SN**  
3 3/4" CC  
4 1/4" Long



**1092-128-SN**  
5" CC  
5 9/16" Long



**1092-160-SN**  
6 1/4" CC  
6 13/16" Long



**1092-12-SN**  
12" CC  
12 13/16" Long

Item	1+	25+	100+
<b>1091</b>	\$3.14	\$2.82	\$2.61
<b>1092</b>	\$3.53	\$3.17	\$2.94
<b>1092-128</b>	\$4.82	\$4.33	\$4.01
<b>1092-160</b>	\$5.76	\$5.18	\$4.80
<b>1092-12</b>	\$45.57	\$41.01	\$37.98

## Milan 2

AVAILABLE FINISHES



**1093-AEM**  
Knob  
1 3/16" Dia.



**1094-AEM**  
3 3/4" CC  
4 1/4" Long



**1094-128-AEM**  
5" CC  
5 9/16" Long



**1094-160-AEM**  
6 1/4" CC  
6 13/16" Long



**1094-12-AEM**  
12" CC appliance pull  
12 13/16" Long

Item	1+	25+	100+
<b>1093</b>	\$3.44	\$3.09	\$2.86
<b>1094</b>	\$4.28	\$3.85	\$3.56
<b>1094-128</b>	\$5.57	\$5.01	\$4.64
<b>1094-160</b>	\$5.94	\$5.35	\$4.95
<b>1094-12</b>	\$44.22	\$39.80	\$36.85

# JEFFREY ALEXANDER®

by Hardware Resources

## Mirada

### AVAILABLE FINISHES



ABSB BNBDL DBAC MB PC SN



**81021-PC**  
5/8" CC Knob  
1 9/16" Dia.

Item	1+	25+	100+
<b>81021</b>	\$1.89	\$1.70	\$1.58
<b>80152-96</b>	\$5.15	\$4.63	\$4.29
<b>80152-128</b>	\$5.82	\$5.24	\$4.85
<b>80152-160</b>	\$6.54	\$5.89	\$5.45



**80152-96-PC**  
3 3/4" CC  
5 9/16" Long



**80152-128-PC**  
5" CC  
6 13/16" Long



**80152-160-PC**  
6 1/4" CC  
8 1/16" Long

## Modena

### AVAILABLE FINISHES



PC SN SBN



**9105-SBN**  
Small knob  
1" Dia.



**910-SBN**  
Large knob  
1 3/16" Dia.

Item	1+	25+	100+
<b>9105</b>	\$2.81	\$2.52	\$2.34
<b>910</b>	\$3.51	\$3.16	\$2.93
<b>910-96</b>	\$4.86	\$4.37	\$4.05
<b>910-128</b>	\$6.36	\$5.72	\$5.30
<b>910-160</b>	\$7.05	\$6.35	\$5.88
<b>910-12</b>	\$48.95	\$44.05	\$40.79



**910-96-SBN**  
3 3/4" CC  
5 1/4" Long



**910-128-SBN**  
5" CC  
5 9/16" Long



**910-160-SBN**  
6 1/4" CC  
6 13/16" Long



**910-12-SBN**  
12" CC  
12 13/16" Long

JEFFREY ALEXANDER

## Montclair

AVAILABLE FINISHES



ABSB BNBDL DBAC SN



**935-SN**  
Knob  
2" Dia.



**935-96-SN**  
3 3/4" CC  
5 5/8" Long



**935-128-SN**  
5" CC  
7 1/2" Long



**935-160-SN**  
6 1/4" CC  
8 3/4" Long



**935-12-SN**  
12" CC appliance pull  
16" Long

Item	1+	25+	100+
<b>935</b>	\$4.74	\$4.27	\$3.95
<b>935-96</b>	\$6.60	\$5.94	\$5.50
<b>935-128</b>	\$8.36	\$7.52	\$6.96
<b>935-160</b>	\$9.14	\$8.22	\$7.61
<b>935-12</b>	\$58.73	\$52.85	\$48.94

## Prestige

AVAILABLE FINISHES



AEM BNBDL DP NI SN



**918-DP**  
Knob  
1 3/8" Dia.



**918L-DP**  
Knob  
2 1/4" Dia.



**918-96-DP**  
3 3/4" CC  
4 3/8" Long



**918-128-DP**  
5" CC  
5 11/16" Long



**918-160-DP**  
6 1/4" CC  
6 15/16" Long



**918-12-DP**  
12" CC appliance pull  
13 1/8" Long

Item	1+	25+	100+
<b>918</b>	\$5.09	\$4.58	\$4.24
<b>918L</b>	\$6.36	\$5.72	\$5.30
<b>918-96</b>	\$7.32	\$6.59	\$6.10
<b>918-128</b>	\$8.81	\$7.92	\$7.34
<b>918-160</b>	\$10.80	\$9.72	\$9.00
<b>918-12</b>	\$60.42	\$54.38	\$50.35

## Rae

### AVAILABLE FINISHES



BNBDL DBAC NI PC SN



**667S-NI**  
Small Knob  
1 1/16" Dia.



**667-NI**  
Knob  
1 1/4" Dia.



**667L-NI**  
Large Knob  
1 3/8" Dia.



**667-3-NI**  
3" CC  
3 7/16" Long



**667-96-NI**  
3 3/4" CC  
4 3/16" Long



**667-128-NI**  
5" CC  
5 1/2" Long



**667-160-NI**  
6 1/4" CC  
6 3/4" Long



**667-224-NI**  
8 13/16" CC  
9 1/4" Long



**667-305-NI**  
12" CC  
12 9/16" Long



**667-12-NI**  
12" CC appliance pull  
12 13/16" Long



**667-18-NI**  
18" CC appliance pull  
18 13/16" Long

Item	1+	25+	100+
<b>667S</b>	\$2.37	\$2.13	\$1.98
<b>667</b>	\$2.90	\$2.61	\$2.41
<b>667L</b>	\$3.56	\$3.20	\$2.96
<b>667-3</b>	\$3.72	\$3.35	\$3.10
<b>667-96</b>	\$5.03	\$4.52	\$4.19
<b>667-128</b>	\$6.29	\$5.66	\$5.24
<b>667-160</b>	\$7.58	\$6.82	\$6.31
<b>667-224</b>	\$8.81	\$7.92	\$7.34
<b>667-305</b>	\$20.93	\$18.83	\$17.44
<b>667-12</b>	\$45.57	\$41.01	\$37.98
<b>667-18</b>	\$57.21	\$51.49	\$47.68

## Regan

AVAILABLE FINISHES



DBAC SN PC BNBDL



**847-96-BNBDL**  
3 3/4" CC  
5 9/16" Long

**847-128-BNBDL**  
5" CC  
6 13/16" Long

**847-160-BNBDL**  
6 1/4" CC  
8 1/16" Long

Item	1+	25+	100+
<b>847-96</b>	\$1.95	\$1.76	\$1.63
<b>847-128</b>	\$2.28	\$2.05	\$1.90
<b>847-160</b>	\$2.61	\$2.35	\$2.18

## Regency

AVAILABLE FINISHES



ABSB SN SIM



**1097-SIM**  
Knob  
1 9/16" Dia.

**1099-SIM**  
Knob  
1 9/16" Dia.

**1098-SIM**  
3 3/4" CC  
5 1/2" Long

Item	1+	25+	100+
<b>1097</b>	\$2.51	\$2.25	\$2.09
<b>1098</b>	\$3.99	\$3.59	\$3.33
<b>1099</b>	\$2.51	\$2.25	\$2.09

## Rhodes

AVAILABLE FINISHES



BNB BNBDL DACM DBAC SN



**Z260-3-DACM**  
3" CC  
3 3/4" Long

**Z261-96-DACM**  
3 3/4" CC  
4 1/2" Long

**B812-96R-DACM**  
3 3/4" CC  
6" Long

**Z261-128-DACM**  
5" CC  
5 13/16" Long

**Z260-12-DACM**  
12" CC appliance pull  
13 1/4" Long

**S6060-DACM**  
Knob & backplate  
1 1/4" Dia.

Item	1+	25+	100+
<b>S6060</b>	\$2.13	\$1.92	\$1.78
<b>Z260-3</b>	\$1.89	\$1.70	\$1.58
<b>Z261-96</b>	\$2.04	\$1.84	\$1.70
<b>B812-96R</b>	\$3.15	\$2.84	\$2.63
<b>Z261-128</b>	\$5.60	\$5.04	\$4.66
<b>Z260-12</b>	\$45.57	\$41.01	\$37.98

# JEFFREY ALEXANDER®

by Hardware Resources

## Royce

AVAILABLE FINISHES



**431-PC**  
Knob  
1 3/16" Dia.



**595-PC**  
Knob  
1 1/4" Dia.

Item	1+	25+	100+
<b>431</b>	\$1.95	\$1.76	\$1.63
<b>595</b>	\$1.95	\$1.76	\$1.63
<b>798-96</b>	\$3.11	\$2.79	\$2.59
<b>798-128</b>	\$2.28	\$2.05	\$1.90
<b>798-160</b>	\$2.61	\$2.35	\$2.18



**798-96-PC**  
3 3/4" CC  
5 1/2" Long



**798-128-PC**  
5" CC  
6 3/4" Long



**798-160-PC**  
6 3/4" CC  
8 1/2" Long

## Solana

AVAILABLE FINISHES

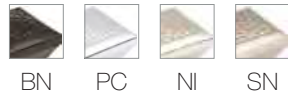

**457-BN**  
Knob  
1 1/4" Dia.



**457L-BN**  
Knob  
2" Dia.



**457-96-BN**  
3 3/4" CC  
6" Long

Item	1+	25+	100+
<b>457</b>	\$5.69	\$5.12	\$4.74
<b>457L</b>	\$5.87	\$5.28	\$4.89
<b>457-96</b>	\$7.83	\$7.05	\$6.53

## Sonoma

AVAILABLE FINISHES

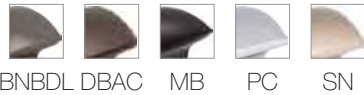

**4128-MB**  
5" CC  
6 5/16" Long



**4160-MB**  
6 1/4" CC  
8" Long



**4192-MB**  
9 5/8" CC  
6 5/16" Long



**431-MB**  
Knob  
1 3/16" Dia.

Item	1+	25+	100+
<b>431</b>	\$1.95	\$1.76	\$1.63
<b>4128</b>	\$3.81	\$3.43	\$3.18
<b>4160</b>	\$4.64	\$4.17	\$3.86
<b>4192</b>	\$6.83	\$6.14	\$5.69
<b>4288</b>	\$32.07	\$28.86	\$26.73

**4288-MB**  
11 3/8" CC  
14 7/16" Long

JEFFREY ALEXANDER



## Sullivan – NEW!

### AVAILABLE FINISHES



SN BNBDL DBAC MB PC



**752-96-DBAC**  
96MM CC  
4 1/2" Long

**752-128-DBAC**  
128MM CC  
5 13/16" Long

**752-160-DBAC**  
160MM CC  
7 1/16" Long

**752-192-DBAC**  
192MM CC  
8 15/16" Long

**752-224-DBAC**  
224MM CC  
9 9/16" Long



**752-19-DBAC**  
Knob  
1 1/4" Dia.

Item	1+	25+	100+
<b>752-19</b>	\$2.27	\$2.04	\$1.89
<b>752-96</b>	\$2.67	\$2.40	\$2.23
<b>752-128</b>	\$3.47	\$3.12	\$2.89
<b>752-160</b>	\$4.34	\$3.90	\$3.61
<b>752-192</b>	\$5.21	\$4.68	\$4.34
<b>752-224</b>	\$6.06	\$5.45	\$5.05

## Sutton

### AVAILABLE FINISHES



BG BNBDL DBAC MB NI



PC SBZ SN

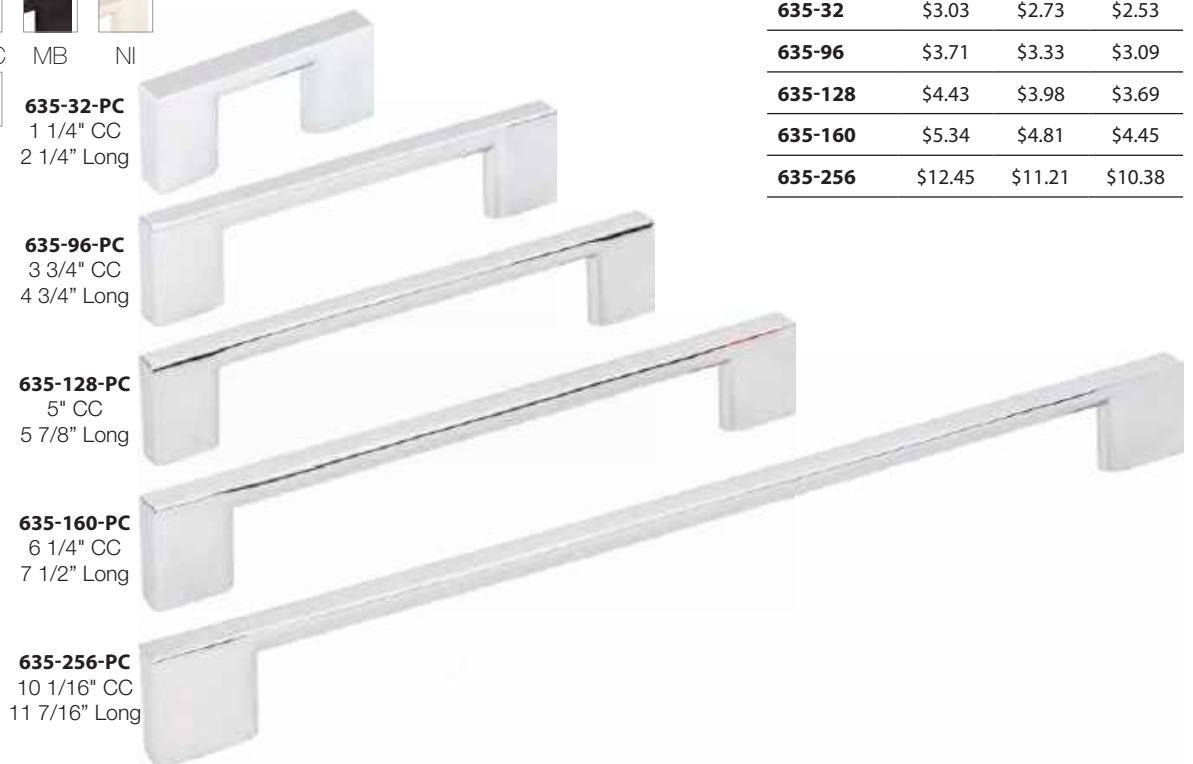

**635-32-PC**  
1 1/4" CC  
2 1/4" Long

**635-96-PC**  
3 3/4" CC  
4 3/4" Long

**635-128-PC**  
5" CC  
5 7/8" Long

**635-160-PC**  
6 1/4" CC  
7 1/2" Long

**635-256-PC**  
10 1/16" CC  
11 7/16" Long

Item	1+	25+	100+
<b>635-32</b>	\$3.03	\$2.73	\$2.53
<b>635-96</b>	\$3.71	\$3.33	\$3.09
<b>635-128</b>	\$4.43	\$3.98	\$3.69
<b>635-160</b>	\$5.34	\$4.81	\$4.45
<b>635-256</b>	\$12.45	\$11.21	\$10.38



## Symphony

AVAILABLE FINISHES



SN BNBDL DACM DBAC ABSB



**1976-ABSB**  
Knob  
2" Dia.



**1977S-ABSB**  
Knob  
1 3/8" Dia.



**1977-ABSB**  
3 3/4" CC  
4 9/16" Long

Item	1+	25+	100+
<b>1977S</b>	\$3.20	\$2.88	\$2.66
<b>1976</b>	\$3.84	\$3.46	\$3.20
<b>1977</b>	\$4.04	\$3.63	\$3.36

## Tahoe

AVAILABLE FINISHES



BLK DMAC SIM



**602S-SIM**  
Small knob  
1 1/4" Dia.



**602-SIM**  
Large knob  
1 1/2" Dia.



**602-96-SIM**  
3 3/4" CC  
4 1/2" Long



**602-128-SIM**  
5" CC  
5 9/16" Long



**602-12-SIM**  
12" CC  
12 3/4" Long

Item	1+	25+	100+
<b>602S</b>	\$4.98	\$4.48	\$4.15
<b>602</b>	\$5.24	\$4.71	\$4.36
<b>602-96</b>	\$6.45	\$5.81	\$5.38
<b>602-128</b>	\$7.91	\$7.11	\$6.59
<b>602-12</b>	\$48.95	\$44.05	\$40.79



**602-12-DMAC**  
Tahoe

# JEFFREY ALEXANDER®

by Hardware Resources

## Tiffany

AVAILABLE FINISHES



BG BNBDL DBAC NI PC SBZ SN



**658-SBZ**  
Knob  
1 1/4" Dia.

Item	1+	25+	100+
<b>658</b>	\$3.86	\$3.47	\$3.21
<b>658-96</b>	\$5.22	\$4.70	\$4.35
<b>658-128</b>	\$6.51	\$5.86	\$5.43
<b>658-160</b>	\$7.95	\$7.16	\$6.63
<b>658-192</b>	\$9.20	\$8.28	\$7.66
<b>658-224</b>	\$10.53	\$9.48	\$8.78
<b>658-12</b>	\$45.57	\$41.01	\$37.98



**658-96-SBZ**  
3 3/4" CC  
4 1/2" Long



**658-128-SBZ**  
5" CC  
5 13/16" Long



**658-160-SBZ**  
6 1/4" CC  
7 1/16" Long



**658-192-SBZ**  
7 9/16" CC  
8 3/8" Long

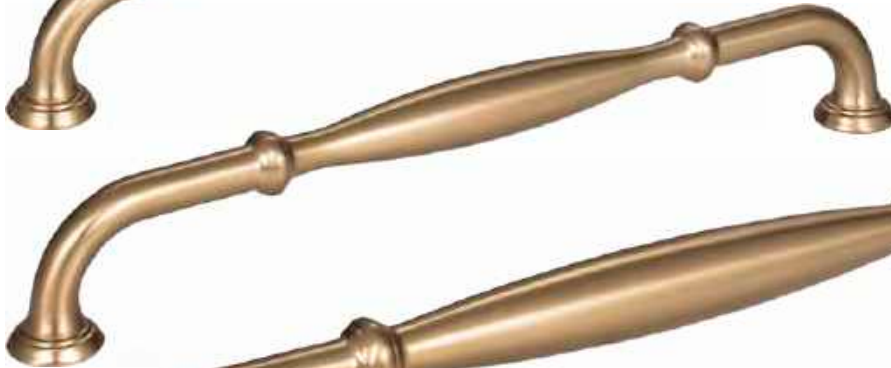

**658-224-SBZ**  
8 13/16" CC  
9 7/8" Long

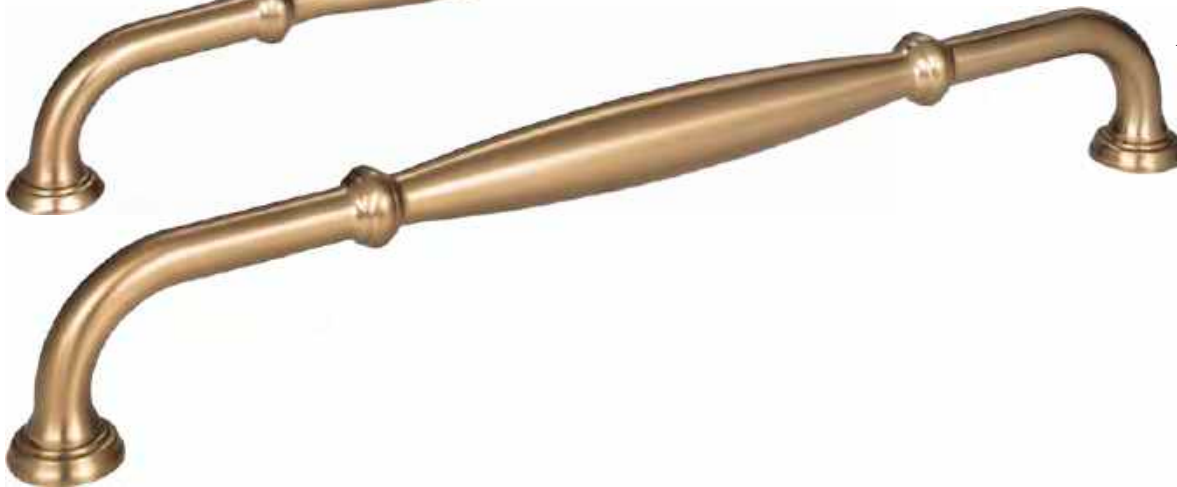

**658-12-SBZ**  
12" CC appliance pull  
13" Long

JEFFREY ALEXANDER

# JEFFREY ALEXANDER®

by Hardware Resources

## Tuscany

AVAILABLE FINISHES



ABSB DACM DBAC SIM



**749-96B-SIM**  
3 3/4" CC  
4 1/16" Long



**749-128B-SIM**  
5" CC  
5 5/16" Long



**749-128-SIM**  
5" CC bail pull  
5 5/16" Long



**749-160-SIM**  
6 1/4" CC bail pull  
7 3/16" Long



**749-224-SIM**  
8 3/16" CC bail pull  
9 3/4" Long



**749-SIM**  
Knob  
2 5/16" Dia.

Item	1+	25+	100+
<b>749</b>	\$2.54	\$2.28	\$2.11
<b>749-96B</b>	\$3.39	\$3.05	\$2.83
<b>749-128B</b>	\$3.63	\$3.27	\$3.03
<b>749-128</b>	\$4.43	\$3.98	\$3.69
<b>749-160</b>	\$5.69	\$5.12	\$4.74
<b>749-224</b>	\$6.33	\$5.70	\$5.28



**585-96-DP**  
Delmar

JEFFREY ALEXANDER

# JEFFREY ALEXANDER®

by Hardware Resources

## Zane

AVAILABLE FINISHES

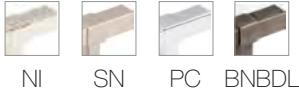

**293-96-BNBDL**  
3 3/4" CC  
5 1/16" Long

**293-128-BNBDL**  
5" CC  
6 7/16" Long

**293-160-BNBDL**  
6 1/4" CC  
7 9/16" Long

**293-192-BNBDL**  
7 9/16" CC  
8 13/16" Long

**293-224-BNBDL**  
8 13/16" CC  
10 1/16" Long

**293-305-BNBDL**  
12" CC  
13 3/4" Long

**293T-BNBDL**  
Knob  
2" Dia.

Item	1+	25+	100+
<b>293T</b>	\$3.00	\$2.70	\$2.50
<b>293-96</b>	\$4.58	\$4.12	\$3.81
<b>293-128</b>	\$5.33	\$4.79	\$4.44
<b>293-160</b>	\$6.18	\$5.56	\$5.15
<b>293-192</b>	\$7.14	\$6.43	\$5.95
<b>293-224</b>	\$8.15	\$7.33	\$6.79
<b>293-305</b>	\$20.93	\$18.83	\$17.44

JEFFREY ALEXANDER

## Zurich

AVAILABLE FINISHES



**I300-ABSB**  
3" CC  
3 9/16" Long

**I350-ABSB**  
Knob  
2" Dia.

**I350-128-ABSB**  
5" CC bail pull  
5 15/16" Long

**I350-160-ABSB**  
6 1/4" CC  
7 3/16" Long

Item	1+	25+	100+
<b>I350</b>	\$1.86	\$1.67	\$1.55
<b>I300</b>	\$3.33	\$3.00	\$2.78
<b>I350-128</b>	\$4.68	\$4.21	\$3.90
<b>I350-160</b>	\$5.34	\$4.81	\$4.45

E L E M E N T S<sup>®</sup>  
*by Hardware Resources*

## Aiden

AVAILABLE FINISHES



**993-BNBDL**  
Knob  
1 5/8" Proj.

Item	1+	25+	100+
<b>993</b>	\$1.17	\$1.05	\$0.98
<b>993-3</b>	\$1.97	\$1.77	\$1.64
<b>993-96</b>	\$2.37	\$2.13	\$1.98
<b>993-128</b>	\$3.12	\$2.81	\$2.60



**993-3-BNBDL**  
3" CC  
4 1/16" Long



**993-96-BNBDL**  
3 3/4" CC  
4 13/16" Long



**993-128-BNBDL**  
5 1/16" CC  
6 1/8" Long

## Arcadia

AVAILABLE FINISHES

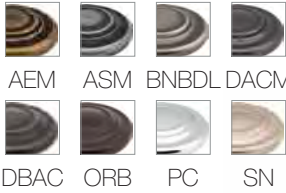

**516-AEM**  
3" CC  
5 1/2" Long



**107-AEM**  
Knob  
1 1/4" Dia.

Item	1+	25+	100+
<b>107</b>	\$1.83	\$1.65	\$1.53
<b>516</b>	\$1.83	\$1.65	\$1.53

## Asher

AVAILABLE FINISHES



**193-3-BC**  
3" CC  
3 1/4" Long



**193-96-BC**  
3 3/4" CC  
4" Long



**193-4-BC**  
4" CC  
4 1/4" Long



**193-128-BC**  
5" CC  
5 1/4" Long



**193-160-BC**  
6 1/4" CC  
6 9/16" Long

Item	1+	25+	100+
<b>193-3</b>	\$2.36	\$2.12	\$1.96
<b>193-96</b>	\$2.52	\$2.27	\$2.10
<b>193-4</b>	\$2.73	\$2.46	\$2.28
<b>193-128</b>	\$3.17	\$2.85	\$2.64
<b>193-160</b>	\$3.71	\$3.33	\$3.09

## Belfast

AVAILABLE FINISHES



BLK DN PC SN



**308-128-DN**  
5" CC  
5 1/2" Long

**406-128-DN**  
5" CC  
6 1/2" Long

**745-128-DN**  
5" CC  
5 1/2" Long

**776-128-DN**  
5" CC  
5 1/2" Long

**976-128-DN**  
5" CC  
6" Long

Item	1+	25+	100+
<b>308-128</b>	\$2.00	\$1.80	\$1.66
<b>406-128</b>	\$3.05	\$2.74	\$2.54
<b>745-128</b>	\$2.43	\$2.19	\$2.03
<b>776-128</b>	\$2.91	\$2.62	\$2.43
<b>976-128</b>	\$2.64	\$2.38	\$2.20

## Brenton

AVAILABLE FINISHES

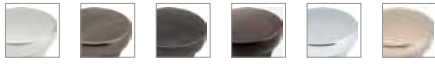

BC BNBDL DACM DBAC PC SN



**239-96-BNBDL**  
3 3/4" CC  
4 5/16" Long

**239-128-BNBDL**  
5" CC  
5 9/16" Long

**239-160-BNBDL**  
6 1/4" CC  
6 13/16" Long

**239-192-BNBDL**  
7 9/16" CC  
8 1/16" Long

**239-BDBDL**  
Knob  
1" Dia.

Item	1+	25+	100+
<b>239</b>	\$1.50	\$1.35	\$1.25
<b>239-96</b>	\$2.24	\$2.01	\$1.86
<b>239-128</b>	\$2.90	\$2.61	\$2.41
<b>239-160</b>	\$3.39	\$3.05	\$2.83
<b>239-192</b>	\$3.72	\$3.35	\$3.10

## Calloway

AVAILABLE FINISHES



BNBDL DBAC PC SN



**331-DBAC**  
Small Knob  
1 1/8" Dia.

**331L-DBAC**  
Large Knob  
1 1/4" Dia.

**351-DBAC**  
Small Knob  
1 1/8" Dia.

**351L-DBAC**  
Large Knob  
1 1/4" Dia.

**331-96-DBAC**  
3 3/4" CC  
4 1/2" Long

**351-96-DBAC**  
3 3/4" CC  
4 7/16" Long

**331-128-DBAC**  
5" CC  
5 3/4" Long

**351-128-DBAC**  
5" CC  
5 11/16" Long

Item	1+	25+	100+
<b>331</b>	\$1.26	\$1.13	\$1.05
<b>351</b>	\$1.38	\$1.24	\$1.15
<b>331L</b>	\$1.59	\$1.43	\$1.33
<b>351L</b>	\$1.71	\$1.54	\$1.43
<b>331-96</b>	\$2.36	\$2.12	\$1.96
<b>351-96</b>	\$2.52	\$2.27	\$2.10
<b>331-128</b>	\$2.61	\$2.35	\$2.18
<b>351-128</b>	\$2.75	\$2.47	\$2.29



## Capri

### AVAILABLE FINISHES



BB BC DN SN



**412461-SN**  
Knob  
1 1/8" Dia.



**530142-SN**  
Knob  
1" Dia.



**530143-DN**  
Knob  
1 1/4" Dia.

Item	1+	25+	100+
<b>412461</b>	\$1.19	\$1.07	\$0.99
<b>530142</b>	\$1.19	\$1.07	\$0.99
<b>530143</b>	\$1.19	\$1.07	\$0.99
<b>3211</b>	\$1.41	\$1.27	\$1.18
<b>4656</b>	\$1.89	\$1.70	\$1.58
<b>411689</b>	\$1.35	\$1.22	\$1.13
<b>4690</b>	\$1.38	\$1.24	\$1.15
<b>530144</b>	\$1.19	\$1.07	\$0.99
<b>417572</b>	\$1.77	\$1.59	\$1.48
<b>Z205</b>	\$2.04	\$1.84	\$1.70
<b>Z500-128</b>	\$4.11	\$3.70	\$3.43



**3211-SN**  
3" CC  
4 7/8" Long



**4656-SN**  
3" CC  
3 3/8" Long



**411689-DN**  
3 3/4" CC  
4 3/8" Long



**4690-SN**  
3 3/4" CC  
4 1/2" Long



**530144-DN**  
3 3/4" CC  
5 1/8" Long



**417572-DN**  
5" CC  
4 1/2" Long



**Z205-BB**  
5" CC  
5 3/4" Long



**Z500-128-SN**  
5" CC  
5 5/8" Long

NOTE: 412461, 530142, 3211, 4656, 4690 and Z500-128 are only available in SN Finish. 531043, 411689, 530144 and 417572 are only available in DN Finish. Z205 is only available in BB or BC Finishes.



## Cosgrove

AVAILABLE FINISHES

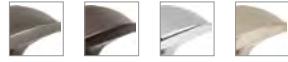

BNBDL DBAC PC SN

Item	1+	25+	100+
<b>382</b>	\$1.29	\$1.16	\$1.08
<b>382-96</b>	\$3.06	\$2.75	\$2.55
<b>382-128</b>	\$3.53	\$3.17	\$2.94
<b>382-160</b>	\$4.08	\$3.67	\$3.40



**382-96-BNBDL**  
3 3/4" CC  
6 1/2" Long



**382-BNBDL**  
Knob  
1 1/2" Dia.



**382-128-BNBDL**  
5" CC  
7 3/4" Long



**382-160-BNBDL**  
6 1/4" CC  
9" Long

## Cypress

AVAILABLE FINISHES

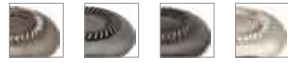

BNBDL DACM DBAC SN

Item	1+	25+	100+
<b>Z118</b>	\$0.95	\$0.85	\$0.79
<b>Z118-3</b>	\$1.14	\$1.03	\$0.95
<b>Z118-96</b>	\$1.29	\$1.16	\$1.08



**Z118-DACM**  
Knob  
1 1/4" Dia.



**Z118-3-DACM**  
3" CC  
3 3/8" Long



**Z118-96-DACM**  
3 3/4" CC  
4 1/8" Long

## Drake

AVAILABLE FINISHES



BNBDL DACM DBAC PC SN

Item	1+	25+	100+
<b>423</b>	\$1.73	\$1.55	\$1.44
<b>424</b>	\$1.83	\$1.65	\$1.53
<b>423-3</b>	\$1.86	\$1.67	\$1.55
<b>423-96</b>	\$2.19	\$1.97	\$1.83



**423-DBAC**  
Faceted Knob  
1 1/4" Dia.



**424-DBAC**  
Flat Top Knob  
1 3/16" Dia.



**423-3-DBAC**  
3" CC  
4" Long



**423-96-DBAC**  
3 3/4" CC  
4 3/4" Long

## Edgefield

AVAILABLE FINISHES

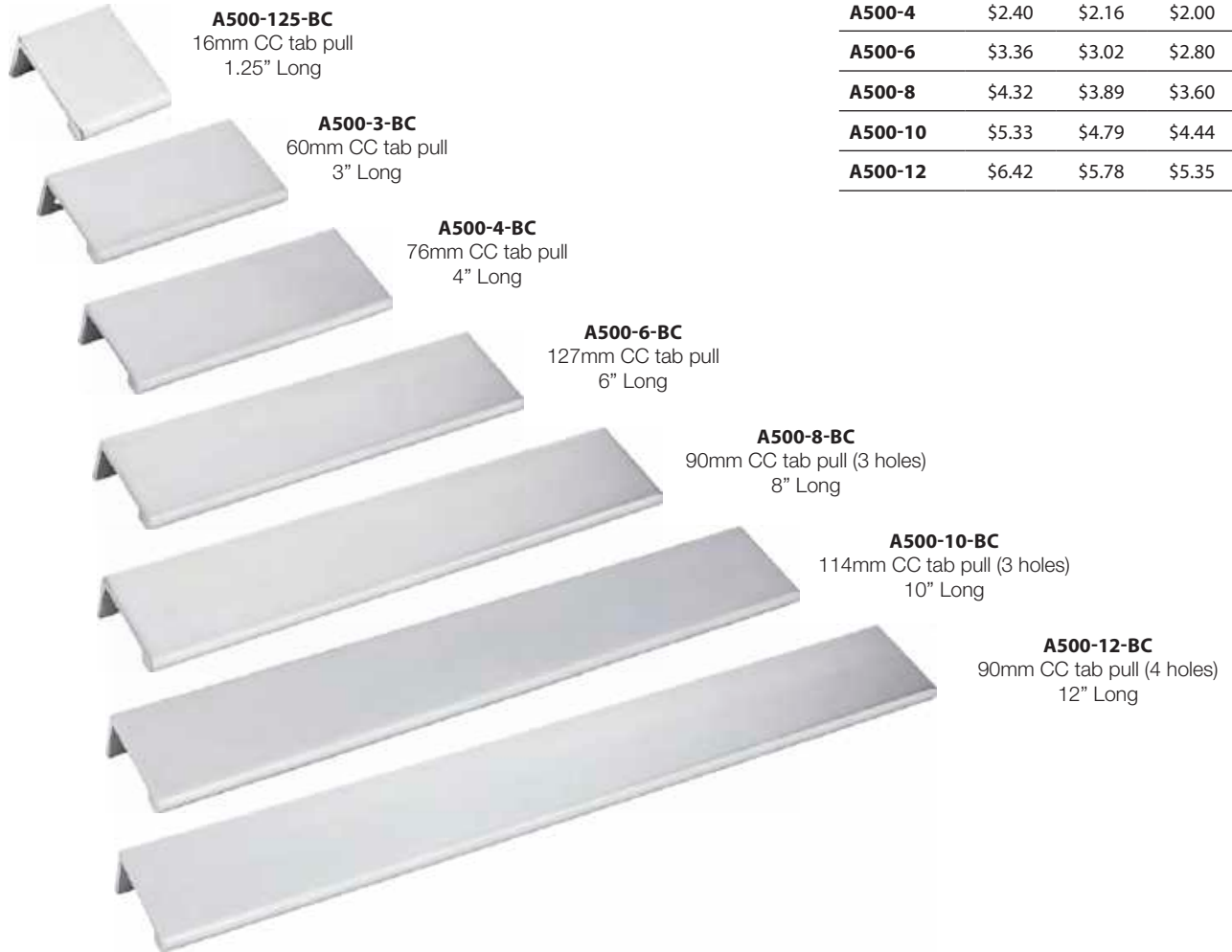
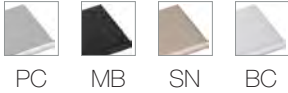

**A500-125-BC**  
16mm CC tab pull  
1.25" Long

**A500-3-BC**  
60mm CC tab pull  
3" Long

**A500-4-BC**  
76mm CC tab pull  
4" Long

**A500-6-BC**  
127mm CC tab pull  
6" Long

**A500-8-BC**  
90mm CC tab pull (3 holes)  
8" Long

**A500-10-BC**  
114mm CC tab pull (3 holes)  
10" Long

**A500-12-BC**  
90mm CC tab pull (4 holes)  
12" Long

Item	1+	25+	100+
<b>A500-125</b>	\$1.41	\$1.27	\$1.18
<b>A500-3</b>	\$1.95	\$1.76	\$1.63
<b>A500-4</b>	\$2.40	\$2.16	\$2.00
<b>A500-6</b>	\$3.36	\$3.02	\$2.80
<b>A500-8</b>	\$4.32	\$3.89	\$3.60
<b>A500-10</b>	\$5.33	\$4.79	\$4.44
<b>A500-12</b>	\$6.42	\$5.78	\$5.35

## Florence

AVAILABLE FINISHES

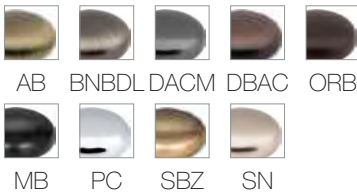

**2980-SBZ**  
Knob  
1 1/4" Dia.



**2981-SBZ**  
3" CC cup pull  
3 11/16" Long

Item	1+	25+	100+
<b>2980</b>	\$1.88	\$1.69	\$1.56
<b>2981</b>	\$2.46	\$2.21	\$2.05

## Gatsby

AVAILABLE FINISHES



BNBDL DACM DBAC PC SN



**3940-PC**  
Knob  
1 1/4" Dia.



**3950-PC**  
Knob  
1 3/16" Dia.



**3960-PC**  
Knob  
1 1/4" Dia.



**3970-PC**  
Knob  
1 1/8" Dia.

Item	1+	25+	100+
<b>3940</b>	\$0.83	\$0.74	\$0.69
<b>3950</b>	\$0.77	\$0.69	\$0.64
<b>3960</b>	\$1.14	\$1.03	\$0.95
<b>3970</b>	\$0.98	\$0.88	\$0.81
<b>3108</b>	\$1.20	\$1.08	\$1.00
<b>3208</b>	\$1.29	\$1.16	\$1.08
<b>3308</b>	\$1.31	\$1.17	\$1.09



**3108-PC**  
3" CC  
5 1/4" Long



**3208-PC**  
3" CC  
4 1/4" Long



**3308-PC**  
3" CC  
4 1/2" Long

## Glendale

AVAILABLE FINISHES



ABM-DBNBDL DBAC DMAC

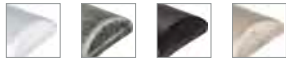

PC SIM MB SN



SBZ



**525-SIM**  
Knob  
1" Dia.



**525-96-SIM**  
3 3/4" CC  
5" Long

Item	1+	25+	100+
<b>525</b>	\$1.68	\$1.51	\$1.40
<b>525-96</b>	\$2.16	\$1.94	\$1.80



**993-128-DBAC**  
Aiden

## Hadly

AVAILABLE FINISHES



DBAC PC SN BNBDL



**449-BNBDL**  
Knob  
1" Dia.

Item	1+	25+	100+
<b>449</b>	\$1.59	\$1.43	\$1.33
<b>449-3</b>	\$2.28	\$2.05	\$1.90
<b>449-96</b>	\$2.61	\$2.35	\$2.18



**449-3-BNBDL**  
3" CC  
4" Long



**449-96-BNBDL**  
96 mm CC  
4 3/4" Long

## Hammond

AVAILABLE FINISHES



BNBDL DBAC PC SN



**525-SN**  
Knob  
1" Dia.

Item	1+	25+	100+
<b>525</b>	\$1.68	\$1.51	\$1.40
<b>937-3</b>	\$1.35	\$1.22	\$1.13
<b>937-96</b>	\$1.95	\$1.76	\$1.63



**937-3-SN**  
3" CC  
4 7/8" Long



**937-96-SN**  
3 3/4" CC  
5 11/16" Long

## Kenner

AVAILABLE FINISHES



PC BNBDL DBAC SN



**3970-SN**  
Knob  
1 1/8" Dia.

Item	1+	25+	100+
<b>3970</b>	\$0.98	\$0.88	\$0.81
<b>254-3</b>	\$1.35	\$1.22	\$1.13
<b>254-96</b>	\$1.95	\$1.76	\$1.63



**254-3-BNBDL**  
3" CC  
5" Long



**254-96-SN**  
3 3/4" CC  
5 3/4" Long

## Lindos

AVAILABLE FINISHES



BNBDL DBAC PC SN



**Z115-BNBDL**  
Knob  
1 1/4" Dia.



**Z115L-BNBDL**  
Knob  
1 3/8" Dia.

Item	1+	25+	100+
<b>Z115</b>	\$1.50	\$1.35	\$1.25
<b>Z115L</b>	\$1.38	\$1.24	\$1.15
<b>Z115-96</b>	\$1.76	\$1.58	\$1.46
<b>Z115-128</b>	\$4.67	\$4.20	\$3.89



**Z115-96-BNBDL**  
3 3/4" CC  
4 3/8" Long



**Z115-128-BNBDL**  
5" CC  
5 9/16" Long

## Madison

AVAILABLE FINISHES

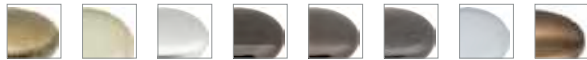

AB ALM BC BN BNBDL DACM WH SBZ  
DBAC MB ORB PB SB SN PC



**3910-AB**  
Knob  
1 3/16" Dia.

Item	1+	25+	100+
<b>3910</b>	\$1.23	\$1.11	\$1.03
<b>Z259-3</b>	\$1.41	\$1.27	\$1.18
<b>Z259-12</b>	\$45.57	\$41.01	\$37.98

NOTE: Z259-3 is not available in ALM or WH Finishes. Z259-12 is not available in ALM, BNBDL, MB, PB, SB or WH Finishes.



**Z259-3-AB**  
3" CC  
3 3/8" Long



**Z259-12-AB**  
12" CC appliance pull  
13" Long

## Naples

### AVAILABLE FINISHES



	<b>40-PC</b> Knob 40mm Dia.		
	<b>136-SN</b> 3" CC 156mm Long		
	<b>156-MB</b> 96mm CC 156mm Long		
	<b>176-BG</b> 128mm CC 176mm Long		
	<b>206-SBZ</b> 128mm CC 206mm Long		
	<b>220-PC</b> 160mm CC 220mm Long		
	<b>272-SN</b> 192mm CC 272mm Long		
	<b>304-MB</b> 224mm CC 304mm Long		
	<b>336-BG</b> 256mm CC 336mm Long		
	<b>368-SBZ</b> 288mm CC 368mm Long		
	<b>399-PC</b> 319mm CC 399mm Long		

Item	1+	25+	100+
40	\$1.32	\$1.19	\$1.10
136	\$1.82	\$1.63	\$1.51
156	\$2.16	\$1.94	\$1.80
176	\$2.61	\$2.35	\$2.18
206	\$3.24	\$2.92	\$2.70
220	\$2.87	\$2.58	\$2.39
272	\$3.30	\$2.97	\$2.75
304	\$3.57	\$3.21	\$2.98
336	\$3.90	\$3.51	\$3.25
368	\$4.20	\$3.78	\$3.50
399	\$4.56	\$4.10	\$3.80
496	\$5.48	\$4.93	\$4.56
560	\$6.11	\$5.49	\$5.09
624	\$6.77	\$6.09	\$5.64
720	\$7.77	\$6.99	\$6.48
763	\$8.22	\$7.40	\$6.85

**496**  
416mm CC  
496mm Long

**560**  
480mm CC  
560mm Long

**624**  
544mm CC  
624mm Long

**720**  
640mm CC  
720mm Long

**763**  
673mm CC  
763mm Long

**Naples**

AVAILABLE FINISHES



SS



**39-SS**  
Knob  
39mm Dia.



**154-SS**  
96mm CC  
154mm Long



**174-SS**  
128mm CC  
174mm Long



**204-SS**  
128mm CC  
204mm Long



**270-SS**  
192mm CC  
270mm Long



**302-SS**  
224mm CC  
302mm Long



**334-SS**  
256mm CC  
334mm Long



**366-SS**  
288mm CC  
366mm Long



**397-SS**  
319mm CC  
397mm Long

**494-SS**  
416mm CC  
494mm Long

**558-SS**  
480mm CC  
558mm Long

**622-SS**  
544mm CC  
622mm Long

**719-SS**  
640mm CC  
719mm Long

**761-SS**  
673mm CC  
761mm Long

Item	1+	25+	100+
<b>39</b>	\$1.10	\$0.99	\$0.91
<b>154</b>	\$1.65	\$1.49	\$1.38
<b>174</b>	\$2.16	\$1.94	\$1.80
<b>204</b>	\$2.87	\$2.58	\$2.39
<b>270</b>	\$3.06	\$2.75	\$2.55
<b>302</b>	\$3.30	\$2.97	\$2.75
<b>334</b>	\$3.42	\$3.08	\$2.85
<b>366</b>	\$3.74	\$3.36	\$3.11
<b>397</b>	\$4.11	\$3.70	\$3.43
<b>494</b>	\$5.06	\$4.55	\$4.21
<b>558</b>	\$5.60	\$5.04	\$4.66
<b>622</b>	\$6.11	\$5.49	\$5.09
<b>719</b>	\$6.90	\$6.21	\$5.75
<b>761</b>	\$7.38	\$6.64	\$6.15



## Merryville

AVAILABLE FINISHES

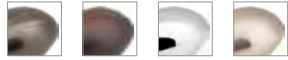

BNBDL DBAC PC SN



**897-BNBDL**  
Knob  
1 1/8" Dia.



**897L-BNBDL**  
Knob  
1 1/4" Dia.



**897-3-BNBDL**  
3" CC  
5 1/8" Long

Item	1+	25+	100+
<b>897</b>	\$1.23	\$1.11	\$1.03
<b>897L</b>	\$1.50	\$1.35	\$1.25
<b>897-3</b>	\$1.38	\$1.24	\$1.15

## Sedona

AVAILABLE FINISHES



SN



**26-SN**  
Knob  
1" Dia.



**400-SN**  
3" CC  
4" Long



**475-SN**  
3 3/4" CC  
4 3/4" Long



**600-SN**  
5" CC  
6" Long

Item	1+	25+	100+
<b>26</b>	\$1.50	\$1.35	\$1.25
<b>400</b>	\$2.43	\$2.19	\$2.03
<b>475</b>	\$3.05	\$2.74	\$2.54
<b>600</b>	\$4.20	\$3.78	\$3.50

**193-96-BC**  
Asher





## Slade

### AVAILABLE FINISHES

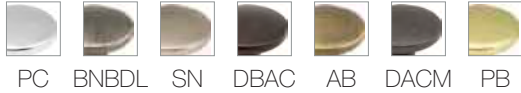

**3915-DACM**  
Knob  
1" Dia.

**984-3-DACM**  
3" CC  
3 1/2" Long

**984-96-DACM**  
3 3/4" CC  
4 1/4" Long

**984-128-DACM**  
5" CC  
5 1/2" Long

**984-160-DACM**  
6 1/4" CC  
6 3/4" Long

**984-192-DACM**  
7 9/16" CC  
8" Long

Item	1+	25+	100+
<b>3915</b>	\$0.90	\$0.81	\$0.75
<b>984-3</b>	\$1.56	\$1.40	\$1.30
<b>984-96</b>	\$1.80	\$1.62	\$1.50
<b>984-128</b>	\$2.04	\$1.84	\$1.70
<b>984-160</b>	\$2.37	\$2.13	\$1.98
<b>984-192</b>	\$2.72	\$2.44	\$2.26

NOTE: 984-3, 984-96, 984-128, 984-160 and 984-192 are not available in AB or PB Finishes.

## Somerset

### AVAILABLE FINISHES



**8004-DBAC**  
3 3/4" CC  
4 7/8" Long

**81065-DBAC**  
5" CC  
6" Long

**80814-DBAC**  
3 3/4" CC  
5" Long

**80815-DBAC**  
5" CC  
6 1/4" Long

Item	1+	25+	100+
<b>8004</b>	\$1.62	\$1.46	\$1.35
<b>81065</b>	\$1.92	\$1.73	\$1.60
<b>80814</b>	\$1.29	\$1.16	\$1.08
<b>80815</b>	\$1.92	\$1.73	\$1.60

## Stanton

AVAILABLE FINISHES

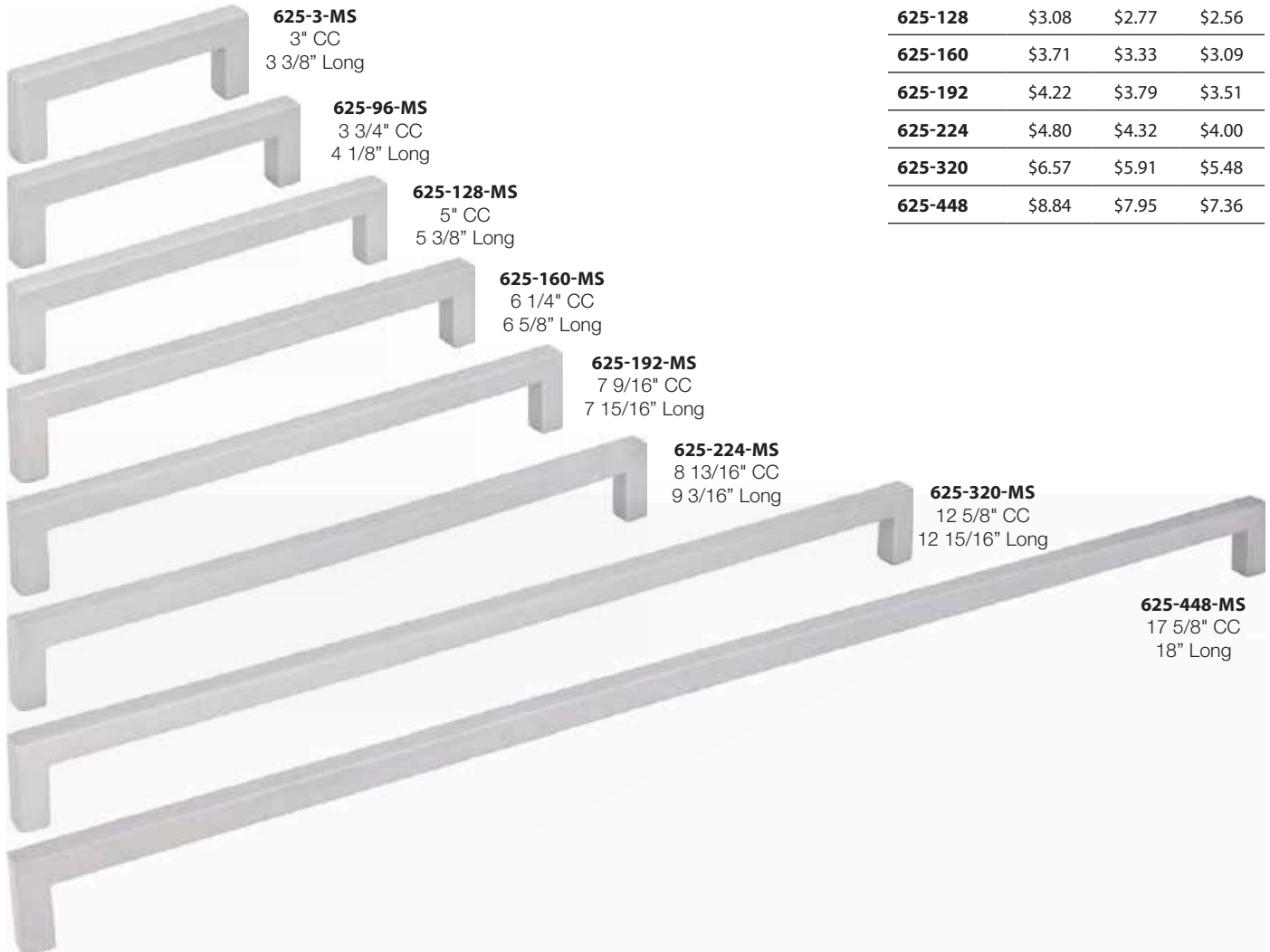

**625-3-MS**  
3" CC  
3 3/8" Long

**625-96-MS**  
3 3/4" CC  
4 1/8" Long

**625-128-MS**  
5" CC  
5 3/8" Long

**625-160-MS**  
6 1/4" CC  
6 5/8" Long

**625-192-MS**  
7 9/16" CC  
7 15/16" Long

**625-224-MS**  
8 13/16" CC  
9 3/16" Long

**625-320-MS**  
12 5/8" CC  
12 15/16" Long

**625-448-MS**  
17 5/8" CC  
18" Long

Item	1+	25+	100+
<b>625-3</b>	\$2.19	\$1.97	\$1.83
<b>625-96</b>	\$2.64	\$2.38	\$2.20
<b>625-128</b>	\$3.08	\$2.77	\$2.56
<b>625-160</b>	\$3.71	\$3.33	\$3.09
<b>625-192</b>	\$4.22	\$3.79	\$3.51
<b>625-224</b>	\$4.80	\$4.32	\$4.00
<b>625-320</b>	\$6.57	\$5.91	\$5.48
<b>625-448</b>	\$8.84	\$7.95	\$7.36

## Strickland

AVAILABLE FINISHES



**771-3-SN**  
3" CC  
4 1/2" Long

**771-128-SN**  
5" CC  
6 5/16" Long

**771-96-SN**  
3 3/4" CC  
5 3/16" Long

**771-160-SN**  
6 1/4" CC  
7 11/16" Long

Item	1+	25+	100+
<b>771-3</b>	\$2.34	\$2.11	\$1.95
<b>771-96</b>	\$2.49	\$2.24	\$2.08
<b>771-128</b>	\$2.90	\$2.61	\$2.41
<b>771-160</b>	\$3.42	\$3.08	\$2.85

## Syracuse

AVAILABLE FINISHES



BNBDL DBAC PC SN



**575-96-BNBDL**  
3 3/4" CC  
4 7/8" Long



**575-BNBDL**  
Knob  
1 3/16" Dia.

Item	1+	25+	100+
<b>575</b>	\$1.26	\$1.13	\$1.05
<b>575-96</b>	\$2.52	\$2.27	\$2.10

## Torino

AVAILABLE FINISHES



AL SS WH ALM BC DBAC PB PC SN



**A271-3AL**  
3" CC  
3 3/8" Long



**K271-3SS**  
3" CC  
3 3/8" Long



**P271-3-WH**  
3" CC  
3 3/8" Long



**S271-3-PB**  
3" CC  
3 3/8" Long



**A271-3.5AL**  
3 1/2" CC  
3 13/16" Long



**K271-3.5-SS**  
3 1/2" CC  
3 13/16" Long



**S271-3.5-PB**  
3 1/2" CC  
3 13/16" Long



**A271-96AL**  
3 3/4" CC  
4 1/8" Long



**K271-96-SS**  
3 3/4" CC  
4 1/8" Long



**P271-96-WH**  
3 3/4" CC  
4 1/8" Long



**S271-96-PB**  
3 3/4" CC  
4 1/8" Long



**A271-4AL**  
4" CC  
4 5/16" Long



**K271-4SS**  
4" CC  
4 5/16" Long



**S271-4-PB**  
4" CC  
4 5/16" Long



**S271-128-PB**  
5" CC  
5 3/8" Long

Item	1+	25+	100+
<b>A271-3AL</b>	\$0.68	\$0.61	\$0.56
<b>K271-3SS</b>	\$1.89	\$1.70	\$1.58
<b>P271-3-WH</b>	\$0.27	\$0.24	\$0.23
<b>S271-3</b>	\$0.92	\$0.82	\$0.76
<b>A271-3.5AL</b>	\$0.71	\$0.63	\$0.59
<b>K271-3.5-SS</b>	\$1.73	\$1.55	\$1.44
<b>S271-3.5</b>	\$0.95	\$0.85	\$0.79
<b>A271-96AL</b>	\$0.72	\$0.65	\$0.60
<b>K271-96-SS</b>	\$1.79	\$1.61	\$1.49
<b>P271-96-WH</b>	\$0.32	\$0.28	\$0.26
<b>S271-96</b>	\$0.99	\$0.89	\$0.83
<b>A271-4AL</b>	\$0.75	\$0.68	\$0.63
<b>K271-4SS</b>	\$2.12	\$1.90	\$1.76
<b>S271-4</b>	\$1.02	\$0.92	\$0.85
<b>S271-128</b>	\$1.02	\$0.92	\$0.85

## Vienna

### AVAILABLE FINISHES



DBAC SN AB



PBM PCM SB



**110-DBAC**  
Knob  
1 1/4" Dia.



**202-DBAC**  
Knob  
1 1/4" Dia.



**110-3-DBAC**  
3" CC  
5 1/2" Long



**P106-DBAC**  
3" CC  
5" Long

Item	1+	25+	100+
<b>110</b>	\$1.14	\$1.03	\$0.95
<b>202</b>	\$0.83	\$0.74	\$0.69
<b>110-3</b>	\$1.71	\$1.54	\$1.43
<b>P106</b>	\$1.29	\$1.16	\$1.08

NOTE: AB Finish is only available for 202. PBM, PCM or SB Finishes are only available for P106.

## Watervale

### AVAILABLE FINISHES

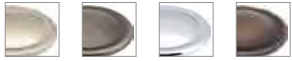

SN BNBDL PC DBAC

Item	1+	25+	100+
<b>647</b>	\$1.08	\$0.97	\$0.90
<b>647-3</b>	\$1.35	\$1.22	\$1.13
<b>647-96</b>	\$1.95	\$1.76	\$1.63



**647-DBAC**  
Knob  
1 1/8" Dia.



**647-3-DBAC**  
3" CC  
4 5/8" Long



**647-96-DBAC**  
3 3/4" CC  
5 3/8" Long

## Westbury

### AVAILABLE FINISHES



BNBDL DBAC PC SN

Item	1+	25+	100+
<b>3898</b>	\$1.68	\$1.51	\$1.40
<b>3899</b>	\$1.38	\$1.24	\$1.15



**3898-PC**  
Knob  
1 1/4" Dia.



**3899-PC**  
3" CC  
5 1/8" Long

## Zachary

### AVAILABLE FINISHES

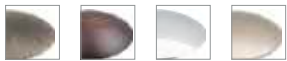

BNBDL DBAC PC SN

**988-SN**  
Knob  
1 1/6" Dia.



**988-3-SN**  
3" CC  
3 3/4" Long



**988-96-SN**  
3 3/4" CC  
4 1/2" Long



**988-128-SN**  
5" CC  
5 3/4" Long



**988-160-SN**  
6 1/4" CC  
7 1/16" Long

Item	1+	25+	100+
<b>988</b>	\$1.13	\$1.01	\$0.94
<b>988-3</b>	\$1.50	\$1.35	\$1.25
<b>988-96</b>	\$2.07	\$1.86	\$1.73
<b>988-128</b>	\$2.43	\$2.19	\$2.03
<b>988-160</b>	\$3.00	\$2.70	\$2.50



**TK** | TOP KNOBS

*Full Line Available - Authorized Distributor*  
*Call for Pricing: 330-897-0002 or 330-897-7701*



Full Line Available - Authorized Distributor  
Call for Pricing: 330-897-0002 or 330-897-7701



# *functional hardware*

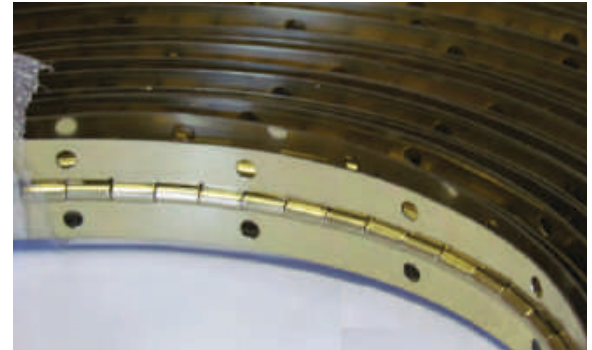

## KOMBI 47 SYNCHRONIZED BALL BEARING TABLE SLIDE - **NEW!**

**PÖTTKER**

MADE IN GERMANY

Transforming furniture

WITH 90° ANGLE  
FOOT BRACKETS



WITH VERTICAL  
FOOT BRACKETS



**Your One-Hand  
Movement Solution  
for Pedestal Tables**



ITEM	LENGTH	WAY OF TRAVEL	1+	10+	25+
<b>47120717</b>	48"	50"	\$92.00	\$87.00	\$85.00
<b>47070702</b>	28"	29"	\$79.00	\$75.00	\$72.00

CALL FOR SKID PRICING

ITEM	LENGTH	WAY OF TRAVEL	1+	10+	25+
<b>47120762</b>	48"	49"	\$90.00	\$85.00	\$82.00
<b>47091702</b>	36"	36¾"	\$80.00	\$77.50	\$74.50
<b>47070710</b>	28"	28"	\$75.00	\$72.50	\$69.50

CALL FOR SKID PRICING

## CLASSIC TELESCOPIC BALL BEARING TABLE SLIDE - **NEW!**

**PÖTTKER**

MADE IN GERMANY

Transforming furniture



**Ball Bearing Slide for  
Standard Four Leg  
Split-Frame Tables**



ITEM	LENGTH	WAY OF TRAVEL	1+	10+	25+
<b>47097502</b>	38"	45"	\$57.00	\$52.00	\$48.50
<b>47074524</b>	29"	40"	\$38.00	\$35.25	\$32.00

CALL FOR SKID PRICING

## FRONTSIDE BASIC - **NEW!**

**PÖTTKER**

MADE IN GERMANY

Transforming furniture

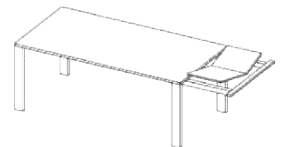
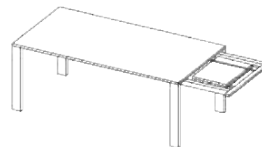
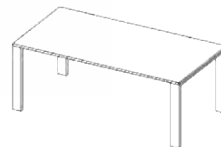

ITEM	LENGTH	WAY OF TRAVEL	1+	10+	25+
<b>47061101</b>	24"	26"	\$45.00	\$40.00	\$37.50

CALL FOR SKID PRICING

## ALU 55 UNIVERSAL - **NEW!**

- EQUIPPED WITH BALL BEARING-SUPPORTED CASTORS
- CAN BE USED FOR VARIABLE TABLE SYSTEMS
- SUITABLE FOR SMALL QUANTITIES
- AVAILABLE AS FRONTSIDE SYSTEM
- AVAILABLE AS STANDARD SLIDE
- AVAILABLE AS FRONTSIDE BASIC
- CAN BE USED FOR ALL DOOR TOP MATERIALS
- INCLUDES FRONTEND CROSSBAR WITH SELF-CUTTING SCREWS
- CAN BE CUT TO SIZE IN A FEW STEPS:  
CUT TO LENGTH - MILL / DRILL - ASSEMBLY



**PÖTTKER** MADE IN USA  
Transforming furniture

**Call for a Quote**



FOLDING MECHANISM PARTS - **NEW!**

**PÖTTKER**

MADE IN GERMANY

Transforming furniture



**15853**  
180° HINGE  
DIMENSION: 12.6 X 60.7 MM  
TABLE LEAF THICKNESS: 22 - 30 MM



**15854**  
180° HINGE  
DIMENSION: 15.3 X 69.9 MM  
TABLE LEAF THICKNESS: 28 - 40 MM



**23010901**  
4" ALUMINUM SPACER TUBE FOR THE FOLDING MECHANISM AND FLAT FOLDING MECHANISM



**14087**  
SUPPORT ROLLING UNIT FOR USE WITH TUBE65



**56990383-49**  
ROCKER FOR FOLDING LEAF



**16079**  
TUBE CLIP FOR USE WITH TUBE65



**TUBE65**  
65" TUBE  
DOUBLE ZINC SUPPORT AS STANDARD TUBE FOR THE FOLDING MECHANISM

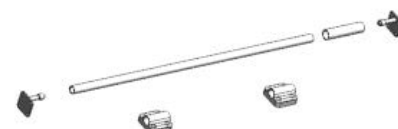

**15032**  
PFM FOLDING MECHANISM  
CENTRALLY LOCATED TABLE BASE, PEDESTAL FOR CLOSED STORAGE BOX  
FAVOURABLY PRICED AND EFFECTIVE FOR TABLE LEAF INSERTS 500 MM, 5 PIECES

ITEM	1+	25+	100+
<b>15853</b>	\$5.25	\$4.85	\$4.25
<b>15854</b>	\$9.45	\$8.25	\$7.75
<b>16079</b>	\$2.50	\$2.25	\$1.95
<b>23010901</b>	\$3.00	\$2.75	\$2.50
<b>TUBE65</b>	\$17.50	\$16.50	\$15.95
<b>14087</b>	\$3.50	\$3.25	\$2.85
<b>15032</b>	\$14.95	\$13.75	\$12.50
<b>56990383-49</b>	\$10.50	\$9.95	\$9.25

TABLE COMPONENTS - **NEW!**

**PÖTTKER**

MADE IN GERMANY

Transforming furniture



**16084**  
SLIP-RESISTANT SURFACE  
INSTALLATION DIMENSION: Ø 36 X 24 MM



**16083**  
CASTOR CUSHIONED Ø 25 MM  
INSTALLATION DIMENSION: Ø 36 X 24 MM



**15827**  
CASTOR



**16080**  
BALANCE SAFEGUARD



**16106**  
RAISE SAFEGUARD



**15968**  
TENSION SPRING



**15065**  
TURNED STEEL, SET TABLE LEAF PINS

ITEM	1+	25+	100+
<b>16084</b>	\$3.65	\$3.42	\$3.02
<b>16083</b>	\$3.65	\$3.42	\$3.02
<b>15968</b>	\$3.15	\$2.95	\$2.63
<b>15065</b>	\$0.75	\$0.65	\$0.55
<b>15827</b>	\$1.35	\$1.25	\$1.10
<b>16080</b>	\$0.95	\$0.90	\$0.80
<b>16106</b>	\$1.25	\$1.10	\$0.99

V STABILIZER BARS - **NEW!**

**PÖTTKER**

MADE IN GERMANY

Transforming furniture



**V STABILIZER BAR**  
AVAILABLE IN 15½" - 72" LENGTHS



**VSB-BIT**  
FOR USE WITH V STABILIZER BARS

ITEM	LENGTH	1+	50+	100+
<b>16829</b>	15½"	\$6.35	\$5.05	\$4.55
<b>16830</b>	18"	\$6.50	\$5.50	\$4.95
<b>16831</b>	21"	\$6.68	\$6.01	\$5.56
<b>16832</b>	24"	\$7.40	\$6.66	\$6.16
<b>16833</b>	26"	\$7.77	\$6.99	\$6.48
<b>16834</b>	30"	\$9.20	\$8.28	\$7.66
<b>16835</b>	36"	\$11.04	\$9.94	\$9.20
<b>16836</b>	42"	\$12.78	\$11.50	\$10.65
<b>16840</b>	48"	\$13.19	\$11.87	\$10.99
<b>16839</b>	60"	\$18.87	\$16.98	\$15.73
<b>16837</b>	72" (NO HOLES)	\$29.86	\$27.73	\$25.60
<b>VSB-BIT</b>	-	\$195.00	-	-

## SLIDING DOOR HARDWARE

- FOR USE WITH 1-3/8" TO 1-3/4" WOOD DOOR
- MAX. LOADING WEIGHT: 220 LBS
- KIT INCLUDES:
  - 2 - HOOK CARRIER 2-3/4" WHEEL
  - 1 - RAIL 78-3/4" LONG WITH 5 MOUNTING BRACKETS
  - 2 - RAIL STOPS
  - 2 - ANTI-JUMP BLOCKS
  - 1 PLASTIC FLOOR CENTER GUIDE FOR WOOD DOOR
- AVAILABLE IN THREE POPULAR FINISHES



ITEM	1 SET	4 Sets
<b>SDH-1409W-BL</b>	\$85.00	\$77.50
<b>SDH-1409W-SN</b>	\$120.00	\$115.00
<b>SDH-1409W-ORB</b>	\$95.00	\$87.50
<b>SDH-1424-SC</b>	\$30.00	\$29.00
<b>SDH-1419-BL</b>	\$3.95	—
<b>SDH-BYPASS</b>	\$14.95	—

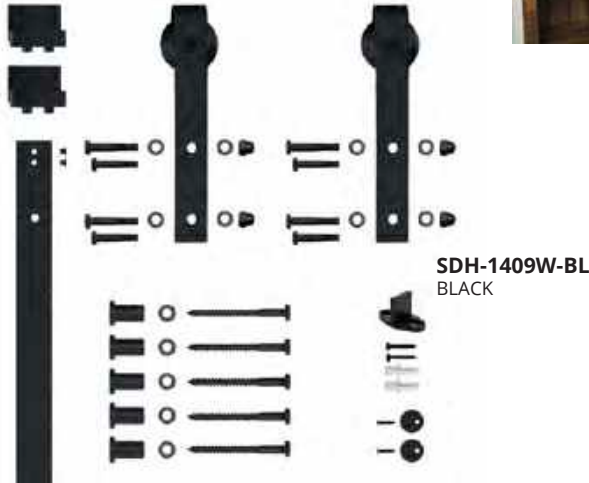

**SDH-1409W-BL**  
BLACK



### SOFT-CLOSE MECHANISM

#### SDH-1424-SC

- 2 - SOFT CLOSE MECHANISM (L & R)
- 2 - ACTUATOR
- ALL HARDWARE



**SDH-1409W-SN**  
SATIN NICKEL



**SDH-1409W-ORB**  
OIL-RUBBED BRONZE



### STEEL RAIL CONNECTOR

#### SDH-1419-BL

- 1 - CONNECTOR
- 4 - FLAT HEAD SCREWS 1/4-20 THREAD



### BYPASS DOOR BRACKET

#### SDH-BYPASS

- 2 - HEX SCREWS W/ WASHERS
- 1 - HEX BOLT W/ WASHERS & NUT

## EUROPEAN SLIDING DOOR HARDWARE

- KIT INCLUDES
  - (2 - TOP MOUNT HANGING BRACKETS FOR SDH-141W-SS) OR (2 - STRAP HANGING BRACKETS FOR SDH-145WG-SS)
  - 1 - RAIL, 2M (78-3/4")
  - 4 - MOUNTING BRACKETS
  - 2 - END STOPS
  - 1 - FLOOR CENTER GUIDE
  - 1 - SPANNER TOOL SET
  - ALL HARDWARE AND INSTALLATION INSTRUCTIONS

ITEM	1 SET	4 SETS
<b>SDH-141W-SS</b>	\$145.00	\$137.00
<b>SDH-145WG-SS</b>	\$185.00	\$175.00



**SDH-141W-SS**  
STAINLESS STEEL  
TOP MOUNT  
FOR WOOD DOORS



**SDH-145WG-SS**  
STAINLESS STEEL

- FOR WOOD OR GLASS DOORS
- MAX WOOD DOOR THICKNESS 1 9/16"
  - MAX GLASS DOOR THICKNESS 12MM

# CUSTOM MINI BARN DOOR TRACK - *NEW!*



**SDH-875**  
SPACER FOR  
1" DOORS



**SDH-688**  
1 1/16" SPACER  
FOR 3/4" DOORS

ITEM	UP TO 78"	79"+
<b>SDH-CUSTOM ?"</b>	\$0.32/INCH	\$0.40/INCH



**CB1445LP-BL**  
1/4 20 X 45MM (1.77")

ITEM	1+	50+	100 PCS.
<b>CB1445LP-BL</b>	\$0.25	—	\$19.50
<b>A313</b>	\$0.20	—	\$18.50
<b>SDH-688</b>	\$2.45	\$2.10	—
<b>SDH-875</b>	\$2.50	\$2.15	—

APPROXIMATELY 7-10 DAY LEAD TIME.  
CALL FOR QUANTITY PRICING!

## MINI BARN DOOR HARDWARE

- SPECIALLY MADE FOR FURNITURE
- EACH MINI BARN DOOR HARDWARE KIT INCLUDES:  
2 - MINI STRAPS WITH ROLLERS  
2 - RAIL END STOPS
- (KITS ONLY AVAILABLE IN BLACK)
- (RAIL KITS ARE NOT INCLUDED BUT ARE REQUIRED)



HOOK, ROUND END KIT  
1.00" W X 6.50" H  
**SDH-1301**



DOUBLE DIAMOND KIT  
2.00" W X 6.50" H  
**SDH-1405**



WEDGE KIT  
1.25" W X 6.25" H  
**SDH-1402**



HORSESHOE KIT  
3.25" W X 3.50" H  
**SDH-1408**



TOP MOUNT KIT  
3.00" W X 2.25" H  
**SDH-1403**



FRONT MOUNT KIT  
3.00" W X 3.00" H  
**SDH-1404**

ITEM	WIDTH	HEIGHT	1 KIT	10 KITS	20 KITS
<b>SDH-1301</b>	1"	6.5"	\$38.50	\$33.50	\$31.25
<b>SDH-1402</b>	1.25"	6.25"	\$38.50	\$33.50	\$31.25
<b>SDH-1403</b>	3"	2.25"	\$38.50	\$33.50	\$31.25
<b>SDH-1404</b>	3"	3"	\$38.50	\$33.50	\$31.25
<b>SDH-1405</b>	2"	6.5"	\$38.50	\$33.50	\$31.25
<b>SDH-1408</b>	3"	6.5"	\$38.50	\$33.50	\$31.25
<b>SDH-1324SC</b>			\$17.50	\$16.00	—
<b>SDH-J34</b>			\$4.50	—	\$3.75
<b>SDH-J150</b>			\$5.50	—	\$4.75



3/4" BOTTOM DOOR GUIDE  
**SDH-J34**



1 1/2" BOTTOM DOOR GUIDE  
**SDH-J150**



SOFT-CLOSE MECHANISM  
**SDH-1324-SC**

- 2 - SOFT CLOSE MECHANISM (L & R)
- 2 - ACTUATOR
- ALL HARDWARE

## RAIL KIT

- MUST BE PURCHASED IN ADDITION TO ROLLER HARDWARE KITS
- INCLUDES A STEEL RAIL (1" WIDE X 1/8" THICK), SPACERS, WASHERS, AND MOUNTING BOLTS.

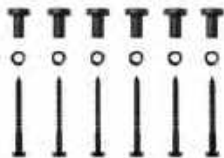

ITEM	RAIL LENGTH	RAIL WIDTH	1 KIT	10 KITS	20 KITS
<b>SDH-1348</b>	4'	1"	\$19.95	\$17.50	\$15.95
<b>SDH-1360</b>	5'	1"	\$23.95	\$20.95	\$19.50
<b>SDH-1372</b>	6'	1"	\$27.95	\$24.50	\$22.95
<b>SDH-MINIBYPASS</b>			\$19.95	—	—

BYPASS DOOR BRACKET  
**SDH-MINIBYPASS**

- 2 - HEX SCREWS W/ WASHERS
- 1 - HEX BOLT W/ WASHERS & NUT

## SLIDING WOOD DOOR TRACK - *NEW!*



**P721006-B**  
TRACK

- 78 3/4" LONG
- CUT GROOVE 6MM WIDE X 7MM DEEP
- CAN BE USED FOR TOP AND BOTTOM TRACKS
- STOCKED IN BROWN
- ALSO AVAILABLE IN WHITE, OAK, OR BLACK IN SPECIAL ORDER

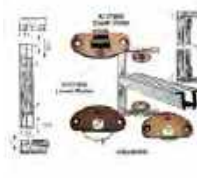

**X721900**

1 SET PER DOOR

- 30MM HOLE DIAMETER
- CENTER OF HOLE 7MM FROM EDGE OF DOOR
- DRILL HOLE 9MM DEEP
- CUT DOOR 1/4" SMALLER THAN OPENING
- 25 LB CAPACITY

ITEM	1 PC.	25 PC.	50 PC.
<b>X721900</b>	\$9.50	\$8.75	\$8.25
<b>P721006-B</b>	\$4.50	\$4.25	\$3.95

## CONTINUOUS CHEST HINGES

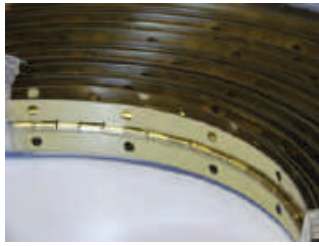

**V26-BP**  
BRASS PLATED  
1 1/4" W X 100' L

**V26A-BP**  
BRASS PLATED  
1 1/2" W X 100' L

ITEM	ROLL
V26-BP	\$99.00
V26A-BP	\$115.00

ORDER SCREWS  
SEPARATELY



**V28A-BL**  
BLACK  
1 1/2" W X 6' L



**V28-PB**  
POLISHED BRASS  
1 1/4" W X 6' L

ITEM	1+	10+
V28-PB	\$8.25	\$7.95
V28A-PB	\$8.25	\$7.95
V28A-BL	\$14.50	\$13.95

SCREWS INCLUDED

**V28A-PB**  
POLISHED BRASS  
1 1/2" W X 6' L

## FLAT BACK CHEST HINGE



**V29-BP**  
BRASS PLATED  
1 5/8" W X 2" H



**V29A-AB**  
ANTIQUÉ BRASS  
1 5/8" W X 2 1/2" H

**V29A-BP**  
BRASS PLATED  
1 5/8" W X 2 1/2" H

**V29A-BL**  
BLACK  
1 5/8" W X 2 1/2" H

ITEM	1+	100+
V29-BP	\$0.75	\$0.55
V29A-AB	\$0.80	\$0.63
V29A-BP	\$0.80	\$0.63
V29A-BL	\$0.80	\$0.63

## MINIATURE BRASS



**LD228**  
BRASS PLATED  
1" W X 1 1/4" H



**LD2039**  
POLISHED BRASS  
1 3/4" W X 3/4" H



**LD2200**  
BRASS PLATED  
1 1/4" W X 1 1/4" H  
.035 METAL



**LD250**  
BRASS PLATED  
3/4" W X 1" H

**LD300**  
BRASS PLATED  
1 1/16" W X 1" H



**LD2025**  
BRASS PLATED  
1 1/2" W X 1 1/2" H



**LD262**  
BRASS PLATED  
3/4" W X 1" H



**LD1270**  
BRASS PLATED



**FLATHEAD/ROUNDHEAD**  
FH-2 X 3/8  
ROUNDHEAD BRASS  
RH-2 X 3/8  
ROUNDHEAD  
RH-4 X 3/8

ITEM	1+	100+
FH-2 X 3/8	\$0.05	\$0.03
LD1270	\$1.00	\$0.85
LD2025	\$0.70	\$0.60
LD2039	\$0.70	\$0.60
LD2200	\$0.70	\$0.60
LD228	\$0.70	\$0.60
LD250	\$0.70	\$0.60
LD262	\$0.70	\$0.60
LD300	\$0.70	\$0.60
RH-2 X 3/8	\$0.05	\$0.03
RH-4 X 3/8	\$0.05	\$0.03

SCREWS OR PINS ARE INCLUDED  
WITH ALL HINGES AND HASPS  
CALL FOR LARGER QUANTITIES

## HINGE



**TH-231**  
BLACK  
OVERALL LENGTH: 4 3/4"  
OVERALL HEIGHT: 3 1/4"

ITEM	1+	25+	100+
TH-231	\$1.75	\$1.30	\$0.98

## ANTI-SLAM CHEST SUPPORTS

- WHEN ORDERING PLEASE SPECIFY WHAT SPRING COLOR IS NEEDED
- HOUSING IS ANTIQUE BRASS
- SPRINGS ARE COLOR CODED ACCORDING TO STRENGTH
- TO CALCULATE WHICH SPRING IS NEEDED: MULTIPLY 1/2 DEPTH OF LID X WEIGHT OF LID
- COLORS CAN BE MIXED FOR PRICE BREAK

ITEM	MOUNTING	1+	25+	100+
<b>C6012L</b>	LEFT SIDE	\$3.95	\$3.40	\$3.15
<b>C6012R</b>	RIGHT SIDE	\$3.95	\$3.40	\$3.15
<b>C6014</b>	CENTER	\$3.95	\$3.40	\$3.15

SPRING COLOR	WEIGHT LOAD
BLUE	35-40 LBS
MAROON	45-55 LBS
BLACK	55-65 LBS
YELLOW	65-95 LBS
ORANGE	95-125 LBS

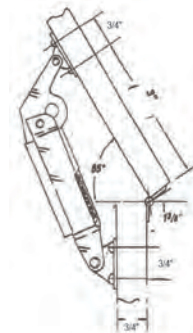

C6012L  
C6012R



C6014

## CHEST HINGES

ITEM	SOLD IN	1+	10+	50+	100+	150+
<b>CH5-BR</b>	PAIRS	\$7.00	\$6.00	-	\$5.50	-
<b>CH6-BP</b>	PAIRS	\$12.50	\$11.95	-	-	-



**CH6-BP**  
BRASS PLATED  
■ CAM ACTION



**CH5-BR**  
BROWN POWDER FINISH  
■ SPRING LOAD  
■ LID SUPPORT OVER CENTER STAY OPEN, SOFT CLOSE BEYOND CENTER

## CHEST SUPPORT HINGES

ITEM	SOLD IN	1+	6+	50+	200+
<b>LS-18</b>	PAIRS	\$35.00	\$32.00	-	-
<b>LS5-AB</b>	PAIRS	\$3.50	-	\$3.25	\$2.95
<b>LS5-BP</b>	PAIRS	\$3.50	-	\$3.25	\$2.95



**LS5-AB**  
ANTIQUÉ BRASS  
10 3/8" L X 9/16" W

**LS5-BP**  
BRASS PLATED  
10 3/8" L X 9/16" W  
■ LID STAYS  
■ HEAVY DUTY



**LS-18**  
SOLID BRASS  
18" L  
■ LID STAYS  
■ HIGH QUALITY  
■ LOCALLY MADE

CHEST HARDWARE KIT

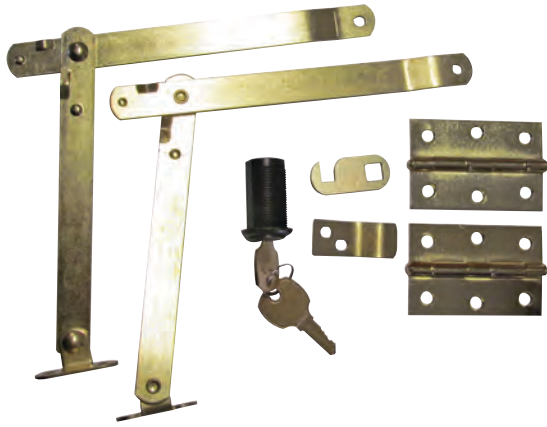

- CH-KIT**
- 1 PAIR V29A-BP HINGES
  - 1 PAIR LS5 LID SUPPORTS
  - 1 R10 LOCK WITH HOOK FINGER
  - 1 BRASS CATCH PLATE
  - ALL SCREWS INCLUDED

ITEM	1+	10+	100+
<b>CH-KIT</b>	\$10.50	\$9.25	\$7.95

LOCK CATCHES



**MC25-BR**  
BROWN  
1 3/4" W X 5/8" H  
**MC255-BL**  
BLACK  
1 3/4" W X 5/8" H  
■ BAGGED W/ SCREWS



**MAGNETIC CATCH**  
**MC23**  
3/8" DIA  
■ TAP IN ROUND



**ROLLER CATCH**  
**RC126**  
DARK ANTIQUE BRONZE



**SOLID BRASS**  
**BALL CATCH**  
**RC125**  
1/4" W X 1 1/2" H



**MC26**  
BEIGE MAGNET  
2" W X 5/8" L



**HIGH BOY MAGNET**  
**MC265-BR**  
BROWN  
1 3/4" L X 15/16" W X 7/8" H

- HEAVY DUTY CONSTRUCTION
- COMES WITH STRIKE PLATE



**DOUBLE BEND**  
**STRIKE PLATE**  
**MC27**  
5/8" W X 2" H  
■ BAGGED W/ SCREWS



**FALSE FRONT CLIP**  
**FFC12-11**



**MAGNET PUSH LATCH**  
**MC206**



**HEAVY DUTY 8LB MAGNET**  
**50760**

2" L X 1" W X 3/4" H

- 8LB
- ALL METAL
- SCREWS INCLUDED

ITEM	1+	100+	500+
<b>MC23</b>	\$1.35	\$0.99	-
<b>MC25-BR</b>	\$0.60	\$0.35	\$0.29
<b>MC255-BL</b>	\$0.60	\$0.35	\$0.29
<b>MC26</b>	\$0.95	\$0.70	\$0.55
<b>MC265-BR</b>	\$0.95	\$0.70	-
<b>MC27</b>	\$1.00	\$0.85	\$0.68
<b>RC125</b>	\$1.60	\$1.35	-
<b>RC126</b>	\$0.75	\$0.50	\$0.40
<b>MC50760</b>	\$1.75	\$1.50	-
<b>FFC12-11</b>	\$0.60	\$0.50	\$0.30
<b>MC206</b>	\$1.00	\$0.85	\$0.65

LOCKS I



**KEY HOLE PLATE**  
**EE16-PB**  
POLISHED BRASS  
**EE16-AE**  
ANTIQUÉ BRASS  
**EE16-BL**  
BLACK  
3 3/4" L X 1 3/8" H



**DESK LOCK**  
**R1-PB**  
POLISHED BRASS  
**R1-AE**  
ANTIQUÉ BRASS  
**R1-BL**  
BLACK

- LOCK CASE 1 3/4" W X 1 3/8" L X 5/16" D
- SELVEDGE 3 3/4" X 5/8"
- STRIKE PLATE 2 3/4" X 1"
- POLISHED STEEL HOUSING AND MECHANISM
- KEY PLATE SOLD SEPARATELY

ITEM	1+	10+
<b>EE16-AE</b>	\$5.00	\$4.50
<b>EE16-BL</b>	\$5.00	\$4.50
<b>EE16-PB</b>	\$5.00	\$4.50
<b>R1-PB</b>	\$10.00	\$8.50
<b>R1-AE</b>	\$10.00	\$8.50
<b>R1-BL</b>	\$10.00	\$8.50

LOCKS II



**R6-AB**  
ANTIQUE BRASS  
**R6-PB**  
POLISHED BRASS



**CAM LOCK**  
**R10-AB**  
ANTIQUE BRASS  
3/4" DIA, 1 3/16" L BARREL  
WITH STRAIGHT AND OFFSET CAM

**CAM LOCK**  
**R10-PB**  
POLISHED BRASS  
3/4" DIA, 1 3/16" L BARREL  
WITH STRAIGHT AND OFFSET CAM

**CAM LOCK**  
**R10-BL**  
BLACK  
3/4" DIA, 1 3/16" L BARREL  
WITH STRAIGHT AND OFFSET CAM

ITEM	1+	50+
<b>R6-AB</b>	\$3.00	\$1.95
<b>R6-PB</b>	\$3.00	\$1.95
<b>R10-AB</b>	\$3.95	\$3.25
<b>R10-PB</b>	\$3.95	\$3.25
<b>R10-BL</b>	\$3.95	\$3.25

MAGNETIC SAFETY LOCK



**LOCK**  
**MSL-792**

**MAGNET**  
**MSL-798**

ITEM	1+	10+
<b>MSL-798</b>	\$7.08	\$6.61
<b>MSL-792</b>	\$4.75	\$4.45

TOUCH RELEASE AIR LIFT



**SML1**  
TAN  
■ THREE PRESET POSITIONS:  
FREE ARM, FLAT BED AND  
STORAGE  
■ MOUNTS WITH 6 #8 SCREWS  
■ 19 1/4" TALL

**SML2**  
TAN  
■ THREE PRESET POSITIONS:  
FREE ARM, FLAT BED AND  
STORAGE  
■ MOUNTS WITH 6 #8 SCREWS  
■ 22 7/16" TALL

**SML-2HD**  
TAN  
■ LIKE SML2, BUT HAS STRON-  
GER CYLINDER FOR HEAVY  
MACHINES  
■ 22 7/16" TALL

ITEM	1+	4+	8+	24+
<b>SML1</b>	\$120.00	\$110.00	\$105.00	\$99.00
<b>SML2</b>	\$150.00	\$140.00	\$132.50	\$120.00
<b>SML-2HD</b>	\$165.00	\$150.00	\$140.00	—

CALL FOR LARGER QUANTITY PRICING

SERGER/MIXER LIFT



ITEM	1+	5+	10+
<b>ML-1CH</b>	\$99.95	\$89.00	\$79.95

- ML-1CH**
- PROVIDES MECHANICAL ASSISTANCE FOR HEAVY APPLIANCES SUCH AS A MIXER OR SERGER
  - FEATURES SOFT-CLOSE DAMPERS FOR SMOOTH CLOSING
  - CAN BE USED IN BOTH FRAMELESS AND FACE FRAME CABINETRY
  - SHELF (NOT INCLUDED) CAN BE CUSTOM FIT TO ANY CABINET SIZE
  - THREE SPRING SETTINGS FOR UP TO 45 LBS CAPACITY

SEWING MACHINE TREDLE



ITEM	1+	3+
<b>SMTR-2</b>	\$165.00	\$150.00

- SMTR-2**
- REPRODUCTION OF AN ORIGINAL CAST IRON SINGER TREDLE UNIT

## BLACK NYLON TWIN WHEEL CASTERS W/ HOOD



- Z11**  
2 1/8" H
- TWIN WHEEL CASTER
  - 1 1/2" WHEEL
  - SQUARE TOP PLATE 1 1/2" X 1 1/2"
  - 70 LBS CAPACITY



- Z11-A** **NEW!**  
2 1/8" H
- TWIN WHEEL CASTER WITH SOCKET
  - 1 1/2" WHEEL DIAMETER
  - STEM MOUNT 5/16" X 1 1/2"
  - 70 LB CAPACITY



- Z12**  
2 5/8" H
- TWIN WHEEL CASTER
  - 50MM WHEEL (2")
  - SQUARE TOP PLATE 1 1/2" X 1 1/2"
  - 80 LBS CAPACITY
  - WITHOUT BRAKE



- Z12-B**  
2 5/8" H
- TWIN WHEEL CASTER
  - 50MM WHEEL (2")
  - SQUARE TOP PLATE 1 1/2" X 1 1/2"
  - 80 LBS CAPACITY
  - WITH BRAKE



- Z12-A**  
2 5/8" H
- TWIN WHEEL CASTER WITH SOCKET
  - 50MM WHEEL (2")
  - STEM MOUNT 5/16" X 1 1/2"
  - 80 LBS CAPACITY
  - WITHOUT BRAKE



- Z12-HD** **NEW!**  
2 5/8" H
- HEAVY DUTY
  - 2" WHEEL DIAMETER
  - 120 LB CAPACITY
  - 1 1/2" SQ. TOP PLATE
  - WITHOUT BRAKE



- Z12B-HD** **NEW!**  
2 5/8" H
- HEAVY DUTY
  - 2" WHEEL DIAMETER
  - 120 LB CAPACITY
  - 1 1/2" SQ. TOP PLATE
  - WITH BRAKE

ITEM	10+	100+	400+	800+
<b>Z11</b>	\$0.60	\$0.50	\$0.45	\$0.40
<b>Z11-A</b>	\$0.60	\$0.50	\$0.45	-
<b>Z12</b>	\$0.70	\$0.50	\$0.45	\$0.40
<b>Z12-A</b>	\$0.75	\$0.55	\$0.50	\$0.45
<b>Z12-B</b>	\$0.95	\$0.85	\$0.80	-
<b>Z12-HD</b>	\$1.50	\$1.10	\$0.90	-
<b>Z12B-HD</b>	\$1.75	\$1.40	\$1.25	-

OTHER CASTERS AVAILABLE FOR CUSTOM REQUESTS

## POLISHED BRASS

- 2" STEM MOUNT OR PLATE MOUNT
- NO MARKING BALL
- 100 LB. RATING



**POLISHED BRASS HOOD**  
**Z14**  
2 5/8" H

- WITH SOCKET



**BLACK HOOD**  
**Z14-BL**  
2 5/8" H

- WITH SOCKET



**ANTIQUE BRASS HOOD**  
**Z14-AB**  
2 5/8" H

- WITH SOCKET



**POLISHED BRASS HOOD**  
**Z14-A**  
2 5/8" H



**ANTIQUE BRASS HOOD**  
**Z14-A-AB**  
2 5/8" H

ITEM	1+	24+	100+
<b>Z14</b>	\$2.50	\$2.30	\$2.10
<b>Z14-A</b>	\$2.50	\$2.30	\$2.10
<b>Z14-AB</b>	\$2.50	\$2.30	\$2.10
<b>Z14-A-AB</b>	\$2.50	\$2.30	\$2.10
<b>Z14-BL</b>	\$2.50	\$2.30	\$2.10

## RUBBER WHEEL CASTER

- HEAVY DUTY SWIVEL CASTER
- 2" PLATE MOUNT
- 100 LB. RATING



**HARD WHEEL**  
**Z13-HW**  
2 1/2" H



**SOFT TREAD WHEEL**  
**Z13-ST**  
2 1/2" H

ITEM	1+	24+	100+
<b>Z13-HW</b>	\$2.50	\$2.30	\$2.10
<b>Z13-ST</b>	\$2.50	\$2.30	\$2.10



## TACK ON



**A299**  
7/8" DIA  
■ STEEL NYLON CUSHION



**A300**  
1 1/16" DIA  
■ STEEL NYLON CUSHION



**PS1**  
7/8" DIA  
**PS2**  
5/8" DIA  
**PS3**  
3/4" DIA  
■ NYLON  
■ HEAVY DUTY



**PS4**  
5/8" DIA  
■ NICKEL PLATED  
■ 3 PRONG STEEL GUIDE

ITEM	100+	500+	1,000+	5,000+	10,000+
<b>A299</b>	\$0.20	\$0.17	\$130.00/M	-	-
<b>A300</b>	\$0.20	\$0.17	\$130.00/M	-	-
<b>PS1</b>	\$0.04	\$0.03	\$21.00	\$17.50/M	\$16.00/M
<b>PS2</b>	\$0.04	\$0.03	\$21.00	\$17.50/M	\$16.00/M
<b>PS3</b>	\$0.04	\$0.03	\$21.00	\$17.50/M	\$16.00/M
<b>PS4</b>	\$0.06	\$0.05	\$40.00	-	-

## THREADED



**A301**  
1" DIA



**A307**  
1" DIA  
**A308**  
1 1/4" DIA  
**A309**  
1 1/2" DIA  
■ NICKEL PLATED BASE W/ NYLON CUSHION

ITEM	1+	100+	1,000+
<b>A301</b>	\$0.25	\$0.20	\$0.13
<b>A307</b>	\$0.30	\$0.25	\$0.23
<b>A308</b>	\$0.35	\$0.30	\$0.28
<b>A309</b>	\$0.45	\$0.40	\$0.38

## SAFEGLIDES



**PS12**  
■ 3/4" FELT BASE  
■ NO DRILLING NEEDED  
■ INSTALL W/ TAP OF A HAMMER  
■ VERY THIN TUBULAR RIVET, HOLDS FAST AND PREVENTS SPLITTING  
■ GREAT FOR END GRAIN



**PS13**  
■ 1" FELT BASE  
■ USE W/ A310 OR A311 TEE NUTS



**PS14-GR**  
1" DIA  
■ PSA STICK-ON  
■ GRAY FELT PADS



**PS14**  
1" DIA  
■ WHITE FELT PADS  
■ PSA STICK-ON

ITEM	100+	500+	1,000+	7,500+
<b>PS12</b>	\$0.32	\$0.28	\$0.25	\$0.22
<b>PS13</b>	\$0.50	\$0.45	\$0.43	-
<b>PS14</b>	\$0.11	\$0.09	\$0.08	-
<b>PS14-GR</b>	\$0.11	\$0.09	\$0.08	-

PRICES LISTED ABOVE ARE PRICED PER PIECE

## TEE NUTS



**A310**  
1/4 X 20  
■ ZINC PLATED  
■ 6 PRONGS



**A313**  
1/4 - 20 X 9/16  
■ ZINC PLATED  
■ THREADED INSERT  
■ DRILL 3/8" PILOT HOLE



**A311**  
1/4 X 20  
■ ZINC PLATED  
■ 3 PRONGS



**A314**  
5/16 - 18 X 9/16  
■ ZINC PLATED  
■ THREADED INSERT  
■ DRILL 14/32" PILOT HOLE

ITEM	1+	100+	1,000+
<b>A310</b>	\$0.09	\$0.07	\$0.05
<b>A311</b>	\$0.08	\$0.06	\$0.045
<b>A313</b>	\$0.20	\$0.19	\$0.18
<b>A314</b>	\$0.30	\$0.29	\$0.27

## ADJUSTABLE NYLON SWIVEL BASE



**GLIDES**  
**A38-3**  
3" L  
**A38-6**  
6" L



**4 PRONG TEE NUT**  
**A38TN**  
3/8" DIA



**CORNER BRACKET**  
**A610**  
3/8" DIA THREAD, ZINC  
1 1/3" H X 4" L

ITEM	1+	25+	100+
<b>A38-3</b>	\$0.80	\$0.65	\$0.46
<b>A38-6</b>	\$0.90	\$0.75	\$0.57
<b>A38TN</b>	\$0.95	\$0.75	\$0.50
<b>A610</b>	\$0.75	\$0.60	\$0.45

### GLASS DOOR STRIKE WITH RUBBER SPACER



**GL523**  
1" X 1 5/8"

**Now Available  
in Black**

ITEM	1+	25+	100+
<b>GL523</b>	\$0.60	\$0.35	\$0.25

### GLASS DOOR HINGES



**GL329**  
ANTIQUE BRASS  
1/2" X 1 5/8"

ITEM	1+	25+	100+
<b>GL329</b>	\$0.90	\$0.60	\$0.40

## BEDROOM

### WARDROBE POLE SOCKETS

ITEM	SOLD IN	1+	25+	100+
<b>RH2</b>	PAIRS	\$2.75	\$2.25	\$2.00



**RH2**  
BLACK POWDER COATED  

- HEAVY DUTY
- 2 1/2" DIA, FITS A 1 1/4" DIA DOWEL

### WING FRICTION STAYS

ITEM	SOLD IN	1+	100+	250+
<b>MM10</b>	PIECES	\$0.95	\$0.85	\$0.75



**MM10**  

- KEEP MIRROR WINGS IN POSITION

### BUNK BED LADDER HOOKS



**BBH10**  
DARK ANTIQUE FINISH WITH BROWN RUBBER CAPS  
3 3/4" H X 1/2" W  

- TOP OPENING FITS OVER 3/4" TO 1" THICK WOOD

ITEM	1+	25+
<b>BBH10</b>	\$2.75	\$2.50

### BED BRACKETS



**B18-4**  
POWDER COATED BLACK  
4 3/8" W X 1 5/16" D X 2" H  

- NEW STYLE BED BRACKET
- HEAVY STEEL
- COMPLETE W/ ALL FASTENERS
- WORKS THE SAME AS B20-4

ITEM	SOLD IN	1+	10+	25+	50+	100+
<b>B18-4</b>	SETS	\$12.00	\$8.95	\$7.95	\$7.50	-
<b>B19-4</b>	SETS	\$12.95	\$9.95	\$8.95	\$8.85	-
<b>BSB-6</b>	PIECES	\$1.85	\$1.60	\$1.45	\$1.35	\$1.25



**B19-4**  
POWDER COATED BLACK  
5 1/8" W X 1 5/16" D X 2 1/4" H  

- NEW STYLE BED BRACKET
- HEAVY STEEL
- COMPLETE W/ ALL FASTENERS
- WORKS THE SAME AS B20-4



**BSB-6**  
POWDER COATED BLACK  
3 3/4" L X 1 3/4" H  

- DOVETAIL SLAT BRACKET
- HEAVY STEEL
- FITS SLATS UP TO 1 3/4" W

### BED BRACKETS II



**B15-4**  
4" L X 5/8" W  

- STEEL BED HOOK
- TWO PART BED HOOK
- SCREWS NOT INCLUDED
- 1 SET WILL DO ONE BED

**B15-6**  
6" L X 5/8" W  

- STEEL BED HOOK
- TWO PART BED HOOK
- SCREWS NOT INCLUDED
- 1 SET WILL DO ONE BED

ITEM	SOLD IN	1+	50+
<b>B15-4</b>	SETS	\$8.95	\$7.75
<b>B15-6</b>	SETS	\$10.95	\$9.95

## BED FASTENERS



- B20-4**  
CAST ALUMINUM  
4 3/8" H X 2 1/8" W
- NEEDS SAW CUT IN RAIL
  - 3 #8 SCREWS
  - 2 LAGS ON POST
  - LEFT AND RIGHT UNIVERSAL
  - SCREWS, LAGS, AND RUBBER HEAD COVER INCLUDED

ITEM	SOLD IN	1+	20+	50+
<b>B20-4</b>	SETS	\$17.50	\$13.50	\$12.50
<b>B21-4</b>	SETS	\$17.50	\$13.50	\$12.50
<b>B22-4</b>	SETS	\$19.50	\$16.50	\$15.50
<b>BSB-7</b>	SETS	\$2.25	\$2.10	\$1.95
<b>B-10-4</b>	SETS	\$13.50	\$11.50	\$10.50

SETS OF 4 PIECES



- B21-4**  
CAST ALUMINUM  
4 1/2" H X 3 3/4" W
- FLAT STYLE TO USE ON WRAP AROUND BEDS
  - SCREWS & LAGS INCLUDED



- B22-4**  
CAST ALUMINUM  
5 1/8" H X 2" D X 1 5/8" W
- HAS BOTTOM FLANGE
  - DOESN'T NEED SAW CUT
  - SCREWS & LAGS INCLUDED



- BSB-7**  
CAST ALUMINUM  
5 1/4" L X 2" H
- BED SLAT BRACKET
  - FITS SLATS UP TO 3" W



- B-10-4**  
CAST ALUMINUM  
4 5/8" H X 1 1/8" W

## FILE DRAWER CAPS

- USE FOR HANGING FILES
- FOR 1/2" OR 5/8" DRAWER SLIDE



- PLASTIC CAPS FOR FILE DRAWERS**  
**PFC-1/2**  
4' L  
**PFC-5/8**  
4' L  
BLACK PLASTIC

ITEM	SOLD IN	1+	25+	100+
<b>PFC-1/2</b>	PIECES	\$2.95	\$2.75	\$2.30
<b>PFC-5/8</b>	PIECES	\$2.95	\$2.75	\$2.30

## FILE BAR CLIP AND BAR



- 464ZN**  
1/2"  
**580ZN**  
5/8"



- 1296ZN**  
3MM THICK X 1/2" TALL  
4' LENGTH

ITEM	1+	100+
<b>464ZN</b>	\$0.40	\$0.35
<b>580ZN</b>	\$0.40	\$0.35

ITEM	SOLD IN	1+	10+
<b>1296ZN</b>	PIECES	\$5.95	\$4.95

## TABLE TOP LIFT



- LT8700**  
BLACK PAINTED LIFT MECHANISM
- AMERICAN MADE SOLID STEEL CONSTRUCTION
  - WILL BRING A COFFEE TABLE TO REGULAR TABLE HEIGHT
  - COUNTER WEIGHT MAY BE NEEDED
  - NEEDS TO BE 16 1/2" INSIDE DEPTH
  - MINIMUM SKIRT HEIGHT 4 1/4"

ITEM	1+	10+	50+
<b>LT8700</b>	\$39.95	\$36.95	\$33.95

## WOODEN TABLE SLIDES

- WE WILL NOW STOCK WOODEN TABLE SLIDES WITH METAL GEARS
- PRICE INCLUDES 1 RIGHT HAND AND 1 LEFT HAND SLIDE



### 3 Section Slides with Gears

ITEM	Length	Opening	1 PC	10 PC
TS-2625	26"	25 1/2"	\$39.95	\$30.80
TS-3837	38"	37 1/2"	\$45.90	\$35.70
TS-4443	44"	43"	\$49.95	\$38.85
TS-4847	48"	47 1/2"	\$51.30	\$39.90
TS-5049	50"	49"	\$54.00	\$42.00

### 5 Section Slides with Double Gears

ITEM	Length	Opening	1 PC	10 PC
TS-2437	24"	37 1/2"	\$72.00	\$56.00
TS-2838	28"	38"	\$78.00	\$60.90
TS-3650	36"	50"	\$84.60	\$65.80

## BED BOLT AND BOLT WRENCH



**JGW1**  
■ BOLT WRENCH



**JG416**

- STEEL BED BOLT
- NUT INCLUDED
- OVERALL LENGTH: 6 1/4"
- HEAD 7/16" SQUARE

ITEM	1+	50+	100+
JG416	\$2.00	\$1.70	\$1.50
JGW1	\$3.95	\$3.50	-

## HIGH CHAIR

- COMES AS A SET FOR ATTACHING ONE HIGH CHAIR TRAY
- LONG PIECE ATTACHES TO OUTSIDE OF THE ARM
- SHORT PIECE ATTACHES TO THE UNDERSIDE OF THE TRAY
- SPRING LOADED CLAMP ALLOWS THE POSITION OF THE TRAY TO BE ADJUSTED THEN LOCKED INTO PLACE



### SLIDING TRAY HARDWARE

#### HC12

ARM PIECE: 6" L X 5/8" W X 7/8" D  
TRAY PIECE: 3 5/16" L X 1" W X 15 15/16" D

ITEM	SOLD IN	1+	20+
HC12	SETS	\$7.95	\$5.95

## HIGH CHAIR TRAY



### HIGH CHAIR TRAY

#### HC13

SOLID OAK SCOOPED  
20 1/2" W X 11 3/4" D

ITEM	1+	6+
HC13	\$28.00	\$24.00

## TV SWIVELS



**LZ3**  
3" DIA  
**LZ4**  
4" DIA  
**LZ6**  
6" DIA

■ LAZY SUSAN BEARINGS



**LZ-BF**  
7" X 7" FLAT  
**LZ-BTL**  
7" X 7" 3° TILTED

■ HEAVY DUTY BAR STOOL  
AND ROCKER SWIVEL

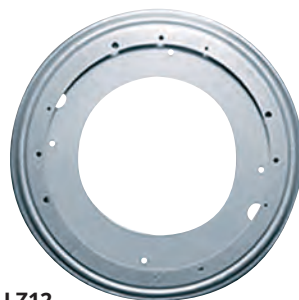

**LZ12**  
12" DIA

■ BALL BEARING SWIVEL

ITEM	1+	25+	50+
<b>LZ3</b>	\$1.60	\$1.20	\$0.95
<b>LZ4</b>	\$1.70	\$1.30	\$1.10
<b>LZ6</b>	\$2.50	\$2.15	\$1.95
<b>LZ12</b>	\$7.75	\$6.00	\$4.95
<b>LZ-BF</b>	\$8.00	\$6.95	\$5.75
<b>LZ-BTL</b>	\$8.00	\$6.95	\$5.75

## ICE BOX HARDWARE

- SOLID BRASS
- HAND POLISHED & LAQUERED FINISH



**NAME PLATE**  
**T204**  
3 1/2" L X 1 1/2" W



**T101**  
3 1/2" L X 1 7/8" W  
■ 3/8" OFFSET



**T103-L**  
■ LEFT HAND  
■ 3/8" OFFSET  
■ BASE 2 1/4" H  
■ LEVER 3 1/4" L



**T102-R**  
■ RIGHT HAND  
■ 3/8" OFFSET  
■ BASE 2 1/4" H  
■ LEVER 3 1/4" L

ITEM	1+	100+
<b>T101</b>	\$5.25	\$4.35
<b>T102-R</b>	\$8.95	\$7.45
<b>T103-L</b>	\$8.95	\$7.45
<b>T204</b>	\$3.50	-

## TABLE LOCKS



**WD12**  
■ CAM ACTION LATCH  
■ YELLOW ZINC  
■ KEEPS LEAVES AND TOP TOGETHER



**WD50**  
■ SPRINGLOAD CAMLOCK  
■ HOLDS TABLE LEAVES TOGETHER

ITEM	10+	100+	1000+
<b>WD12</b>	\$1.70	\$0.90	-
<b>WD50</b>	\$1.50	\$0.99	\$0.85

## FOLDING LEG BRACKETS

- FOLDING LEG BRACKETS FOR LONG EXTENSION TABLES FOR EXTRA SUPPORT
- FOLD UP UNDERNEATH WHEN NOT IN USE, SPRING ACTIVATED TRIGGER RELEASE
- POSITIVE LOCKING IN OPEN AND CLOSED POSITION
- ACCOMMODATES 1 1/2" SQ LEG
- DARK ANTIQUE BRONZE COLOR



**CTLB1**



**CTLB2**

ITEM	10+	100+	1000+
<b>CTLB1</b>	\$3.50	\$2.75	\$2.40
<b>CTLB2</b>	\$3.50	\$2.75	\$2.40

**TABLE HARDWARE**



**TABLE LEG BRACE  
TBL1**  
3" L X 1 1/2" W



**TABLE LEG BRACE  
TBL2**  
4 1/2" L X 2" W



**DOUBLE HOLE LEG BRACE  
TBL3**  
4 3/4" L X 3" H

- EXTRA HEAVY DUTY 14 GA.
- ZINC



**TABLE TOP EVENER  
WD15**  
1 1/2" L X 3/4" W

- 16 GA. RIBBED STEEL



**TABLE TOP FASTENERS  
WD21**  
3/4" W

ITEM	1+	100+	1000+
<b>TBL1</b>	\$0.80	\$0.60	-
<b>TBL2</b>	\$0.90	\$0.70	-
<b>TBL3</b>	\$1.25	\$0.85	-
<b>WD15</b>	\$0.16	\$0.14	\$0.12
<b>WD21</b>	\$0.16	\$0.14	\$0.12

**TABLE LEAF HARDWARE**



**TABLE LEAF PINS  
WD10**  
1 1/4" L X 3/8" DIA

ITEM	1+	100+	1,000+	15,000+
<b>WD10</b>	\$0.08	\$0.07	\$55.00/M	48.00/M



**DROP TABLE LEAF HINGE  
SH3**  
1 1/4" W REGULAR PLAIN STEEL  
3" L X 1 1/2" W

**SH4**  
1 1/2" HEAVY DUTY YELLOW  
3" L X 1 1/2" W

- STEEL
- ZINC FINISH



ITEM	1+	100+	500+	1,000+
<b>SH3</b>	\$0.75	\$0.70	\$0.65	\$0.55
<b>SH4</b>	\$0.75	\$0.70	\$0.65	\$0.55



**TABLE LEAF OR BENCH SUPPORTS  
DLS6  
DLS8  
DLS10  
DLS12**

- YELLOW ZINC PLATED

ITEM	SIZE	1+	100+
<b>DLS6</b>	6"	\$2.80	\$2.45
<b>DLS8</b>	8"	\$2.95	\$2.50
<b>DLS10</b>	10"	\$3.25	\$2.80
<b>DLS12</b>	12"	\$3.50	\$2.95



**TABLE LEAF FLAP HINGE  
TLH-515**  
STEEL, YELLOW CHROMATE  
642.70515  
7 1/2" L X 2 3/8" W

ITEM	SIZE	1+	100+
<b>TLH-515</b>	7 1/2"	\$5.95	\$5.10

NOTE: Hinge is under constant spring tension. Keep fingers clear when operating.

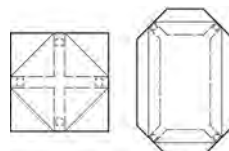

NOTE: Table leaves are held securely under table. Rotate leafs up (180°) and hinges automatically lock leafs into horizontal position. Flap hinge is designed for relatively light duty applications. Flap should not exceed 8" in depth, please conduct your own test. Häfele cannot specify a weight rating.

**METAL TABLE LEGS**



**UB Series**  
Color: Flat Black



**X Series**  
Color: Flat Black



**RHP Series**  
Round Hairpin  
Color: Flat Black



**SHP Series**  
Square Hairpin  
Color: Black Wrinkle



**TTHP Series**  
Square Twist Hairpin  
Color: Black Wrinkle

ITEM	DIMENSIONS	MATERIAL	DESCRIPTION	SET OF 2
<b>UB-42628</b>	26" W X 28" H	2 X 4	DINING	\$209.51
<b>UB-32628</b>	26" W X 28" H	1½ X 3	DINING	\$171.34
<b>UB-31816</b>	18" W X 16" H	1½ X 3	COFFEE	\$110.61
<b>UB-21216</b>	12" W X 16" H	1 X 2	BENCH	\$83.25
<b>UB-21224</b>	12" W X 24" H			\$99.81
<b>UB-21228</b>	12" W X 28" H			\$99.81
<b>UB-21234</b>	12" W X 34"			\$112.44
<b>X-2628</b>	26" W X 28" H	2" SQ.	DINING	\$125.09
<b>X-1816</b>	18" W X 16" H	2" SQ.	COFFEE	\$103.36
<b>X-1216</b>	12" W X 16" H	2" SQ.	BENCH	\$97.50

ITEM	HEIGHT	MATERIAL	DESCRIPTION	SET OF 4
<b>RHP-16</b>	16" H	3/8 RD.	COFFEE	\$66.45
<b>RHP-24</b>	24" H	3/8 RD.	END TABLE	\$78.29
<b>RHP-28</b>	28" H	1/2 RD.	DINING	\$108.79
<b>RHP-34</b>	34" H	1/2 RD.	COUNTER HT	\$118.29
<b>SHP-16</b>	16" H	3/8 RD.	COFFEE	\$66.83
<b>SHP-24</b>	24" H	3/8 RD.	END TABLE	\$82.04
<b>SHP-28</b>	28" H	1/2 RD.	DINING	\$20.66
<b>SHP-34</b>	34" H	1/2 RD.	COUNTER HT	\$128.29
<b>TTHP-16</b>	16" H	3/8 RD.	COFFEE	\$87.45
<b>TTHP-24</b>	24" H	3/8 RD.	END TABLE	\$102.04
<b>TTHP-28</b>	28" H	1/2 RD.	DINING	\$123.29
<b>TTHP-34</b>	34" H	1/2 RD.	COUNTER HT	\$138.29

CALL FOR QUANTITY PRICING

**More Options  
Coming in Spring!**

**SHELF BRACKETS**



**HDSB Series**  
Color: Black Wrinkle



**SB Series**  
Color: Black Wrinkle



**SBF Series**  
Color: Flat Black

ITEM	SIZE	MATERIAL	1+
<b>HDSB-66</b>	6 X 6	1/4 X 3/4	\$16.38
<b>HDSB-68</b>	6 X 8	1/4 X 3/4	\$17.49
<b>HDSB-810</b>	8 X 10	1/4 X 3/4	\$20.15
<b>SB-66</b>	6 X 6	1/8 X 1	\$12.29
<b>SB-68</b>	6 X 8	1/8 X 1	\$12.94
<b>SB-810</b>	8 X 10	1/8 X 1	\$14.63
<b>SBF-65</b>	6-1/2 X 6-1/2	1/8	\$12.03
<b>SBF-9</b>	9 X 9	1/8	\$14.89
<b>SBF-12</b>	12 X 12	1/8	\$18.66

## SHELF STANDARDS & SUPPORTS



**STN1**

- BRONZE
- SNAPS FIRMLY INTO HORIZONTAL SLOTS
- MEET ANSI/BHMA STANDARDS
- GRADE 3



**STN4** ■ FRUITWOOD

- NUMBERED FOR PERFECT ALIGNMENT
- REPOSITIONING EVERY 1/2"
- SURFACE OR RECESS MOUNT

ITEM	LENGTH	PIECES/BOX	1 +	100+	1,000+
<b>STN1</b>	----	----	----	\$17.00/C	\$150.00/M
<b>STN4</b>	4'	20	\$2.50	\$2.25	\$2.05
<b>STN6</b>	6'	20	\$3.50	\$3.25	\$3.05

### 1/4" SPOON SUPPORT



**MM19**  
BRASS  
1/4"



**MM19-AC**  
ANTIQUÉ COPPER  
1/4"



**MM19-BL**  
BLACK  
1/4"



**MM19-N**  
NICKEL  
1/4"

ITEM	100+	1,000+	5,000+
<b>MM19</b>	\$5.00/C	\$24.50/M	\$22.50/M
<b>MM19-BL</b>	\$5.00/C	\$24.50/M	\$22.50/M
<b>MM19-AC</b>	\$5.00/C	\$24.50/M	\$22.50/M
<b>MM19-N</b>	\$5.00/C	\$24.50/M	\$22.50/M

### 5MM SPOON SUPPORT



**MM19A**  
BRASS  
5MM



**MM19A-AC**  
ANTIQUÉ COPPER  
5MM



**MM19A-BL**  
BLACK  
5MM



**MM19A-N**  
NICKEL  
5MM

ITEM	100+	1,000+	5,000+
<b>MM19A</b>	\$5.00/C	\$23.00/M	\$19.00/M
<b>MM19A-BL</b>	\$5.00/C	\$23.00/M	\$19.00/M
<b>MM19A-AC</b>	\$5.00/C	\$23.00/M	\$19.00/M
<b>MM19A-N</b>	\$5.00/C	\$23.00/M	\$19.00/M

### 1/4" ANGLE SUPPORT



**MM18**  
BRASS  
1/4"



**MM18-AC**  
ANTIQUÉ COPPER  
1/4"

ITEM	100+	1,000+	4,000+
<b>MM18</b>	\$8.00/C	\$62.00/M	\$59.00/M
<b>MM18-AC</b>	\$8.00/C	\$62.00/M	\$59.00/M

### 5MM ANGLE SUPPORT



**MM18A**  
BRASS  
5MM



**MM18A-AC**  
ANTIQUÉ COPPER  
5MM



**MM18A-N**  
NICKEL  
5MM



**MM18A-BL**  
BLACK  
5MM

ITEM	100+	1,000+	4,000+
<b>MM18A</b>	\$8.00/C	\$62.00/M	\$59.00/M
<b>MM18A-AC</b>	\$8.00/C	\$62.00/M	\$59.00/M
<b>MM18A-N</b>	\$10.00/C	\$78.00/M	\$75.00/M
<b>MM18A-BL</b>	\$10.00/C	\$78.00/M	\$75.00/M

### 1/4" ANGLE SUPPORT WITH BROWN RUBBER



**MM18R**  
BRASS  
1/4"



**MM18R-AC**  
ANTIQUÉ COPPER  
1/4"

ITEM	100+	1,000+	4,000+
<b>MM18R</b>	\$10.00/C	\$82.00/M	\$71.50/M
<b>MM18R-AC</b>	\$10.00/C	\$82.00/M	\$71.50/M

### 5MM ANGLE SUPPORT WITH BROWN RUBBER



**MM18RA**  
BRASS  
5MM



**MM18RA-AC**  
ANTIQUÉ COPPER  
5MM

ITEM	100+	1,000+	4,000+
<b>MM18RA</b>	\$10.00/C	\$82.00/M	\$71.50/M
<b>MM18RA-AC</b>	\$10.00/C	\$82.00/M	\$71.50/M

### CORNER BRACES



**EB1**  
1" X 3/4" WIDE AT LEG



**EB2**  
1 1/2" CORNER BRACES  
■ ANTIQUE BRASS

ITEM	100+	1,000+
<b>EB1</b>	\$0.15	\$105.00/M
<b>EB2</b>	\$0.25	\$180.00/M



## MIRROR MOUNTS OR GLASS RETAINERS



### PMR1

- CLEAR PLASTIC MIRROR MOUNTS
- RETAINER FOR 1/8"



### PGR1 FLUSH PGR2

- 3/16" OFFSET
- BROWN PLASTIC

ITEM	1000+
PGR1	\$28.50/M
PGR2	\$28.50/M
PMR1	\$28.50/M



### M12

- BRASS PLATED STEEL MIRROR MOUNTING FRICTION HINGES
- FRICTION ADJUSTED BY SCREW TIGHTENING
- 2" PIN
- 3/4" X 1 1/4" BRACKETS

ITEM	SOLD IN	1+
M12	PAIRS	\$4.50

- INSTALLS EASILY AND QUICKLY
- RETAINS GLASS WHILE ELIMINATING RATTLE
- NO STAPLES OR GLUE REQUIRED
- FITS GROOVE SIZES FROM .125 THROUGH .130



- GRF1**  
CLEAR
- GRF2**  
BROWN
- GRF3**  
FRUITWOOD  
(SHOWN)

## MIRROR OR GLASS RUBBER

ITEM	PER FOOT	1 ROLL	5 ROLLS
GRF1	\$0.20	\$49.50	\$45.00
GRF2	\$0.20	\$49.50	\$45.00
GRF3	\$0.20	\$49.50	\$45.00

SOLD IN 500 FT. ROLLS

## SPACEBALLS & GLASS RETAINERS

- SPACEBALLS - THE MONEY SAVER
- NON-BLEEDING - BLACK
- STOP PANEL RATTLE CENTERS SOLID PANELS
- COMPRESSES IF PANELS EXPAND (.26" DIAMETER)
- HELPS ELIMINATE CRACKING PANELS
- WILL CUT OUT MOST MAJOR CALL-BACKS

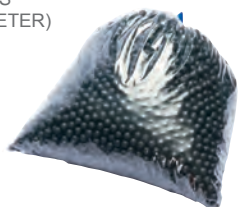

SB20

ITEM	SOLD IN	1+	5+	10+
SB20	BAGS	\$69.00	\$64.50	\$59.50

5,000 PIECES PER BAG  
BULK BAG OF 100,000 PC IS \$10.99/M

## EURO DOOR STOP

- FOR INSET CABINET DOORS
- ADJUSTABLE



EDS-WH



EDS-BR

ITEM	1+
EDS-BR	\$13.45/C
EDS-WH	\$13.45/C

SOLD IN BOXES  
100 PIECES PER BOX

## CLEAR RUBBER BUMPERS

- SELF ADHESIVE
- DOME SHAPED
- DOORS & DRAWERS, ETC.

ITEM	1,000+	5,000+
ARB-5	\$25.00/M	\$21.50/M



ARB-5  
3/8" DIA

## SELF ADHESIVE FELT DOTS

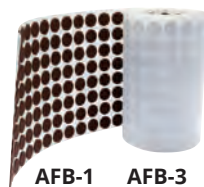

- AFB-1**  
3/8"  
BROWN
- AFB-2**  
1/2"  
BROWN
- AFB-3**  
3/4"  
BROWN

ITEM	1,000+	1 ROLL+	3 ROLLS+
AFB-1	\$6.95/M	\$4.95/M	\$4.50/M
AFB-2	\$10.95/M	\$8.25/M	\$7.50/M
AFB-3	\$16.00/M	\$14.50/M	\$13.50/M

5,000 PIECES PER ROLL

**MIRROR MOUNTS**

ITEM	SOLD IN	1+	6+	24+
<b>MS48</b>	PAIRS	\$8.00	\$6.95	\$6.75
<b>MS60</b>	PAIRS	\$9.00	\$7.75	\$7.75

- MIRROR MOUNTS
- HEAVY DUTY SLOTTED SUPPORTS
- GALVANIZED STEEL

**MS48 - 4' long**  
**MS60 - 5' long**



**DESK FASTENER**

- FIGURE 8 DESK TOP FASTENERS
- STAT BRONZE

ITEM	100+	1,000+
<b>DF1</b>	\$10.00	\$75.00



**DF1**  
5/16" L, SMALL END 1/8" W,  
LONG END 3/4" W

**FLUSH FIXTURE CONNECTORS**

- PLAIN STEEL TAPER CONNECTORS FOR CONNECTING FLUSH FIXTURES, INVISIBLE JOINTS, BEDS, HALL TREES, WALL CAB, ETC
- LOCKS TIGHT WITH PRESSURE

ITEM	1+	100+
<b>K2020</b>	\$0.89	\$0.75



**K2020**  
1/4" THICK X 5/8" W X 4" L

**ANTI TIPPING RESTRAINT**

- PREVENTS LARGE FURNITURE PIECES FROM TIPPING OVER

ITEM	1+	50+	100+
<b>XANTITIP</b>	\$0.75	\$0.70	\$0.60
<b>WARNING LABEL</b>	\$0.25	\$0.23	\$0.20



**XANTITIP**



**WARNING LABEL**  
2.7" X 2"

**FLAT/MENDING PLATES**



**V9317**  
4" H X 7/8" W



**V9315**  
3" H X 3/4" W



**V9314**  
2 3/16" H X 5/8" W



**V9313**  
2" H X 5/8" W

ITEM	BORE DRILL C/C	PER 100	PER 1,000
<b>V103841</b>	5/8"	\$12.75	\$115.00
<b>V9313</b>	32MM	\$18.00	\$165.00
<b>V9314</b>	32MM STAGGERED 2 SETS	\$16.00	\$148.50
<b>V9315</b>	1 5/8" STAGGERED 2 SETS	\$36.00	\$300.50
<b>V9317</b>	2 3/8" STAGGERED 2 SETS	\$40.00	\$340.00
<b>V9005</b>	32MM HORIZONTAL / VERTICAL SLOTTED	\$26.00	\$215.00



**V103841**  
1 5/16" H  
■ FIGURE 8



**V9005**  
2" H X 1 9/16" W

**MISC. FASTENERS**



**SAWTOOTH HANGERS**  
**ST1**  
1 1/2" L  
**ST2**  
2 1/2" L



**MH1**  
7/16" W X 1 5/8" L  
■ HANGER  
■ ZINC COLOR  
■ TWO HOLE FLAT

ITEM	100+	1000+
<b>MH1</b>	\$6.00/C	\$33.00/M
<b>ST1</b>	\$5.00/C	\$32.50/M
<b>ST2</b>	\$5.50/C	\$35.00/M

**G\*GRASS®**

## DYNAPRO 16 UNDERMOUNT DRAWER SLIDE FOR 5/8" MATERIAL



ITEM	DESCRIPTION	BOX QTY.	1+ PR	25+ PR	100+ PR
<b>DYNA-21-2D</b>	(21") 2D ADJ.	5	\$15.92	\$14.74	\$14.15
<b>DYNA-18-2D</b>	(18") 2D ADJ.	5	\$15.42	\$14.28	\$13.70
<b>DYNA-15-2D</b>	(15") 2D ADJ.	5	\$16.24	\$15.04	\$14.44
<b>DYNA-12-2D</b>	(12") 2D ADJ.	5	\$16.24	\$15.04	\$14.44
<b>DYNA-9-2D</b>	(9") 2D ADJ.	5	\$19.10	\$17.69	\$16.98

## DYNAPRO 16MM 3D SLIDES FOR 5/8" MATERIAL

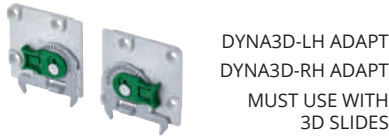

ITEM	DESCRIPTION	BOX QTY.	1+ PR	25+ PR	100+ PR
<b>DYNA-21-3D</b>	(21") 3D ADJ.	5	\$21.80	\$20.19	\$19.38
<b>DYNA-18-3D</b>	(18") 3D ADJ.	5	\$21.45	\$19.86	\$19.07
<b>DYNA-15-3D</b>	(15") 3D ADJ.	5	\$21.05	\$19.49	\$18.71

ITEM	DESCRIPTION	BOX QTY.	BROKEN BOX	FULL BOX
<b>DYNA3D-LH ADAPT</b>	TILT ADJ. ADAPTER LEFT	200	\$0.56	\$0.48
<b>DYNA3D-RH ADAPT</b>	TILT ADJ. ADAPTER RIGHT	200	\$0.56	\$0.48

## DYNAPRO 16 HEAVY DUTY UNDERMOUNT DRAWER SLIDE



ITEM	DESCRIPTION	BOX QTY.	BROKEN BOX	FULL BOX
<b>DYNAHD-30-3D</b>	(30") 3D ADJ.	4	\$57.04	\$52.66
<b>DYNAHD-27-3D</b>	(27") 3D ADJ.	4	\$50.15	\$46.30
<b>DYNAHD-24-3D</b>	(24") 3D ADJ.	5	\$40.60	\$37.48
<b>DYNAHD-21-3D</b>	(21") 3D ADJ.	5	\$35.19	\$32.48
<b>DYNAHD-18-3D</b>	(18") 3D ADJ.	5	\$34.41	\$31.76

## FRONT LOCKING DEVICE

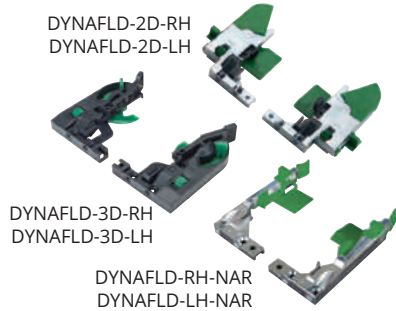

ITEM	DESCRIPTION	BOX QTY.	BROKEN BOX	FULL BOX
<b>DYNAFLD-2D-LH</b>	2D FRT. LOCK DEVICE LEFT	200	\$1.60	\$1.43
<b>DYNAFLD-2D-RH</b>	2D FRT. LOCK DEVICE RIGHT	200	\$1.60	\$1.43
<b>DYNAFLD-3D-LH</b>	3D FRT. LOCK DEVICE LEFT	200	\$0.99	\$0.89
<b>DYNAFLD-3D-RH</b>	3D FRT. LOCK DEVICE RIGHT	200	\$0.99	\$0.89
<b>DYNAFLD-1D-LH</b>	1D FRT. LOCK DEVICE LEFT	200	\$0.75	\$0.67
<b>DYNAFLD-1D-RH</b>	1D FRT. LOCK DEVICE RIGHT	200	\$0.75	\$0.67
<b>DYNAFLD-RH-NAR</b>	NARROW FRT LOCK DEVICE LEFT	200	\$1.05	\$0.99
<b>DYNAFLD-LH-NAR</b>	NARROW FRT LOCK DEVICE RIGHT	200	\$1.05	\$0.99

## DYNAPRO ACCESSORIES

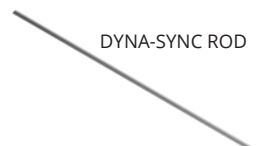
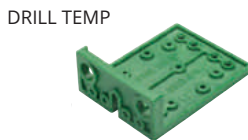

ITEM	DESCRIPTION	BOX QTY.	BROKEN BOX	FULL BOX
<b>DYNA-DEPTH ADJ</b>	DEPTH ADJUSTMENT	5	\$2.79	\$2.39
<b>DRILL TEMP</b>	DRILLING TEMPLATE	1	\$25.89	-
<b>UNIV-7950</b>	UNIVERSAL REAR MOUNTING BRACKET	300	\$0.39	\$0.34
<b>UNIV-7951</b>	NARROW REAR MOUNTING BRACKET	300	\$0.87	\$0.74
<b>DYNA-9-BRKT</b>	REAR MOUNTING BRACKET FOR 9" SLIDE	5	\$3.95	\$3.38
<b>INSET-13901</b>	INSET BRACKET FOR DYNAPRO	50	\$5.77	\$4.94
<b>DYNA-PUSH OPEN</b>	TIPMATIC SOFT CLOSE MECH.	1	-	\$40.53
<b>DYNA-SYNC ROD</b>	TIPMATIC SYNC. ROD	1	-	\$5.02

## MAXCESS 16 FULL ACCESS UNDERMOUNT SLIDE, 5 PACK

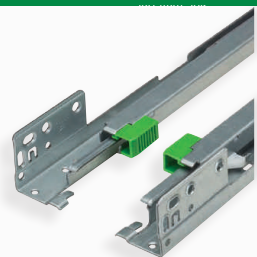

ITEM	DESCRIPTION	BOX QTY.	1+ PR	25+ PR
<b>MAX-21</b>	16 533MM (21")	5	\$11.19	\$9.59
<b>MAX-18</b>	16 457MM (18")	5	\$10.60	\$9.08
<b>MAX-15</b>	16 381MM (15")	5	\$9.86	\$8.45
<b>MAX-12</b>	16 305MM (12")	5	\$9.27	\$7.94
<b>MAX-9</b>	16 229MM (9")	5	\$9.16	\$7.85

## MAXCESS 16 FULL ACCESS UNDERMOUNT SLIDE, 200 BULK PACK



ITEM	DESCRIPTION	BOX QTY.	FULL BOX
<b>MAX-21-B</b>	16 533MM (21")	200	\$8.59
<b>MAX-18-B</b>	16 457MM (18")	200	\$8.12
<b>MAX-15-B</b>	16 381MM (15")	200	\$7.57

## FRONT LOCKING DEVICE



MAX FLD LH  
MAX FLD RH

ITEM	DESCRIPTION	BOX QTY.	BROKEN BOX	FULL BOX
<b>MAX-FLD-LH</b>	7523 FLANGED FRT. LOCK DEVICE, LEFT	200	\$0.53	\$0.46
<b>MAX-FLD-RH</b>	7523 FLANGED FRT. LOCK DEVICE, RIGHT	200	\$0.53	\$0.46
<b>UNIV-7950.VE300</b>	UNIVERSAL REAR MOUNT BRACKET	300	\$0.39	\$0.34
<b>MAX-EURO-BKT</b>	7503 EURO SIDE MOUNT BRACKET	200	\$0.38	\$0.32



UNIV-7950.VE300



MAX-EURO-BKT

## KINVARO T-65 SET

ITEM	DESCRIPTION	BOX QTY.	1+ PR	5+ PR
<b>T-65</b>	FLAP LIFTER SET, SOFT-CLOSE	1	\$24.81	\$21.26

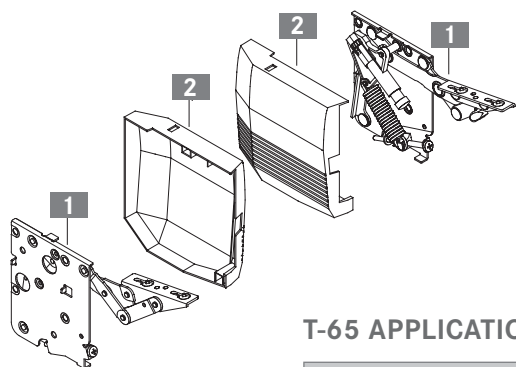

**Kinvaro T-65 set includes:**

- 1** Fitting on the right side without damper and on the left with damper (1x)
- 2** Cover caps on right and left (1x)
- Springs, yellow, loose (2x)
- Paper template (1x)
- Installation instructions (1x)

### T-65 APPLICATION RANGE

Cabinet height	Flap weight incl. handle lbs.(kg)		
	Spring on one side yellow	Spring on both sides yellow	Spring on both sides black
9 27/32" (250)	2.0 - 4.6 (0.9 - 2.1)	4.0 - 9.3 (1.8 - 4.2)	5.3 - 16.3 (2.4 - 7.4)
11 13/16" (300)	1.5 - 3.7 (0.7 - 1.7)	3.1 - 7.5 (1.4 - 3.4)	4.4 - 13.9 (2.0 - 6.3)
13 25/32" (350)	-	2.2 - 6.4 (1.0 - 2.9)	3.7 - 11.9 (1.7 - 5.4)
15 3/4" (400)	-	1.8 - 5.5 (0.8 - 2.5)	3.3 - 10.4 (1.5 - 4.7)
17 23/32" (450)	-	1.5 - 4.9 (0.7 - 2.2)	2.9 - 9.3 (1.3 - 4.2)
19 11/16" (500)	-	1.3 - 4.4 (0.6 - 2.0)	2.9 - 8.6 (1.3 - 3.9)
21 21/32" (550)	-	-	2.9 - 7.5 (1.3 - 3.4)
23 5/8" (600)	-	-	2.9 - 6.8 (1.3 - 3.1)

## TEC SELF-CLOSE DOWELLED



ITEM	DESCRIPTION	BOX QTY.	BROKEN BOX	FULL BOX
<b>TEC 02905</b>	SELF-CLOSE, 1/2" WRAP MOUNT	300	\$0.99	\$0.89

## TEC SELF-CLOSE SCREW-ON



ITEM	DESCRIPTION	BOX QTY.	BROKEN BOX	FULL BOX
<b>TEC 04396</b>	SELF-CLOSE, 1/4" WRAP MOUNT	300	\$1.04	\$0.93
<b>TEC 04399</b>	SELF-CLOSE, 1/2" WRAP MOUNT	300	\$0.97	\$0.86
<b>TEC 04400</b>	SELF-CLOSE, 3/4" WRAP MOUNT	300	\$1.04	\$0.93
<b>TEC 04401</b>	SELF-CLOSE, 1" WRAP MOUNT	300	\$1.06	\$0.95
<b>TEC 04493</b>	SELF-CLOSE, 1 1/4" WRAP MOUNT	300	\$1.04	\$0.93
<b>TEC 02284</b>	SELF-CLOSE, 1 7/16" FACE MOUNT	300	\$1.65	\$1.48

## TEC SOFT-CLOSE DOWELLED



ITEM	DESCRIPTION	BOX QTY.	BROKEN BOX	FULL BOX
<b>TEC 02870A</b>	SOFT-CLOSE, 1/2" WRAP MOUNT	300	\$2.34	\$2.09
<b>TEC 02910A</b>	SOFT-CLOSE, 1 1/4" WRAP MOUNT	300	\$2.37	\$2.11

## TEC SOFT-CLOSE SCREW-ON



ITEM	DESCRIPTION	BOX QTY.	BROKEN BOX	FULL BOX
<b>TEC 04429A</b>	SOFT-CLOSE, 1/4" WRAP MOUNT	300	\$2.28	\$2.04
<b>TEC 04431A</b>	SOFT-CLOSE, 1/2" WRAP MOUNT	300	\$2.24	\$2.00
<b>TEC 04432A</b>	SOFT-CLOSE, 3/4" WRAP MOUNT	300	\$2.28	\$2.04
<b>TEC 04441A</b>	SOFT-CLOSE, 1" WRAP MOUNT	300	\$2.34	\$2.09
<b>TEC 04547A</b>	SOFT-CLOSE, 1 1/4" WRAP MOUNT	300	\$2.28	\$2.04
<b>TEC 04549A</b>	SOFT-CLOSE, 1 1/2" WRAP MOUNT	300	\$2.34	\$2.09

## TEC ANGLE REDUCTION CLIP

ITEM	DESCRIPTION	BOX QTY.	BROKEN BOX	FULL BOX
<b>TEC-CLIP</b>	TEC OPENING ANGLE REDUCTION TO 85°	100	\$0.91	\$0.81

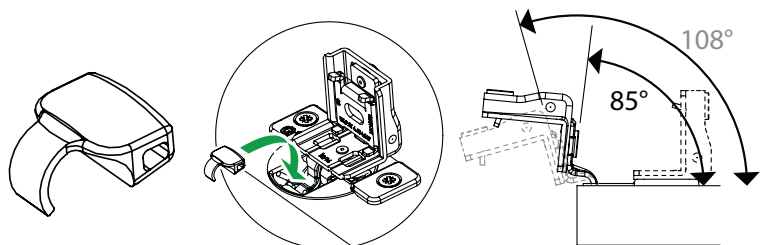

## TIOMOS 110° IMPRESSO HINGE



ITEM	MFG #	HINGE TYPE	HINGE CRANK	BOX QTY.	BROKEN BOX	FULL BOX
<b>TIO-414</b>	<b>F017139414228</b>	SOFT-CLOSE	00	150	\$4.05	\$3.61
<b>TIO-415</b>	<b>F017139415228</b>	SOFT-CLOSE	03	150	\$4.05	\$3.61
<b>TIO-416</b>	<b>F017139416228</b>	SOFT-CLOSE	9.5	150	\$4.20	\$3.75
<b>TIO-417</b>	<b>F017139417228</b>	SOFT-CLOSE	19	150	\$4.33	\$3.86
<b>TIO-385</b>	<b>F034139385228</b>	SELF-CLOSE	00	150	\$2.11	\$1.89
<b>TIO-386</b>	<b>F034139386228</b>	SELF-CLOSE	03	150	\$2.11	\$1.89
<b>TIO-387</b>	<b>F034139387228</b>	SELF-CLOSE	9.5	150	\$2.32	\$2.08
<b>TIO-388</b>	<b>F034139388228</b>	SELF-CLOSE	19	150	\$2.44	\$2.18
<b>TIO-443</b>	<b>F035139443228</b>	FREE SWING	03	150	\$2.94	\$2.63
<b>TIO-444</b>	<b>F035139444228</b>	FREE SWING	9.5	150	\$3.25	\$2.90

## TIOMOS 110° DOWELLED HINGE



ITEM	MFG #	HINGE TYPE	HINGE CRANK	BOX QTY.	BROKEN BOX	FULL BOX
<b>TIO-523</b>	<b>F028138523228</b>	SOFT-CLOSE	00	150	\$3.22	\$2.88
<b>TIO-524</b>	<b>F028138524228</b>	SOFT-CLOSE	03	150	\$3.22	\$2.88
<b>TIO-525</b>	<b>F028138525228</b>	SOFT-CLOSE	9.5	150	\$3.61	\$3.23
<b>TIO-526</b>	<b>F028138526228</b>	SOFT-CLOSE	19	150	\$3.82	\$3.41
<b>TIO-461</b>	<b>F045138461228</b>	SELF-CLOSE	00	150	\$1.43	\$1.28
<b>TIO-462</b>	<b>F045138462228</b>	SELF-CLOSE	03	150	\$1.43	\$1.28
<b>TIO-463</b>	<b>F045138463228</b>	SELF-CLOSE	9.5	150	\$1.86	\$1.66
<b>TIO-464</b>	<b>F045138464228</b>	SELF-CLOSE	19	150	\$2.11	\$1.89

## TIOMOS 110° SCREW-ON HINGE



ITEM	MFG #	HINGE TYPE	HINGE CRANK	BOX QTY.	BROKEN BOX	FULL BOX
<b>TIO-519</b>	<b>F028138519228</b>	SOFT-CLOSE	00	150	\$3.22	\$2.88
<b>TIO-520</b>	<b>F028138520228</b>	SOFT-CLOSE	03	150	\$3.22	\$2.88
<b>TIO-521</b>	<b>F028138521228</b>	SOFT-CLOSE	9.5	150	\$3.61	\$3.23
<b>TIO-522</b>	<b>F028138522228</b>	SOFT-CLOSE	19	150	\$3.82	\$3.41
<b>TIO-457</b>	<b>F045138457228</b>	SELF-CLOSE	00	150	\$1.43	\$1.28
<b>TIO-458</b>	<b>F045138458228</b>	SELF-CLOSE	03	150	\$1.43	\$1.28
<b>TIO-459</b>	<b>F045138459228</b>	SELF-CLOSE	9.5	150	\$1.86	\$1.66
<b>TIO-460</b>	<b>F045138460228</b>	SELF-CLOSE	19	150	\$2.11	\$1.89

## TIOMOS ANGLE REDUCTION CLIP



WORKS FOR ALL TIOMOS 110° AND 120° STANDARD HINGES. REDUCES THE OPENING ANGLE TO 85° TO PREVENT DOORS FROM BUMPING FRONTS OR WALLS IN CORNER INSTALLATIONS.

ITEM	BOX QTY.	BROKEN BOX	FULL BOX
<b>TIO-751</b>	50	\$0.49	\$0.44

## TIOMOS 160° SCREW-ON HINGE



ITEM	MFG #	HINGE TYPE	HINGE CRANK	BOX QTY.	BROKEN BOX	FULL BOX
<b>TIO-561</b>	<b>F028138561217</b>	SOFT-CLOSE	00	50	\$6.33	\$5.65
<b>TIO-562</b>	<b>F028138562217</b>	SOFT-CLOSE	03	50	\$6.13	\$5.48
<b>TIO-563</b>	<b>F028138563217</b>	SOFT-CLOSE	9.5	50	\$6.71	\$5.99
<b>TIO-499</b>	<b>F045138499217</b>	SELF-CLOSE	00	50	\$4.41	\$3.94
<b>TIO-500</b>	<b>F045138500217</b>	SELF-CLOSE	03	50	\$3.85	\$3.44
<b>TIO-501</b>	<b>F045138501217</b>	SELF-CLOSE	9.5	50	\$4.80	\$4.29

## TIOMOS 160° DOWELLED HINGE



ITEM	MFG #	HINGE TYPE	HINGE CRANK	BOX QTY.	BROKEN BOX	FULL BOX
<b>TIO-564</b>	<b>F028138564217</b>	SOFT-CLOSE	00	50	\$6.33	\$5.65
<b>TIO-565</b>	<b>F028138565217</b>	SOFT-CLOSE	03	50	\$6.13	\$5.48
<b>TIO-566</b>	<b>F028138566217</b>	SOFT-CLOSE	9.5	50	\$6.71	\$5.99
<b>TIO-502</b>	<b>F045138502217</b>	SELF-CLOSE	00	50	\$4.41	\$3.94
<b>TIO-503</b>	<b>F045138503217</b>	SELF-CLOSE	03	50	\$3.85	\$3.44
<b>TIO-504</b>	<b>F045138504217</b>	SELF-CLOSE	9.5	50	\$4.80	\$4.29

## TIOMOS PIE-CUT CORNER HINGE



ITEM	MFG #	HINGE TYPE	BOX QTY.	BROKEN BOX	FULL BOX
<b>TIO-517</b>	<b>F045138517228</b>	SELF-CLOSE	50	\$6.33	\$5.65

USE WITH OMM PLATE

## TIOMOS FRAMELESS BASE PLATES



ITEM	MFG #	PLATE HEIGHT	ATTACHED VIA	BOX QTY.	BROKEN BOX	FULL BOX
<b>TIO-746</b>	<b>F058139746228</b>	0	WOOD SCREW	150	\$0.48	\$0.43
<b>TIO-747</b>	<b>F058139747228</b>	2	WOOD SCREW	150	\$0.52	\$0.46
<b>TIO-748</b>	<b>F058139748228</b>	3	WOOD SCREW	150	\$0.55	\$0.49
<b>TIO-749</b>	<b>F058139749228</b>	3.5	WOOD SCREW	150	\$0.57	\$0.51
<b>TIO-892</b>	<b>F058139892217</b>	6	WOOD SCREW	50	\$1.19	\$1.06
<b>TIO-888</b>	<b>F058139888217</b>	9.5	WOOD SCREW	50	\$1.34	\$1.20
<b>TIO-893</b>	<b>F058139893217</b>	12	WOOD SCREW	50	\$1.65	\$1.48
<b>TIO-894</b>	<b>F058139894217</b>	19	WOOD SCREW	50	\$1.97	\$1.76
<b>TIO-895</b>	<b>F058139895217</b>	21	WOOD SCREW	50	\$2.28	\$2.04

## TIOMOS FACE FRAME ADAPTER PLATES



ITEM	MFG #	PLATE HEIGHT	ATTACHED VIA	BOX QTY.	BROKEN BOX	FULL BOX
<b>TIO-825</b>	<b>F058139825228</b>	1.5	WOOD SCREW	150	\$0.74	\$0.66
<b>TIO-826</b>	<b>F058139826228</b>	3.5	WOOD SCREW	150	\$0.83	\$0.74
<b>TIO-827</b>	<b>F058139827228</b>	4.5	WOOD SCREW	150	\$0.91	\$0.81
<b>TIO-828</b>	<b>F058139828228</b>	5	WOOD SCREW	150	\$0.98	\$0.88
<b>TIO-831</b>	<b>F058139831228</b>	INSET	WOOD SCREW	150	\$1.65	\$1.48



# TIOMOS FLAP HINGE



ITEM	COLOR	MFG #	BOX QTY.	BROKEN BOX	FULL BOX
TIO-677	NIGHT	F053139677223	100	\$7.46	\$6.66
TIO-671	NICKEL	F053139671223	100	\$5.81	\$5.41

## TIOMOS Face Frame Applications

### INSET (FACE FRAME)

Hinge Crank	Plate	Drilling Distance
Use any 9.5" Crank Hinge	Use the Face Frame Inset Plate	4 mm (5/32")

### 1/4" OVERLAY

Hinge Crank	Plate	Drilling Distance
Use any 9.5" Crank Hinge	Use a 3.5 Plate	4 mm (5/32")

### 3/8" OVERLAY

Hinge Crank	Plate	Drilling Distance
Use any 9.5" Crank Hinge w/adjustment	Use a 1.5 Plate	4 mm (5/32")

### 1/2" OVERLAY

Hinge Crank	Plate	Drilling Distance
Use any 03 Crank Hinge	Use a 3.5 Plate	4 mm (5/32")

### 5/8" OVERLAY

Hinge Crank	Plate	Drilling Distance
Use any 00 Crank Hinge	Use a 3.5 Plate	4 mm (5/32")

### 3/4" OVERLAY

Hinge Crank	Plate	Drilling Distance
Use any 00 Crank Hinge	Use a 1.5 Plate	6 mm (15/64")

### 7/8" OVERLAY

Hinge Crank	Plate	Drilling Distance
Use any 00 Crank Hinge w/adjustment	Use a 1.5 Plate	7 mm (9/32")

## TIOMOS Frameless Applications

### INSET (For 110° - 95°)

Hinge Crank	Plate	Drilling Distance
Use any 110°/95° opening hinge with 19 Crank	Use the Frameless 00 Plate	4 mm (5/32")

### INSET (For 160°)

Hinge Crank	Plate	Drilling Distance
Use any 160° opening hinge with 03 Crank	Use the Frameless 19 Plate <i>Special Order</i>	4 mm (5/32")

### 1/4" OVERLAY

Hinge Crank	Plate	Drilling Distance
Use any 9.5" Crank Hinge	Use a 3 or 3.5 Plate	4 mm (5/32")

### 3/8" OVERLAY

Hinge Crank	Plate	Drilling Distance
Use any 9.5" Crank Hinge	Use a 00 Plate	4 mm (5/32")

### 1/2" OVERLAY

Hinge Crank	Plate	Drilling Distance
Use any 03 Crank Hinge	Use a 3.5 Plate	4 mm (5/32")

### 5/8" OVERLAY

Hinge Crank	Plate	Drilling Distance
Use any 03 Crank Hinge	Use a 00 Plate	4 mm (5/32")

### 3/4" OVERLAY

Hinge Crank	Plate	Drilling Distance
Use any 00 Crank Hinge	Use a 00 Plate	4 mm (5/32")

### 7/8" OVERLAY

Hinge Crank	Plate	Drilling Distance
Use any 00 Crank Hinge	Use a 00 Plate	7 mm (5/32")

## NEXIS 110° IMPRESSO HINGE



ITEM	MFG #	HINGE TYPE	HINGE CRANK	BOX QTY.	BROKEN BOX	FULL BOX
<b>NEX-622-50-0015</b>	<b>138.622.50.0015</b>	SELF-CLOSE	00	125	\$1.88	\$1.68
<b>NEX-622-50-0815</b>	<b>138.622.50.0815</b>	SELF-CLOSE	08	125	\$2.13	\$1.90
<b>*NEX-604-51-1515</b>	<b>138.604.51.1515</b>	SELF-CLOSE	15	125	\$2.38	\$2.13

\*ITEMS 100° OPENING ANGLE

## NEXIS 110° SCREW-ON HINGE



ITEM	MFG #	HINGE TYPE	HINGE CRANK	BOX QTY.	BROKEN BOX	FULL BOX
<b>NEX-322-53-0015</b>	<b>148.322.53.0015</b>	SELF-CLOSE	00	250	\$1.16	\$1.04
<b>NEX-322-53-0815</b>	<b>148.322.53.0815</b>	SELF-CLOSE	08	250	\$1.68	\$1.50

## NEXIS 110° DOWELLED HINGE



ITEM	MFG #	HINGE TYPE	HINGE CRANK	BOX QTY.	BROKEN BOX	FULL BOX
<b>NEX-322-54-0015</b>	<b>148-322-54-0015</b>	SELF-CLOSE	00	250	\$1.16	\$1.04
<b>NEX-322-54-1815</b>	<b>148-322-54-0815</b>	SELF-CLOSE	08	250	\$1.76	\$1.58
<b>*NEX-304-54-1515</b>	<b>148.304.54.1515</b>	SELF-CLOSE	15	250	\$1.62	\$1.45

\*ITEMS 100° OPENING ANGLE

## NEXIS 170° SCREW-ON HINGE



ITEM	MFG #	HINGE TYPE	HINGE CRANK	BOX QTY.	BROKEN BOX	FULL BOX
<b>NEX-765-53-0015</b>	<b>148.765.53.0015</b>	SELF-CLOSE	00	250	\$3.61	\$3.23
<b>NEX-765-53-0815</b>	<b>148.765.53.0815</b>	SELF-CLOSE	08	250	\$4.93	\$4.40

## NEXIS 170° DOWELLED HINGE



ITEM	MFG #	HINGE TYPE	HINGE CRANK	BOX QTY.	BROKEN BOX	FULL BOX
<b>NEX-765-54-0015</b>	<b>148.765.54.0015</b>	SELF-CLOSE	00	250	\$3.70	\$3.30
<b>NEX-765-82-0815</b>	<b>148.765.54.0815</b>	SELF-CLOSE	08	250	\$5.01	\$4.48

## NEXIS PIE-CUT CORNER HINGE



ITEM	MFG #	HINGE TYPE	BOX QTY.	BROKEN BOX	FULL BOX
<b>NEX-PIE</b>	<b>70139-10</b>	SELF-CLOSE	125	\$5.00	\$4.46

## NEXIS FACE FRAME ADAPTER PLATES



ITEM	MFG #	PLATE HEIGHT	ATTACHED VIA	BOX QTY.	BROKEN BOX	FULL BOX
<b>NEX-290-91-0015</b>	<b>346-290-91-0015</b>	00	WOOD SCREW	250	\$0.83	\$0.74
<b>NEX-290-91-0215</b>	<b>346-290-91-0215</b>	02	WOOD SCREW	250	\$0.85	\$0.76
<b>NEX-290-91-0415</b>	<b>346-290-91-0415</b>	04	WOOD SCREW	250	\$0.87	\$0.76
<b>NEX-290-90-0215</b>	<b>346-290-90-0215</b>	INSET	WOOD SCREW	250	\$1.44	\$1.29

## NEXIS FRAMELESS BASE PLATES



ITEM	MFG #	PLATE HEIGHT	ATTACHED VIA	BOX QTY.	BROKEN BOX	FULL BOX
<b>NEX-493-71-0015</b>	<b>314-493-71-0015</b>	00	WOOD SCREW	250	\$0.83	\$0.74
<b>NEX-493-71-0215</b>	<b>314-493-71-0215</b>	02	WOOD SCREW	250	\$0.85	\$0.76
<b>NEX-493-71-0415</b>	<b>314-493-71-0415</b>	04	WOOD SCREW	250	\$0.87	\$0.76
<b>NEX-493-71-0815</b>	<b>314-493-71-0815</b>	08	WOOD SCREW	250	\$1.44	\$1.29

## NEXIS Face Frame Applications

### INSET (FACE FRAME)

Hinge Crank	Plate	Drilling Distance
Use any 08 Crank Hinge	Use the Face Frame Inset Plate	4 mm (5/32")

### INSET (FRAMELESS)

Hinge Crank	Plate	Drilling Distance
Use any 15 Crank Hinge	Use the Frameless 04 Plate	4 mm (5/32")

### 1/4" OVERLAY

Hinge Crank	Plate	Drilling Distance
Use any 08 Crank Hinge	Use a 02 Plate	4 mm (5/32")

### 3/8" OVERLAY

Hinge Crank	Plate	Drilling Distance
Use any 08 Crank Hinge	Use a 00 Plate	4 mm (5/32")

### 1/2" OVERLAY

Hinge Crank	Plate	Drilling Distance
Use any 00 Crank Hinge	Use a 04 Plate	4 mm (5/32")

### 11/16" OVERLAY

Hinge Crank	Plate	Drilling Distance
Use any 00 Crank Hinge	Use a 00 Plate	6 mm (15/64")

## INSTITUTIONAL HINGES FOR FULL OVERLAY DOORS



ITEM	MFG #	COLOR	HINGE TYPE	BOX QTY.	BROKEN BOX	FULL BOX
<b>MB8310-014</b>	<b>F150000014223</b>	NICKEL	INSTITUTIONAL	100	\$7.81	\$6.98
<b>MB8310-125</b>	<b>F150145125223</b>	BLACK	INSTITUTIONAL	100	\$9.341	\$8.40

## UNISOFT ADAPTER



ITEM	MFG #	BOX QTY.	BROKEN BOX	FULL BOX
<b>SCD-18971</b>	<b>18975-17</b>	250	\$2.09	\$1.86

## SOFT-CLOSE NEXIS



ITEM	MFG #	BOX QTY.	BROKEN BOX	FULL BOX
<b>NEX200.40.0115</b>	<b>924.200.40.0115</b>	125	\$4.98	\$4.45

## EURO HINGE GUIDE

### FRAMELESS CABINETRY

FULL OVERLAY			HALF OVERLAY	
HINGE DEGREE	HINGE TYPE / 0 CRANK	PLATE TYPE / OMM	HINGE TYPE / 9 CRANK	PLATE TYPE / OMM
	<b>110/125/170</b>		<b>110</b>	
110	500.0535.05 NO DOWEL/SCREW	400.0R22.05 STEEL/CAM	500.0536.05 NO DOWEL	400.0R22.05 STEEL/CAM
110	500.0171.05 DOWEL/SCREW	400.0R23.05 ZINC/CAM	500.0279.05 DOWEL/SCREW	400.0R23.05 ZINC/CAM
110	500.0181.05 DOWEL/CAM	400.0P72.05 ZINC/CAM/EURO	500.0179.05 DOWEL/CAM	400.0P72.05 ZINC/CAM/EURO
110	500.0186.05 EZ FIX/SCREW	400.0P71.05 STEEL/CAM/ZINC		400.0P71.05 STEEL/CAM/EURO
125	500.0U85.05 NO DOWEL/CAM			
125	500.0U84.05 DOWEL/CAM			
125	500.0U94.05 LEVER TOP/CAM			
170	500.0M37.05 DOWEL/SCREW			

INSET		
HINGE DEGREE	HINGE TYPE / 15 CRANK	PLATE TYPE / 3MM
	<b>110</b>	
110	500.0537.05 NO DOWEL/SCREW	400.0R24.05 STEEL/CAM
110	500.0280.05 DOWEL/SCREW	400.0R73.05 STEEL/CAM/EURO
110	500.5280.05 DOWEL/CAM	400.0P74.05 ZINC/CAM/EURO
		400.0R25.05 ZINC/CAM

### FACE FRAME CABINETRY

3/4" OVERLAY			1/2" OVERLAY	
HINGE DEGREE	HINGE TYPE / 0 CRANK	PLATE TYPE / OMM	HINGE TYPE / 0 CRANK	PLATE TYPE / 3MM
	<b>110/125/170</b>		<b>110/125/170</b>	
110	500.0535.05 NO DOWEL/SCREW	400.3453.65 ZINC/110	500.0535.05 NO DOWEL/SCREW	400.3454.65 ZINC/110
110	500.0171.05 DOWEL/SCREW	400.3713.65 ZINC/125	500.0171.05 DOWEL/SCREW	400.3457.65 STEEL/110
110	500.0181.05 DOWEL/CAM	400.3723.65 ZINC/CAM/125	500.0181.05 DOWEL/CAM	400.3714.65 ZINC/125
110	500.0186.05 EZ FIX/SCREW		500.0186.05 EZ FIX/SCREW	400.3724.65 ZINC/125/CAM
125	500.0U85.05 NO DOWEL/CAM		500.0U85.05 NO DOWEL/CAM	
125	500.0U84.05 DOWEL/CAM		500.0U84.05 DOWEL/CAM	
125	500.0U94.05 LEVER TOP/CAM		500.0U94.05 LEVER TOP/CAM	
170	500.0M37.05 DOWEL/SCREW		500.0M37.05 DOWEL/SCREW	

INSET			3/8" OVERLAY	
HINGE DEGREE	HINGE TYPE / 9 CRANK	PLATE TYPE / 9MM	HINGE TYPE / 9 CRANK	PLATE TYPE / OMM
	<b>110/125/170</b>		<b>110</b>	
110	500.0536.05 NO DOWEL	400.3458.05 ZINC/CAM	500.0536.05 NO DOWEL	400.3453.65 ZINC/110
110	500.0279.05 DOWEL/SCREW		500.0279.05 DOWEL/SCREW	400.3713.65 ZINC/125
110	500.0179.05 DOWEL/CAM		500.0179.05 DOWEL/CAM	400.3723.65 ZINC/CAM/125

### FRAMELESS CABINETRY

FULL OVERLAY		HALF OVERLAY		INSET	
110° HINGE	OMM PLATE	110° HINGE	OMM PLATE	110° HINGE	OMM PLATE
700.0535.25	<b>600.0R23.05</b>	700.0536.25	<b>600.0R23.05</b>	700.0537.25	<b>600.0R23.05</b>
700.0181.25*		700.0179.25*		700.0280.25*	
725.0535.25		725.0536.25		725.0537.25	
725.0181.25*		725.0179.25*		725.0280.25*	

### FACE FRAME CABINETRY

3/4" OVERLAY		1/2" OVERLAY		3/8" OVERLAY		INSET	
110° HINGE	OMM PLATE	110° HINGE	3MM PLATE	110° HINGE	OMM PLATE	110° HINGE	9MM PLATE
700.0535.25	<b>600.3553.65</b>	700.0535.25	<b>600.3554.65</b>	700.0536.25	<b>600.3553.65</b>	700.0536.25	<b>600.3458.65</b>
700.0181.25*		700.0181.25*		700.0179.25*		700.0179.25*	
725.0535.25		725.0535.25		725.0536.25		725.0536.25	
725.0181.25*		725.0181.25*		725.0179.25*		725.0179.25*	

\*INCLUDES DOWELS



**110° EUROPEAN HINGES - SOFT-CLOSE WITH CAM ADJUST - *NEW!***



**700.0535.25**  
0MM CRANK  
FULL OVERLAY  
NO DOWELS



**700.0536.25**  
9MM CRANK  
HALF OVERLAY  
NO DOWELS



**700.0537.25**  
15MM CRANK  
FULL INSET  
NO DOWELS

**700.0181.25**  
0MM CRANK  
FULL OVERLAY  
WITH DOWELS

**700.0179.25**  
9MM CRANK  
HALF OVERLAY  
WITH DOWELS

**700.0280.25**  
15MM CRANK  
FULL INSET  
WITH DOWELS

ITEM	1+	100+	200+
<b>700.0535.25</b>	\$2.50	\$1.95	\$1.75
<b>700.0181.25</b>	\$2.50	\$1.95	\$1.75
<b>700.0536.25</b>	\$2.50	\$1.95	\$1.75
<b>700.0179.25</b>	\$2.50	\$1.95	\$1.75
<b>700.0537.25</b>	\$2.50	\$1.95	\$1.75
<b>700.0280.25</b>	\$2.50	\$1.95	\$1.75

**165° EUROPEAN HINGES - SOFT-CLOSE - *NEW!***



ITEM	1+	50+
<b>700.0M73.05</b>	\$4.75	\$4.50

**700.0M73.05**  
0MM CRANK  
FULL OVERLAY WITH CAM ADJUST  
WITH DOWELS  
USE WITH 600.3554.65 PLATE

**FACE FRAME MOUNTING PLATES - *NEW!***



**600.3553.65**  
0MM  
CAM ADJUSTABLE PLATE

**600.3555.65**  
6MM  
CAM ADJUSTABLE PLATE



**600.3458.65**  
9MM  
CAM ADJUSTABLE PLATE  
DESIGNED FOR INSET APPLICATIONS  
USING 9MM CRANK HINGES

**600.3554.65**  
3MM  
CAM ADJUSTABLE PLATE

ITEM	1+	100+	200+
<b>600.3553.65</b>	\$0.65	\$0.55	\$0.50
<b>600.3554.65</b>	\$0.65	\$0.55	\$0.50
<b>600.3555.65</b>	\$0.75	\$0.65	\$0.60
<b>600.3458.65</b>	\$1.10	\$0.95	\$0.85

**FRAMELESS MOUNTING PLATES - *NEW!***



**600.0R23.05**  
0MM  
CAM ADJUSTABLE PLATE

**600.0P29.05**  
9MM  
CAM ADJUSTABLE PLATE

**600.0R25.05**  
2MM  
CAM ADJUSTABLE PLATE

ITEM	1+	100+	200+
<b>600.0R23.05</b>	\$0.60	\$0.50	\$0.45
<b>600.0R25.05</b>	\$0.60	\$0.50	\$0.45
<b>600.0P29.05</b>	\$0.70	\$0.60	\$0.55

**105° PIE CORNER HINGE**



ITEM	1+	25+	100+
<b>500.OU22.05</b>	\$3.10	\$2.95	\$2.75

**500.OU22.05**  
PIE CORNER  
18MM CRANK  
PRESS-IN 8MM DOWELS  
■ USE WITH 400.0R22.05 PLATE

**270° PIE CORNER HINGE**



ITEM	1+	25+	100+
<b>500.0M73.05</b>	\$3.50	\$3.25	\$3.10

**500.0M73.05**  
PIE CORNER  
0MM CRANK  
DOWELS  
■ USE WITH 400.3454.65 PLATE

**110° EUROPEAN HINGES**



**500.0536.05**  
HALF OVERLAY  
9MM CRANK  
NO DOWELS



**500.0537.05**  
FULL INSET  
15MM CRANK  
NO DOWELS

**500.0280.05**  
FULL INSET  
15MM CRANK  
PRESS-IN 8MM DOWELS

ITEM	1+	25+	100+	200+
<b>500.0161.05</b>	\$1.50	\$1.25	\$1.05	\$0.89
<b>500.0179.05</b>	\$1.50	\$1.25	\$1.05	\$0.89
<b>500.0536.05</b>	\$1.50	\$1.20	\$1.10	\$1.05
<b>500.0181.05</b>	\$1.50	\$1.25	\$1.05	\$0.89
<b>500.0535.05</b>	\$1.50	\$1.20	\$1.10	\$1.05
<b>500.0280.05</b>	\$1.50	\$1.20	\$1.10	\$1.05
<b>500.0537.05</b>	\$1.50	\$1.20	\$1.10	\$1.05



**500.0161.05**  
90° FULL OVERLAY  
0MM CRANK  
PRESS-IN 8MM DOWELS



**500.0179.05**  
HALF OVERLAY  
9MM CRANK  
PRESS-IN 8MM DOWELS  
CAM ADJUST



**500.0181.05**  
FULL OVERLAY  
0MM CRANK  
PRESS-IN 8MM DOWELS  
CAM ADJUST

**500.0535.05**  
FULL OVERLAY  
0MM CRANK  
NO DOWELS  
CAM ADJUST

**FACE FRAME MOUNTING PLATES**

- 110° FOR FACE FRAME CONSTRUCTION
- HEIGHT ADJUSTMENT +/- 3.5MM
- SOLD WITHOUT SCREWS



**400.3453.65**  
ZINC DIE CAST, NICKEL PLATED



**400.3454.65**  
STAMPED STEEL, NICKEL PLATED  
■ USE #6 X 5/8" FLAT HEAD WOOD SCREWS FOR ATTACHMENT



**400.3458.65**  
ZINC DIE CAST, NICKEL PLATED  
■ USE #8 X 3/4" PAN HEAD WOOD SCREWS FOR ATTACHMENT  
■ DESIGNED FOR INSET APPLICATIONS USING 9MM CRANK HINGES

**400.3454.65**  
ZINC DIE CAST, NICKEL PLATED  
**400.3455.65**  
ZINC DIE CAST, NICKEL PLATED  
■ USE #6 X 5/8" FLAT HEAD WOOD SCREWS FOR ATTACHMENT

ITEM	1+	25+	100+
<b>400.3453.65</b>	\$0.89	\$0.69	\$0.55
<b>400.3454.65</b>	\$0.89	\$0.69	\$0.55
<b>400.3455.65</b>	\$0.95	\$0.79	\$0.65
<b>400.3457.65</b>	\$0.60	\$0.45	\$0.30
<b>400.3458.65</b>	\$1.40	\$1.25	\$1.10

**FRAMELESS MOUNTING PLATES**

- FOR FRAMELESS CONSTRUCTION



**400.0P71.05**  
COLD ROLLED STEEL, NICKEL PLATED



**400.0P72.05**  
ZINC DIE CAST, NICKEL PLATED

**400.0P73.05**  
COLD ROLLED STEEL, NICKEL PLATED  
■ PREASSEMBLED WITH 6.3MM X 15MM EURO SYSTEM SCREWS  
■ HEIGHT ADJUSTMENT: +/- 2MM

**400.0P74.05**  
ZINC DIE CAST, NICKEL PLATED  
■ PREASSEMBLED WITH 6.3MM X 15MM EURO SYSTEM SCREWS  
■ HEIGHT ADJUSTMENT: +/- 2MM

ITEM	1+	25+	100+
<b>400.0P71.05</b>	\$0.85	\$0.69	\$0.55
<b>400.0P73.05</b>	\$0.85	\$0.69	\$0.55
<b>400.0P72.05</b>	\$1.25	\$1.10	\$0.95
<b>400.0P74.05</b>	\$1.25	\$1.10	\$0.95
<b>400.0R22.05</b>	\$0.85	\$0.69	\$0.55
<b>400.0R24.05</b>	\$0.85	\$0.69	\$0.55
<b>400.0R23.05</b>	\$1.10	\$0.95	\$0.85
<b>400.0R25.05</b>	\$1.10	\$0.95	\$0.85



**400.0R22.05**  
COLD ROLLED STEEL, NICKEL PLATED

**400.0R24.05**  
COLD ROLLED STEEL, NICKEL PLATED  
■ SOLD WITHOUT SCREWS  
■ USE #6 X 5/8" FLAT HEAD WOOD SCREWS FOR ATTACHMENT  
■ HEIGHT ADJUSTMENT: +/- 2MM



**400.0R23.05**  
ZINC DIE CAST, NICKEL PLATED  
**400.0R25.05**  
ZINC DIE CAST, NICKEL PLATED  
■ SOLD WITHOUT SCREWS  
■ USE #6 X 5/8" FLAT HEAD WOOD SCREWS FOR ATTACHMENT  
■ HEIGHT ADJUSTMENT: +/- 2MM

## 105° SOFT-CLOSE COMPACT HINGE - 6 WAY ADJUSTMENT



**7390**  
1/2" OVERLAY  
NO DOWELS



**7390-2-000**  
1/2" OVERLAY  
PRESS-IN 8MM DOWELS



**7390-716**  
7/16" OVERLAY  
PRESS-IN 8MM DOWELS

ITEM	1+	25+	100+
<b>7390</b>	\$2.25	\$1.95	\$1.74
<b>7390-2-000</b>	\$2.25	\$1.95	\$1.75
<b>7390-716</b>	\$2.25	\$1.95	\$1.75
<b>7390-6-000</b>	\$2.25	\$1.95	\$1.75
<b>7391-000</b>	\$2.25	\$1.95	\$1.75
<b>7392-000</b>	\$2.95	\$2.50	\$2.25
<b>7393-000</b>	\$2.95	\$2.50	\$2.25
<b>7394-000</b>	\$2.95	\$2.50	\$2.25



**7390-6-000**  
3/4" OVERLAY  
PRESS-IN 8MM DOWELS



**7391-000**  
1" OVERLAY  
PRESS-IN 8MM DOWELS



**7392-000**  
1 1/2" OVERLAY  
PRESS-IN 8MM DOWELS



**7393-000**  
1 3/8" OVERLAY  
PRESS-IN 8MM DOWELS



**7394-000**  
1 1/4" OVERLAY  
PRESS-IN 8MM DOWELS

## 105° COMPACT HINGE - 6 WAY ADJUSTMENT



**3390**  
1/2" OVERLAY  
NO DOWELS



**3390-2-000**  
1/2" OVERLAY  
PRESS-IN 8MM DOWELS



**3390-716**  
7/16" OVERLAY  
PRESS-IN 8MM DOWELS



**3390-6-000**  
3/4" OVERLAY  
PRESS-IN 8MM DOWELS

ITEM	1+	25+	100+
<b>3390</b>	\$1.25	\$1.10	\$0.95
<b>3390-2-000</b>	\$1.25	\$1.10	\$0.95
<b>3390-716</b>	\$1.25	\$1.10	\$0.95
<b>3390-6-000</b>	\$1.25	\$1.10	\$0.95
<b>3391-000</b>	\$1.25	\$1.10	\$0.95
<b>3392-000</b>	\$1.95	\$1.75	\$1.50
<b>3393-000</b>	\$1.95	\$1.75	\$1.50
<b>3394-000</b>	\$1.95	\$1.75	\$1.50
<b>3390-SC</b>	\$2.00	\$1.75	-

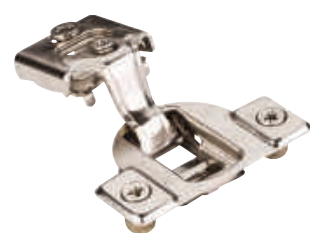

**3391-000**  
1" OVERLAY  
PRESS-IN 8MM DOWELS



**3392-000**  
1 1/2" OVERLAY  
PRESS-IN 8MM DOWELS



**3393-000**  
1 3/8" OVERLAY  
PRESS-IN 8MM DOWELS



**3394-000**  
1 1/4" OVERLAY  
PRESS-IN 8MM DOWELS



**3390-SC**  
CLIP-ON  
SOFT NOSE DAMPER

## 105° COMPACT HINGE - SOFT-CLOSE - 1/2" OVERLAY



**22855-10SFT**  
CAM ADJUSTABLE PLATE  
NO DOWELS

**22855-9SFT**  
CAM ADJUSTABLE PLATE  
WITH DOWELS

ITEM	1+	100+	200+
<b>22855-10SFT</b>	\$1.50	\$1.30	\$1.15
<b>22855-9SFT</b>	\$1.55	\$1.35	\$1.20

## 125° COMPACT HINGE - 6 WAY ADJUSTMENT

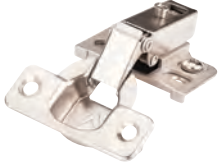

**22855-9**  
1/2" OVERLAY WITH CAM  
ADJUSTABLE PLATE  
PRESS-IN 8MM DOWELS



**22855-7-000N**  
1/2" OVERLAY  
PRESS-IN 8MM DOWELS



**22855-6-000N**  
3/4" OVERLAY  
PRESS-IN 8MM DOWELS

ITEM	1+	100+	200+
<b>22855-9</b>	\$0.95	\$0.85	\$0.75
<b>22855-10</b>	\$0.95	\$0.85	\$0.75
<b>22855-6-000N</b>	\$1.00	\$0.90	\$0.80
<b>22855-7-000N</b>	\$0.90	\$0.80	\$0.70
<b>22855-8-000N</b>	\$0.90	\$0.80	\$0.70

**22855-10**  
1/2" OVERLAY WITH CAM  
ADJUSTABLE PLATE  
NO DOWELS

**22855-8-000N**  
1/2" OVERLAY  
NO DOWELS

## REPLACEMENT BITS



**V203351**



**V201008**



**V301008**

PART #	SIZE	1 PC
<b>V201008</b>	8MM RIGHT HAND	\$9.95
<b>V301008</b>	8MM LEFT HAND	\$9.95
<b>V203351</b>	35MM CENTER	\$26.95

## PUSH TO OPEN SOFT CLOSE SLIDE - *NEW!*

- 100 LB CAPACITY SOFT CLOSING MECHANISM
- FULL EXTENSION
- 45 MM
- NON-HANDED SIDE MOUNT WITH FLEXIBLE MOUNTING TABS FOR FRAMELESS AND FACE CABINETS
- EASY ACCESS 32 MM SYSTEM HOLE PATTERN
- 1/2" SIDE SPACING
- CLEAR ZINC ELECTROPLATED
- LUBRICATED STEEL BALL BEARING WITH PATENTED CAGE HOLD FORWARD-RETAINS CAGE DURING DRAWER MEMBER INSTALLATION
- NON-HANDED TRIGGER DISCONNECT
- SGS CERTIFIED 50K CYCLES

ITEM	LENGTH	1 BOX	6 BOXES
<b>303-200-14</b>	14"	\$11.11/PR	\$9.92/PR
<b>303-200-14</b>	16"	\$11.59/PR	\$10.35/PR
<b>303-200-18</b>	18"	\$12.02/PR	\$10.73/PR
<b>303-200-20</b>	20"	\$12.33/PR	\$11.01/PR
<b>303-200-22</b>	22"	\$12.76/PR	\$11.40/PR





## THE H-SELECT SLIDE

- UNASSEMBLED FOR EASIER AND FASTER INSTALLATION
- HEAVY DUTY FULL EXTENSION BALL BEARING SLIDES
- 100 LB RATING
- EASY ACCESS 32MM SYSTEM HOLE PATTERN ACCEPTS EUROPEAN AND WOOD SCREWS (6.3MM EURO SCREW OR #8 X 7/16" TRUSS HEAD SCREW RECOMMENDED)
- 1/2" SIDE SPACING
- 1.0MM X 1.0MM X 1.2MM COLD ROLLED STEEL

<b>HH-10-BL</b> BLACK 10" L	<b>HH-24-BL</b> BLACK 24" L	<b>HH-18-Z</b> ZINC 18" L
<b>HH-12-BL</b> BLACK 12" L	<b>HH-22-BL</b> BLACK 22" L	<b>HH-20-Z</b> ZINC 20" L
<b>HH-14-BL</b> BLACK 14" L	<b>HH-10-Z</b> ZINC 10" L	<b>HH-22-Z</b> ZINC 22" L
<b>HH-16-BL</b> BLACK 16" L	<b>HH-12-Z</b> ZINC 12" L	<b>HH-24-Z</b> ZINC 24" L
<b>HH-18-BL</b> BLACK 18" L	<b>HH-14-Z</b> ZINC 14" L	<b>HH-26-Z</b> ZINC 26" L
<b>HH-20-BL</b> BLACK 20" L	<b>HH-16-Z</b> ZINC 16" L	<b>HH-28-Z</b> ZINC 28" L

**Call for 500PR and Container Pricing**

ITEM	ITEM	1 BOX	6 BOXES	10 BOXES
<b>HH-10-BL</b>	<b>HH-10-Z</b>	\$3.06/PR	\$2.51/PR	\$2.12/PR
<b>HH-12-BL</b>	<b>HH-12-Z</b>	\$3.61/PR	\$3.05/PR	\$2.67/PR
<b>HH-14-BL</b>	<b>HH-14-Z</b>	\$4.26/PR	\$3.57/PR	\$3.09/PR
<b>HH-16-BL</b>	<b>HH-16-Z</b>	\$4.70/PR	\$4.06/PR	\$3.55/PR
<b>HH-18-BL</b>	<b>HH-18-Z</b>	\$5.24/PR	\$4.44/PR	\$3.99/PR
<b>HH-20-BL</b>	<b>HH-20-Z</b>	\$5.41/PR	\$4.77/PR	\$4.32/PR
<b>HH-22-BL</b>	<b>HH-22-Z</b>	\$5.95/PR	\$5.09/PR	\$4.65/PR
<b>HH-24-BL</b>	<b>HH-24-Z</b>	\$6.28/PR	\$5.52/PR	\$5.03/PR
-	<b>HH-26-Z</b>	\$6.88/PR	\$6.12/PR	\$5.46/PR
-	<b>HH-28-Z</b>	\$7.43/PR	\$6.45/PR	\$6.00/PR

15 PAIRS PER BOX



**HEAVY DUTY REAR MOUNTING BRACKET HH2**



**REAR MOUNTING BRACKET HH3**



ITEM	SOLD IN	1 PC	1 CASE	1000 PCS
<b>HH2</b>	PIECES	\$0.43	\$0.37	\$0.30
<b>HH3</b>	PIECES	\$0.43	\$0.34	\$0.26

200 PIECES PER BOX

## EURO SLIDES

- 75 LB CAPACITY
- RIDE HEIGHT 12MM
- 32MM SYSTEM SCREW HOLE PATTERNS
- ONE SIDE CAPTIVE PROFILE ELIMINATES SIDE PLAY
- POSITIVE STAY CLOSED FEATURE
- DOUBLE OUT STOP
- DOUBLE SCREW HOLES ON CABINET MEMBER- #6 FLAT HEAD SCREW AND EURO SCREW (SMALL AND LARGE HOLES)



<b>DRS-12</b> 12" L	<b>DRS-18</b> 18" L
<b>DRS-14</b> 14" L	<b>DRS-20</b> 20" L
<b>DRS-16</b> 16" L	<b>DRS-22</b> 22" L

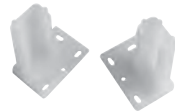

**SOCKETS DRS1**

ITEM	SOLD IN	1 BOX	10 BOXES
<b>DRS-12</b>	BOXES	\$1.50/PR	\$1.15/PR
<b>DRS-14</b>	BOXES	\$1.60/PR	\$1.20/PR
<b>DRS-16</b>	BOXES	\$1.70/PR	\$1.30/PR
<b>DRS-18</b>	BOXES	\$1.90/PR	\$1.50/PR
<b>DRS-20</b>	BOXES	\$2.20/PR	\$1.75/PR
<b>DRS-22</b>	BOXES	\$2.65/PR	\$2.10/PR

20 PAIRS PER BOX  
CALL FOR PRICE ON 30 BOXES

ITEM	SOLD IN	1 PR
<b>DRS1</b>	PAIRS	\$0.45

## POCKET DOOR HARDWARE

- ALL SLIDES ARE BLACK
- 30 POUND WEIGHT CAPACITY
- POLY-BAGGED COMPLETE WITH 3MM HINGES. EVERYTHING TO DO ONE DOOR
- FOLLOWER STRIP IS INSTALLED AFTER THE SLIDES ARE MOUNTED
- THREE STEEL BALL BEARINGS PER INCH OF RACE FOR SMOOTH, QUIET MOVEMENT



ITEM	LENGTH	1+
KV8070-12	12"	\$36.50
KV8070-14	14"	\$36.95
KV8070-16	16"	\$38.50
KV8070-18	18"	\$38.95
KV8070-20	20"	\$39.25
KV8070-22	22"	\$39.50
KV8070-24	24"	\$39.95

## SOFT PRO X SERIES SIDEMOUNT SOFT-CLOSE - **NEW!**

- ONLY 1/16" (2MM) REQUIRED TO ENGAGE DRAWER OPENING
- NON-HANDED DISCONNECT RELEASE
- CLEAR ZINC FINISH
- SCREW MOUNTING SYSTEM 32 MM COMPATIBLE
- SUITABLE FOR INSET OR OVERLAY DRAWER FRONTS
- 7/32" (13MM) SIDE SPACING
- 100 LB. CAPACITY
- BRIGHT ZINC FINISH



<b>4903-10-ZP</b> ZINC 10" L	<b>4903-18-ZP</b> BLACK 18" L	<b>4903-26-ZP</b> ZINC 26" L
<b>4903-12-ZP</b> ZINC 12" L	<b>4903-20-ZP</b> BLACK 20" L	<b>4903-28-ZP</b> ZINC 28" L
<b>4903-14-ZP</b> ZINC 14" L	<b>4903-22-ZP</b> ZINC 22" L	
<b>4903-16-ZP</b> ZINC 16" L	<b>4903-24-ZP</b> ZINC 24" L	



**REAR MOUNTING BRACKET  
4903-BRKT**

ITEM	BOX QTY	1 BOX	6 BOXES	10 BOXES
4903-10-ZP	10	\$5.65/PR	\$5.18/PR	\$4.71/PR
4903-12-ZP	10	\$6.53/PR	\$5.99/PR	\$5.45/PR
4903-14-ZP	10	\$7.24/PR	\$6.63/PR	\$6.03/PR
4903-16-ZP	10	\$7.90/PR	\$7.24/PR	\$6.58/PR
4903-18-ZP	10	\$8.71/PR	\$7.99/PR	\$7.26/PR
4903-20-ZP	10	\$9.31/PR	\$8.53/PR	\$7.76/PR
4903-22-ZP	10	\$10.01/PR	\$9.15/PR	\$8.29/PR
4903-24-ZP	10	\$10.71/PR	\$9.79/PR	\$8.87/PR
4903-26-ZP	10	\$12.79/PR	\$11.70/PR	\$10.60/PR
4903-28-ZP	10	\$13.75/PR	\$12.80/PR	\$11.94/PR

ITEM	BOX QTY	BROKEN BOX	FULL BOX
4903-BRKT	200 PC	\$0.50/EA	\$0.45/EA

## 8500 SERIES UNDERMOUNT SOFT-CLOSE - **NEW!**

- PRICE INCLUDES 3-WAY FRONT LOCKING CLIPS



**REAR MOUNTING BRACKET  
8000-BRKT**

ITEM	1+	100+	SKID
8500-12-SOFT	\$7.75	\$7.00	\$6.50
8500-15-SOFT	\$7.75	\$7.00	\$6.50
8500-18-SOFT	\$9.58	\$8.95	\$8.31
8500-21-SOFT	\$10.17	\$9.49	\$8.81

ITEM	BOX QTY	BROKEN BOX	FULL BOX
8000-BRKT	200 PC	\$0.37/EA	\$0.32/EA

## CGS LOW COST UNDERMOUNT



**CLIP  
CGS1069-RM**

**CLIP  
CGS1068-1D**

**CLIP  
CGS1067-3D**

ITEM	1+	100+	200+
CGS1073-12	\$8.75	\$7.95	\$7.50
CGS1072-15	\$9.75	\$8.90	\$8.25
CGS1071-18	\$10.95	\$9.99	\$9.25
CGS1070-21	\$12.04	\$11.21	\$10.38

6 PAIRS PER BOX  
CALL FOR SKID PRICING

ITEM	BROKEN BOX	UNBROKEN BOX 100 PR
CGS1068-1D	\$.80 pr.	\$.69 pr.
CGS1067-3D	\$1.69 pr.	\$1.51 pr.
CGS1069-RM	\$.26 ea.	\$.23 ea.

# SLIDING TRAY HARDWARE

- 3/4 EXTENSION
- USE WITH ANY UNIT WITHOUT A SIDEWALL
- VARIABLE HEIGHT MOUNTING BRACKETS
- LOCK LATCH FOR IN/OUT
- DETENT IN OPEN POSITION AND DISCONNECT

ITEM	1 PR	20 PR
<b>DKB-18</b>	\$8.95	\$6.95



**DKB-18**  
ROLLED STEEL WITH BLACK FINISH



SLIDING TRAY - KING SLIDE

## KING SLIDE

ITEM	DRAWER LENGTH	OVERALL CABINET DEPTH	MAX	MIN	PROFILE LENGTH	1 PR	18 PR	48 PR
<b>F229-9</b>	9"	12"	11 9/16"	9 7/8"	9 1/2"	\$18.50	\$16.50/PR	-
<b>F305-12</b>	12"	15"	14 9/16"	12 7/8"	10 1/16"	\$18.50	\$16.50/PR	\$14.95/PR
<b>F381-15</b>	15"	18"	17 9/16"	15 7/8"	15 1/2"	\$18.50	\$16.50/PR	\$14.95/PR
<b>F457-18</b>	18"	21"	20 9/16"	18 7/8"	18 1/2"	\$18.90	\$16.50/PR	\$15.25/PR
<b>F533-21</b>	21"	24"	23 9/16"	21 7/8"	21 1/2"	\$19.50	\$17.50/PR	\$15.75/PR
<b>F600-24</b>	24"	27"	600MM	200MM	24 1/2"	\$21.50	\$19.25/PR	\$18.25/PR

INCLUDES FRONT MOUNT CLIPS AND METAL BRACKETS

### Full Extension Undermount Slide with Silent Soft-Closing for Face Frame and Frameless Applications

#### Applications

- Kitchen Furniture
- Kitchen Cabinetry
- Home Cabinetry
- Box Drawers

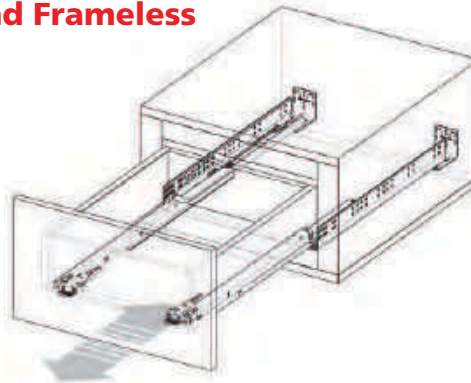

#### Specifications/Features

**Length:** 9" | 12" | 15" | 18" | 21"

: 299 | 305 | 381 | 457 | 533 mm

**Drawer Side Thickness:** 16mm (5/8") (max)

**Dynamic Load Capacity:** 75 lbs

**Static Load Capacity:** 100 lbs

**Travel:** Full extension

**Mount:** Undermount for faceframe and frameless cabinets

**Material:** Galvanized steel sheet

**Features:** Self-closing, Cushion-closing  
Tool-less height adjustment  
Locking devices easy assembly

**Packing:** Unit Packed: 6 pair/carton  
2 pairs/carton

## Space Requirement

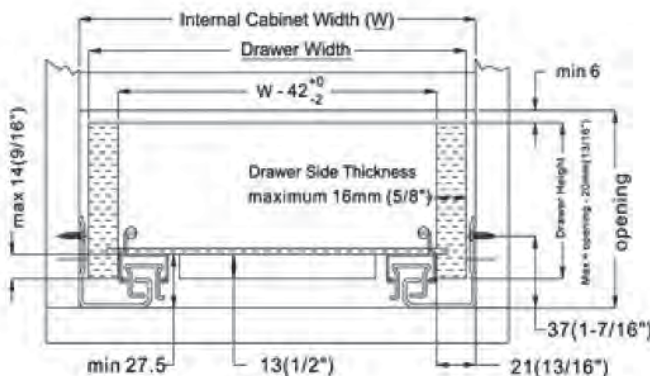

#### Drawer Width Formula

Drawer Side Thickness	"W" minus
16 (5/8")	10 (3/8")
15 (19/32")	12 (15/32")
14 (9/16")	14 (9/16")
13 (1/2")	16 (5/8")
12 (15/32")	18 (23/32")

W: Internal Cabinet Width

Example:

Internal Cabinet Width = 457 mm (18")

Drawer Side Thickness = 13 mm (1/2")

Drawer Width  
= 457 - 16 = 441 mm  
= (18") - (5/8") = 17-3/8"

## BANDED LAZY SUSAN KITS

- SHELF IS MADE FROM BIRCH PLYWOOD WITH CLEAR UV FINISH
- SHELVES HAVE A 1" INSIDE RIM HEIGHT AND 1-9/16" OVERALL HEIGHT
- INDEPENDENTLY ROTATING SHELVES
- CHROME POLE WITH NATURAL POLYMER BEARINGS THAT BLEND WITH WOODEN SHELVES
- POLE FEATURES ADJUSTABLE SHELVES
- POSITIVE STOP ON KIDNEY SHELF UNITS
- HEIGHT ADJUSTABLE FOR CABINETS WITH 25-3/4" - 33-1/2" INTERIOR HEIGHTS (38" - 45-3/4" FOR 3 TIER)
- SOLD AS COMPLETE SET WITH SHELVES, POLES, MOUNTING HARDWARE AND INSTRUCTIONS INCLUDED



ROUND

KIDNEY

## PLASTIC LAZY SUSAN KITS

- INDEPENDENTLY ROTATING SHELVES FEATURING SMOOTH SURFACE AREA
- CHROME-PLATED STAINLESS STEEL POLE WITH WHITE POLYMER HUBS AND ADJUSTABLE HEIGHT
- POLE FEATURES ADJUSTABLE SHELVES
- POSITIVE STOP ON KIDNEY SHELF UNITS
- 18" DIAMETER SHELVES HAVE 1-7/16" OVERALL RIM HEIGHT AND 9/16" INSIDE RIM HEIGHT
- 24" AND 28" DIAMETER SHELVES HAVE 1-7/8" OVERALL RIM HEIGHT AND 1" INSIDE RIM HEIGHT
- 32" DIAMETER SHELVES HAVE 2-1/8" OVERALL RIM HEIGHT AND 1-3/8" INSIDE RIM HEIGHT
- SOLD AS COMPLETE SET WITH SHELVES, POLES, MOUNTING HARDWARE AND INSTRUCTIONS INCLUDED



## ROUND

ITEM	# TRAYS	DIAMETER	INTERIOR CABINET HEIGHT	1+
<b>BLSR218-SET</b>	2	18"	24-1/2"-33-1/4"	\$87.84
<b>BLSR220-SET</b>	2	20"	24-1/2"-33-1/4"	\$90.14
<b>BLSR224-SET</b>	2	24"	24-1/2"-33-1/4"	\$106.95
<b>BLSR228-SET</b>	2	28"	24-1/2"-33-1/4"	\$121.38
<b>BLSR2318-SET</b>	3	18"	37-3/8"-46"	\$138.44
<b>BLSR2320-SET</b>	3	20"	37-3/8"-46"	\$141.86

## KIDNEY

ITEM	# TRAYS	DIAMETER	INTERIOR CABINET HEIGHT	1+
<b>BLSK224-SET</b>	2	24"	24-1/2"-33-1/4"	\$106.95
<b>BLSK228-SET</b>	2	28"	24-1/2"-33-1/4"	\$121.39
<b>BLSK232-SET</b>	2	32"	24-1/2"-33-1/4"	\$140.64

## ROUND

ITEM	# TRAYS	DIAMETER	INTERIOR CABINET HEIGHT	1+
<b>PLSR218</b>	2	18"	20-3/4"-38"	\$32.49
<b>PLSR224</b>	2	24"	20-3/4"-38"	\$45.78
<b>PLSR228</b>	2	28"	20-3/4"-38"	\$58.18
<b>PLSR2318</b>	3	18"	31-1/2"-43"	\$57.14

## KIDNEY

ITEM	# TRAYS	DIAMETER	INTERIOR CABINET HEIGHT	1+
<b>PLSK224</b>	2	24"	20-3/4"-38"	\$42.05
<b>PLSK228</b>	2	28"	20-3/4"-38"	\$48.93
<b>PLSK232</b>	2	32"	20-3/4"-38"	\$65.41



ROUND

KIDNEY

## WASTE CONTAINER - WIRE BOTTOM MOUNT

ITEM	DESCRIPTION	FINISH	WIDTH	DEPTH	HEIGHT	CABINET SIZE	1+
<b>CAN-EBMSB-R</b>	SINGLE CAN UNIT FOR 35QT OR 50QT	BLACK	10-1/4"	22-1/16"	13"	15" - 18" BASE	\$38.00
<b>CAN-EBMSW-R</b>	SINGLE CAN UNIT FOR 35QT OR 50QT	WHITE	10-1/4"	22-1/16"	13"	15" - 18" BASE	\$38.00
<b>CAN-EBMDB-R</b>	DOUBLE CAN UNIT FOR 35QT ONLY	BLACK	13-15/16"	22"	13"	18" - 24" BASE	\$48.13
<b>CAN-EBMDW-R</b>	DOUBLE CAN UNIT FOR 35QT ONLY	WHITE	13-15/16"	22"	13"	18" - 24" BASE	\$48.13
<b>CAN-EBMD50B-R</b>	DOUBLE CAN UNIT FOR 50QT ONLY	BLACK	15-3/16"	22-1/16"	12-13/16"	18" - 24" BASE	\$57.86
<b>CAN-EBMD50W-R</b>	DOUBLE CAN UNIT FOR 50QT ONLY	WHITE	15-3/16"	22-1/16"	12-13/16"	18" - 24" BASE	\$57.86
<b>CAN-DOORKIT</b>	DOOR MOUNTING KIT	BLACK	2-1/2"	5-1/4"	6-5/8"	-	\$10.68
<b>CAN-DOORKITW</b>	DOOR MOUNTING KIT	WHITE	2-1/2"	5-1/4"	6-5/8"	-	\$10.68



- HEAVY DUTY FULL EXTENSION SLIDES - 100LB LOAD RATING
- THICK WIRE FRAME CONSTRUCTION
- DURABLE PLASTIC TRASH CANS ARE EASILY CLEANED
- CANS AND LIDS SOLD SEPARATELY
- QUICKLY MOUNTS TO CABINET FLOOR USING FOUR SCREWS (INCLUDED)
- OPTIONAL DOOR MOUNTING KIT FOR DOOR PULLOUT APPLICATION
- NOTE: DOUBLE 50QT UNIT REQUIRES FULL HEIGHT CABINET

## WASTE CONTAINERS



ITEM	DESCRIPTION	COLOR	WIDTH	DEPTH	HEIGHT	1+
<b>CAN-35</b>	35QT POLYMER BIN	BLACK	9-7/16"	14-1/2"	18"	\$9.42
<b>CAN-35W</b>	35QT POLYMER BIN	WHITE	9-7/16"	14-1/2"	18"	\$9.42
<b>CAN-35LID</b>	LID FOR 35QT POLYMER BIN	BLACK	9-3/8"	14-1/2"	1-5/8"	\$5.82
<b>CAN-35LIDW</b>	LID FOR 35QT POLYMER BIN	WHITE	9-3/8"	14-1/2"	1-5/8"	\$5.82
<b>CAN-35LIDG</b>	LID FOR 35QT POLYMER BIN	GREEN	9-3/8"	14-1/2"	1-5/8"	\$5.82
<b>CAN-50</b>	50QT POLYMER BIN	BLACK	10-1/4"	14-7/8"	22-1/4"	\$15.14
<b>CAN-50W</b>	50QT POLYMER BIN	WHITE	10-1/4"	14-7/8"	22-1/4"	\$15.14
<b>CAN-50LID</b>	LID FOR 50QT POLYMER BIN	BLACK	10-1/4"	14-5/8"	1-5/8"	\$11.75
<b>CAN-50LIDW</b>	LID FOR 50QT POLYMER BIN	WHITE	10-1/4"	14-5/8"	1-5/8"	\$11.75
<b>CAN-50LIDG</b>	LID FOR 50QT POLYMER BIN	GREEN	10-1/4"	14-5/8"	1-5/8"	\$11.75

- BINS AVAILABLE IN 2 SIZES AND 2 STANDARD COLORS
- LIDS AVAILABLE IN 2 STANDARD COLORS PLUS GREEN FOR RECYCLING
- HIGH-QUALITY POLYMER MATERIAL IS DURABLE AND EASY TO CLEAN
- COMPATIBLE WITH ANY OF OUR TRASH CAN PULLOUTS



# STEMWARE AND WINE BOTTLE STORAGE

- CUT TO ANY LENGTH
- SOLD IN 8' LENGTHS



ITEM	SPECIES	WIDTH	DEPTH	1+
<b>STMW-ALD</b>	ALDER	3-3/16"	3/4"	\$31.84
<b>STMW-HMP</b>	HARD MAPLE	3-3/16"	3/4"	\$36.50

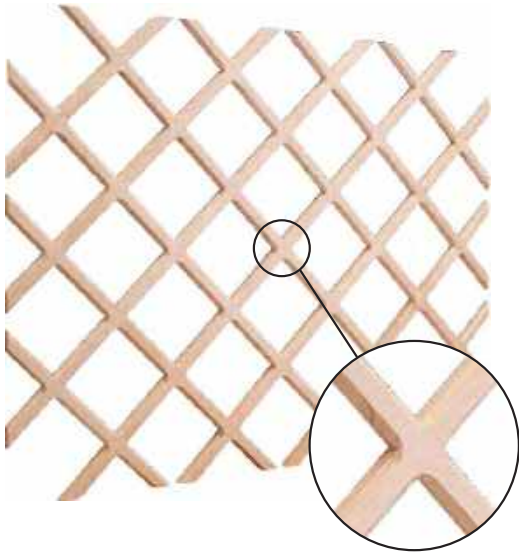

ITEM	SPECIES	WIDTH	HEIGHT	1+
<b>WR30-2ALD</b>	ALDER	24"	30"	\$40.66
<b>WR30-2MP</b>	MAPLE	24"	30"	\$39.12
<b>WR30-2OK</b>	OAK	24"	30"	\$36.29
<b>WR45-2ALD</b>	ALDER	25"	45"	\$50.98
<b>WR45-2MP</b>	MAPLE	25"	45"	\$47.78
<b>WR45-2OK</b>	OAK	25"	45"	\$46.19
<b>WR48-2ALD</b>	ALDER	36"	48"	\$77.26
<b>WR48-2MP</b>	MAPLE	36"	48"	\$74.86
<b>WR48-2OK</b>	OAK	36"	48"	\$70.67

- CAN BE CUT TO SIZE
- BEVELED MOULDINGS WITH ROUTED FACE
- MOULDINGS ARE 7/16" THICK X 3/4" WIDE
- 3-3/4" X 3-3/4" BOTTLE OPENINGS
- SOLID WOOD IS SANDED AND CAN BE FINISHED TO MATCH THE APPLICATION
- SOLD BY THE PIECE

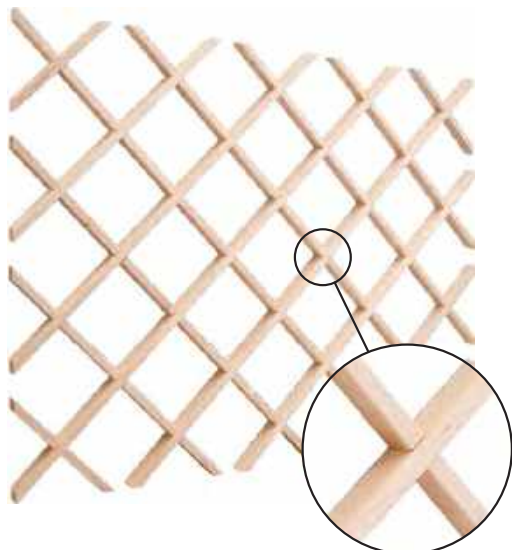

ITEM	SPECIES	WIDTH	HEIGHT	1+
<b>WR30MP</b>	MAPLE	24"	30"	\$34.24
<b>WR36MP</b>	MAPLE	36"	36"	\$58.48

- CAN BE CUT TO SIZE
- MOULDINGS ARE 3/4" THICK X 7/16" WIDE
- 4" X 4" BOTTLE OPENINGS
- SOLID MAPLE IS SANDED AND CAN BE FINISHED TO MATCH THE APPLICATION
- SOLD BY THE PIECE

## PREMIUM HANDMADE STAINLESS UNDERMOUNT SINKS

- 16 GAUGE
- 304 SS WITH SATIN FINISH
- INSULATED BOTTOM
- DRAIN OPENING 3 1/2"
- STRAINER SOLD SEPARATELY

ITEM	BOWLS	OVERALL MEASUREMENTS	BOWL MEASUREMENTS	1+
<b>HMS260L</b>	2 UNEQUAL	32" X 19" X 10"	LARGE BOWL 17" X 17" X 10" SMALL BOWL 12" X 17" X 10"	\$378.64
<b>HMS250</b>	2	32" X 19" X 10"	14-1/2" X 17" X 10"	\$378.64
<b>HMS200</b>	1	32" X 19" X 10"	30" X 17" X 10"	\$275.00
<b>HMS190</b>	1	30" X 18" X 10"	28" X 16" X 10"	\$250.00
<b>HMS175</b>	1	23" X 18" X 10"	21" X 16" X 10"	\$237.00



HMS260L



HMS250



HMS200



HMS190



HMS175



ITEM	1+
<b>STRAINER-200</b>	\$12.15

- STAINLESS STEEL
- WORKS WITH ALL SINKS LISTED

PREMIUM HANDMADE STAINLESS FARMHOUSE STYLE SINKS

- 16 GAUGE
- 304 SS WITH SATIN FINISH
- INSULATED BOTTOM
- DRAIN OPENING 3 1/2"
- STRAINER SOLD SEPARATELY

ITEM	BOWLS	OVERALL MEASUREMENTS	BOWL MEASUREMENTS	1+
HA225	2 UNEQUAL	35-7/8" X 20-3/4" X 10"	LARGE BOWL 19" X 16" X 10" SMALL BOWL 13" X 16" X 10"	\$490.00
HA200	1	35-7/8" X 20-3/4" X 10"	33" X 16" X 9"	\$425.00



HA225



HA200





## LAZY SUSANS

Polymer: 6012/6013



Mfg. #	Size	Shape	Shelves	Finish	Rotation	Hardware	Each
6012-18-15-52	18"	Full Round	2	Almond	Dependent	Included	\$40.65
6012-20-15-52	20"	Full Round	2	Almond	Dependent	Included	\$44.89
6012-28-15-52	28"	Full Round	2	Almond	Dependent	Included	\$59.78
6012-18-11-52	18"	Full Round	2	White	Dependent	Included	\$40.65
6012-20-11-52	20"	Full Round	2	White	Dependent	Included	\$44.89
6012-28-11-52	28"	Full Round	2	White	Dependent	Included	\$59.78

*Post adjusts from: 24" - 31"*

6013-18-15-526	18"	Full Round	3	Almond	Dependent	Included	\$60.79
6013-20-15-526	20"	Full Round	3	Almond	Dependent	Included	\$67.31
6013-18-11-526	18"	Full Round	3	White	Dependent	Included	\$60.79
6013-20-11-526	20"	Full Round	3	White	Dependent	Included	\$67.31

*Post adjusts from: 38" - 46"*

Polymer: 6072



Mfg. #	Size	Shape	Shelves	Finish	Rotation	Hardware	Each
6072-18-15-52	18"	Full Round	2	Almond	Independent	Included	\$72.48
6072-20-15-52	20"	Full Round	2	Almond	Independent	Included	\$82.84
6072-28-15-52	28"	Full Round	2	Almond	Independent	Included	\$102.56
6072-32-15-52	32"	Full Round	2	Almond	Independent	Included	\$107.96
6072-18-11-52	18"	Full Round	2	White	Independent	Included	\$72.48
6072-20-11-52	20"	Full Round	2	White	Independent	Included	\$82.84
6072-28-11-52	28"	Full Round	2	White	Independent	Included	\$102.56
6072-32-11-52	32"	Full Round	2	White	Independent	Included	\$107.96

*Post adjusts from: 26" - 32"*

Polymer: 6472



Mfg. #	Size	Shape	Shelves	Finish	Rotation	Hardware	Each
6472-18-15-52	18"	Kidney	2	Almond	Independent	Included	\$62.09
6472-24-15-52	24"	Kidney	2	Almond	Independent	Included	\$67.87
6472-28-15-52	28"	Kidney	2	Almond	Independent	Included	\$80.45
6472-32-15-52	32"	Kidney	2	Almond	Independent	Included	\$91.05
6472-18-11-52	18"	Kidney	2	White	Independent	Included	\$62.09
6472-24-11-52	24"	Kidney	2	White	Independent	Included	\$67.87
6472-28-11-52	28"	Kidney	2	White	Independent	Included	\$80.45
6472-32-11-52	32"	Kidney	2	White	Independent	Included	\$91.05

*Post adjusts from: 26" - 32"*

## LAZY SUSANS, CONT.



Polymer: 6472

Mfg. #	Size	Shape	Shelves	Finish	Rotation	Hardware	Each
4WLS072-28-52	28"	Full Round	2	Maple	Independent	Included	\$169.60
4WLS072-32-52	32"	Full Round	2	Maple	Independent	Included	\$193.58
<i>Post adjusts from: 26" - 31"</i>							
4WLS073-18-52	18"	Full Round	3	Maple	Independent	Included	\$157.99
4WLS073-20-52	20"	Full Round	3	Maple	Independent	Included	\$160.00
<i>Post adjusts from: 38" - 46"</i>							
4WLS472-28-52	28"	Kidney	2	Maple	Independent	Included	\$163.61
4WLS472-32-52	32"	Kidney	2	Maple	Independent	Included	\$193.74
4WLS882-32-570	28"	Half Moon	2	Maple	Independent	Included	\$199.97
4WLS882-35-570	32"	Half Back	2	Maple	Independent	Included	\$176.68
<i>Post adjusts from: 26" - 32"</i>							

## WASTE SYSTEMS



**RV-12PB**  
Single 35 qt. \$55.861  
Shown with Door Mount Kit Sold Separately  
10<sup>5</sup>/<sub>8</sub>" W x 22" D x 19<sup>1</sup>/<sub>4</sub>" H  
¾ Extension Slide

**RV-15PB-2S**  
Double 27 qt. \$75.55  
11<sup>13</sup>/<sub>16</sub>" W x 22<sup>1</sup>/<sub>4</sub>" D x 19<sup>1</sup>/<sub>8</sub>" H  
Full Extension Slide



**RV-18PB-2S**  
Double 35 qt. \$79.90



**Waste Container (White Only) Each**  
RV-1024W 27 QT. \$13.22  
RV-35-W 35 QT. \$7.95  
RV-50-W 50 QT. \$15.62

## REV-A-SHELF ACCESSORIES



**Trimnable Cutlery Tray**  
4WCT-1 14<sup>5</sup>/<sub>8</sub>" X 22" X 2<sup>1</sup>/<sub>8</sub>" \$27.43  
4WCT-3 20<sup>5</sup>/<sub>8</sub>" X 22" X 2<sup>1</sup>/<sub>8</sub>" \$36.24



Top 3 Shelf Depths 2<sup>3</sup>/<sub>8</sub>"  
Bottom Depths 4<sup>1</sup>/<sub>8</sub>"

**Wire Door Mount Spice Rack**  
565-10-52 10<sup>5</sup>/<sub>8</sub>" W X 21<sup>3</sup>/<sub>8</sub>" H \$25.44  
565-14-52 13<sup>5</sup>/<sub>8</sub>" W X 21<sup>3</sup>/<sub>8</sub>" H \$26.45



**Wood Door Mount Spice Rack**  
4SR-18 12<sup>5</sup>/<sub>8</sub>" W X 3<sup>1</sup>/<sub>8</sub>" D X 21" H \$32.60  
4SR-21 15<sup>5</sup>/<sub>8</sub>" W X 3<sup>1</sup>/<sub>8</sub>" D X 21" H \$36.97

## SINK FRONT (TIP-OUT TRAYS & HINGES)



**Poly Tip-Out Trays**  
6581-11-11-4 11" WHITE \$3.50  
6581-11-15-4 11" ALMOND \$3.50  
6581-14-11-4 14<sup>1</sup>/<sub>4</sub>" WHITE \$3.50  
6581-14-15-4 14<sup>1</sup>/<sub>4</sub>" ALMOND \$3.50



**Stainless Steel Tip-Out Trays**  
6581-14-5 14<sup>1</sup>/<sub>4</sub>" \$9.30  
6581-25-5 25" \$11.61  
6581-28-5 28" \$12.22  
6581-31-5 31" \$12.38



**Tip-Out Tray Hinges**

	Pairs per Box	1 Pair	12 Pairs
6552-0220-4	40 PAIRS	STD \$3.76	-
6552-ETH-10	10 PAIRS	EURO \$5.30	-
LD-0220-50SC	40 PAIRS	S/C \$10.50	\$9.76

# BASE CABINET FILLERS



PRODUCT	DESCRIPTION	DIMENSIONS	FINISH	SET PER CTN	WHT PER CARTON	PRICE
Base Filler Organizer (Individual Pack)						
<b>432-BF-3C</b>	3" Filler Organizer	3" W x 23" D x 30" H	Wood	1	21 lb.	\$92.46
<b>432-BF-6C</b>	6" Filler Organizer	6" W x 23" D x 30" H	Wood	1	33 lb.	\$111.67
<b>432-BF-9C</b>	9" Filler Organizer	9" W x 23" D x 30" H	Wood	1	47 lb.	\$152.32

# PULL-OUT BASE ORGANIZER



PRODUCT	DESCRIPTION	DIMENSIONS	FINISH	SET PER CTN	PRICE
Base Organizer (Individual Pack)					
<b>448-BC-5C</b>	Base Organizer	5" W x 22 <sup>3</sup> / <sub>8</sub> " D x 25 <sup>1</sup> / <sub>2</sub> " H	Wood	1	\$107.96
<b>448-BC-8C</b>	Base Organizer	8" W x 22 <sup>3</sup> / <sub>8</sub> " D x 25 <sup>1</sup> / <sub>2</sub> " H	Wood	1	\$123.57

# REV•A•LOCK® CABINET LOCK SECURITY SYSTEM



PRODUCT	DESCRIPTION	FINISH	SET PER CTN	WHT PER CARTON	PRICE
Rev-A-Lock Cabinet Security (Components)					
<b>RAL-101-1</b>	Starter Set (5 Locks & 2 Keys)	White Polymer	1	1 lb.	\$31.35
<b>RL-201-1</b>	Lock Assembly	White Polymer	25	3 lb.	\$5.22
<b>RL-202-1</b>	Magnetic Key	White Polymer	25	2 lb.	\$7.23

# SERGER / MIXER LIFT



REVERED AS THE "BEST IN THE INDUSTRY", THIS HEAVY-DUTY LIFT PROVIDES MECHANICAL ASSIST AND FEATURES BUILT-IN SHOCK DAMPENERS, ADJUSTABLE SPRING TENSION AND HOLDS APPLIANCES UP TO 60 LBS. CAN BE ATTACHED TO ANY CUSTOM MADE SHELF AND WILL FIT ALL CABINET SIZES.

**RV-RAS-ML-HDCR**  
HEAVY-DUTY MIXER LIFT

**RV-RAS-ML-HDSC**  
HEAVY-DUTY MIXER LIFT WITH SOFT CLOSE

ITEM	1+
<b>RV-RAS-ML-HDCR</b>	\$89.15
<b>RV-RAS-ML-HDSC</b>	\$153.38

# POLYMER CUTLERY TRAYS

Product	Description	Dims	Min Trim	Finish	Price
<b>CT-1*-52</b>	Cutlery Tray	11-1/2" (293 mm) W x 21-1/4" (540 mm) D x 2-3/8" (61 mm) H	8-5/8" (219 mm) W x 17-3/4" (451 mm) D	Polymer	\$11.65
<b>CT-2*-52</b>	Cutlery Tray	14-1/4" (362 mm) W x 21-1/4" (540 mm) D x 2-3/8" (61 mm) H	11-5/8" (296 mm) W x 17-3/4" (451 mm) D	Polymer	\$12.65
<b>CT-3*-52</b>	Cutlery Tray	17-1/2" (445 mm) W x 21-1/4" (540 mm) D x 2-3/8" (61 mm) H	14-3/4" (375 mm) W x 17-3/4" (451 mm) D	Polymer	\$14.70
<b>CT-4*-52</b>	Cutlery Tray	27-7/8" (556 mm) W x 21-1/4" (540 mm) D x 2-3/8" (61 mm) H	18-3/4" (467 mm) W x 17-3/4" (451 mm) D	Polymer	\$15.70

\* - Insert (w) for White, (A) for Almond, and (S) for Metallic Silver. Add "G" to the beginning of the product number to designate Glossy finish.



**CT-1A-52**  
Polymer Cutlery Tray  
(Almond finish shown)



**GCT-2S-52**  
Polymer Cutlery Tray  
(Metallic Silver finish shown)



**CT-4W-52**  
Polymer Cutlery Tray  
(White finish shown)

# POLYMER UTENSIL TRAYS

Product	Description	Dims	Min Trim	Finish	Price
<b>UT-10*-52</b>	Utensil Trays	11-1/2" (293 mm) W x 21-1/4" (540 mm) D x 2-3/8" (61 mm) H	8-5/8" (219 mm) W x 17-3/4" (451 mm) D	Polymer	\$11.97
<b>UT-12*-52</b>	Utensil Trays	14-1/4" (362 mm) W x 21-1/4" (540 mm) D x 2-3/8" (61 mm) H	11-5/8" (296 mm) W x 17-3/4" (451 mm) D	Polymer	\$13.13
<b>UT-15*-52</b>	Utensil Trays	17-1/2" (445 mm) W x 21-1/4" (540 mm) D x 2-3/8" (61 mm) H	14-3/4" (375 mm) W x 17-3/4" (451 mm) D	Polymer	\$13.39
<b>UT-18*-52</b>	Utensil Trays	27-7/8" (556 mm) W x 21-1/4" (540 mm) D x 2-3/8" (61 mm) H	18-3/4" (467 mm) W x 17-3/4" (451 mm) D	Polymer	\$14.05

\* - Insert (w) for White, (A) for Almond. Add "G" to the beginning of the product number to designate Glossy finish.



**UT-10A-51**  
Polymer Utensil Tray  
(Almond finish shown)



**UT-12A-52**  
Polymer Utensil Tray  
(Almond finish shown)



**GUT-15W-52**  
Polymer Utensil Tray  
(White finish shown)

# TOWEL HOLDERS

Product	Description	Dims	MCO	CAB	Finish	Price
<b>Door Mount Towel Holder</b>						
<b>563-32</b>	Towel Holder	12-3/4" (324 mm) W x 3-1/2" (89 mm) D x 6-1/2" (165 mm) H	12-3/4"	SB30	White	\$3.13
<b>563-32 C</b>	Towel Holder	12-3/4" (324 mm) W x 3-1/2" (89 mm) D x 6-1/2" (165 mm) H	12-3/4"	SB30	Chrome	\$3.39
<b>Pullout Towel Holder</b>						
<b>563-51 C</b>	2 Prong Towel Holder	3-7/8" (99 mm) W x 12-7/8" (327 mm) D x 1-1/2" (38 mm) H			Chrome	\$12.22
<b>563-47</b>	3 Prong Towel Holder	5" (127 mm) W x 17-3/4" (451 mm) D x 1-1/4" (32 mm) H			White	\$16.44
<b>563-47 C</b>	3 Prong Towel Holder	5" (127 mm) W x 17-3/4" (451 mm) D x 1-1/4" (32 mm) H			Chrome	\$18.26



**563-32 C**  
Door Mount Towel Holder  
(Chrome finish shown)



**563-47 C**  
3 Prong Pullout Towel Holder  
(Chrome finish shown)

## TIP OUT TRAY: STAINLESS STEEL

- CONVERT FALSE FRONT DOORS INTO USEFUL HIDDEN STORAGE SPACE
- SOLD AS INDIVIDUAL TRAYS
- STAINLESS STEEL IS DURABLE AND EASILY CLEANED
- 1-9/16" SLIM DEPTH TRAYS ARE GREAT FOR USE IN LOW CLEARANCE APPLICATIONS BEHIND LARGE SINKS



- TOSS11-REPL**  
11" W X 2" D X 3" H - 1 Tray
- TOSS11S-REPL**  
11" W X 1-9/16" D X 3" H - 1 Tray
- TOSS14-REPL**  
14" W X 2" D X 3" H - 1 Tray
- TOSS14S-REPL**  
14" W X 1-9/16" D X 3" H - 1 Tray

ITEM	1+
<b>TOSS11-REPL</b>	\$10.07
<b>TOSS11S-REPL</b>	\$9.71
<b>TOSS14-REPL</b>	\$10.73
<b>TOSS14S-REPL</b>	\$10.44



## SINK FRONT TRAYS & HINGES

- TRAYS ARE MADE WITH HIGH QUALITY IMPACT RESISTANT PLASTIC



- T011S-REPL**  
3" H X 11" W X 1 9/16" D  
WHITE
- T014S-REPL**  
3" H X 14" W X 1 9/16" D  
WHITE

- DESIGNED FOR USE W/ SCISSOR OR EURO-TRAY HINGES

ITEM	1+	12+
<b>T011S-REPL</b>	\$5.50	----
<b>T014S-REPL</b>	\$6.50	----
<b>T011-REPL</b>	\$5.50	\$4.95
<b>T014-REPL</b>	\$5.75	\$5.00
<b>SFT-112-S</b>	\$5.50	\$4.95
<b>SFT-142-S</b>	\$5.75	\$5.00
<b>TH-270</b>	\$6.50	\$6.25
<b>TH-1164</b>	\$4.95	\$4.50
<b>TH-0220-SC</b>	\$10.50	\$9.76



- T011-REPL**  
3" H X 11" W X 2" D
- T014-REPL**  
3" H X 14" W X 2" D



- SFT-112-S**  
3" H X 11" W X 2" D
- SFT-142-S**  
3" H X 14" W X 2" D



- TH-1164**  
2 3/4" H X 4" W X 2" D
- ANGLE OPENING ADJUSTABLE FROM 45-90 DEGREES
- 32MM HOLE SPACING
- PLATE MOUNTING



- TH-270**  
3 3/4" H X 3 3/4" W X 1 3/4" D
- SMOOTH, RELIABLE OPERATION
- POLY BAGGED PER SET WITH SCREWS



- TH-0220-SC**  
3 7/8" H X 2 5/8" W
- 50 DEGREE SOFT CLOSE HINGE

## COOKBOOK RACK

- CLEAR PLASTIC PULL DOWN TRAY AND SCISSOR HINGE
- FITS UNDER CABINET 24" AND WIDER



- UCCB**  
3" H X 19 3/4" W X 10" D



- COOKBOOK RACK HINGE**  
**CBRH-1**

ITEM	1+	10+
<b>CBRH-1</b>	\$13.95/PR	\$10.95/PR
<b>UCCB</b>	\$110.00	-



**TASK**  
lighting

# *Lighting*

A thick yellow arc that starts above the letter 'L' and curves over the word 'Lighting'.

**TASK**  
lighting

The logo for TASK lighting, featuring the word 'TASK' in a bold, sans-serif font with a yellow arc over it, and the word 'lighting' in a smaller, lowercase sans-serif font below it.

*Shemol*

## VIVID SERIES TAPE LIGHT

- HIGH LIGHT OUTPUT – 225 LUMENS PER FOOT (738/M) AT 3000K
- 3 WATTS PER FOOT (9.85/M), 48 WATTS PER 16 FOOT ROLL (5M)
- KELVIN TEMPERATURE OPTIONS: WARM WHITE (2700K), SOFT WHITE (3000K), COOL WHITE (4000K), DAYLIGHT WHITE (5000K)
- 12V DC PLUG-IN OR HARDWIRED POWER SUPPLY (ORDER SEPARATELY)
- 36 DIODES PER FOOT
- 16 FOOT ROLL OF TAPE LIGHT – CUTTABLE EVERY 1"
- 90 CRI
- DIMMABLE (WITH COMPATIBLE DIMMER)
- 30,000 HOUR LED LIFE AT 70% LUMEN MAINTENANCE
- NO ULTRAVIOLET (UV) OR INFRARED (IR)
- PROTECTIVE MICRO WATERPROOF COATING – IP65 RATED
- 3M™ 300LSE WATERPROOF ADHESIVE TAPE



ITEM	KELVIN TEMPERATURE OPTIONS	BROKEN ROLL	1 ROLL	5 ROLLS
L-VMW600-16-27	WARM WHITE	\$4.71/FT	\$64.69	\$58.22
L-VMW600-16-30	SOFT WHITE	\$4.71/FT	\$64.69	\$58.22
L-VMW600-16-40	COOL WHITE	\$4.71/FT	\$64.69	\$58.22
L-VMW600-16-50	DAYLIGHT WHITE	\$4.71/FT	\$64.69	\$58.22

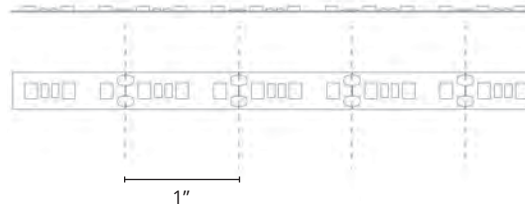

## RADIANCE SERIES TAPE LIGHT

- MEDIUM LIGHT OUTPUT – 120 LUMENS PER FOOT (395/M) AT 3000K
- 2 WATTS PER FOOT (4.93/M), 32 WATTS PER 16 FOOT ROLL (5M)
- KELVIN TEMPERATURE OPTIONS: WARM WHITE (2700K), SOFT WHITE (3000K), COOL WHITE (4000K), DAYLIGHT WHITE (5000K)
- 12V DC PLUG-IN OR HARDWIRED POWER SUPPLY (ORDER SEPARATELY)
- 18 DIODES PER FOOT
- 16 FOOT ROLL OF TAPE LIGHT – CUTTABLE EVERY 2"
- 90 CRI
- DIMMABLE (WITH COMPATIBLE DIMMER)
- 30,000 HOUR LED LIFE AT 70% LUMEN MAINTENANCE
- NO ULTRAVIOLET (UV) OR INFRARED (IR)
- PROTECTIVE MICRO WATERPROOF COATING – IP65 RATED
- 3M™ 300LSE WATERPROOF ADHESIVE TAPE



ITEM	KELVIN TEMPERATURE OPTIONS	BROKEN ROLL	1 ROLL	5 ROLLS
L-RMW300-16-27	WARM WHITE	\$3.19/FT	\$43.90	\$39.50
L-RMW300-16-30	SOFT WHITE	\$3.19/FT	\$43.90	\$39.50
L-RMW300-16-40	COOL WHITE	\$3.19/FT	\$43.90	\$39.50
L-RMW300-16-50	DAYLIGHT WHITE	\$3.19/FT	\$43.90	\$39.50

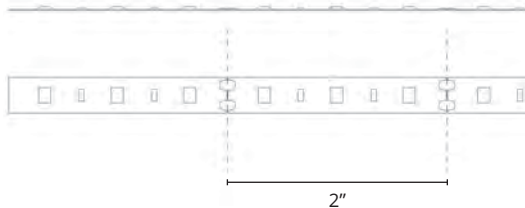

## VIVID SERIES KITS

- (1) 16 FT. ROLL VIVID SERIES LED TAPE LIGHT 4000K WARM WHITE
- (1) TOUCH DIMMER SWITCH
- (1) 60 WATT 12V DC POWER SUPPLY
- 25 FT. ROLL CONNECTION WIRE
- LED TAPE LIGHT TO WIRE CONNECTORS (6 PIECES)



ITEM	KELVIN TEMPERATURE OPTIONS	1 KIT	5 KITS
L-VTDK-16-30	SOFT WHITE	\$125.00	\$120.00
L-VTDK-16-40	COOL WHITE	\$125.00	\$120.00

## RADIANCE SERIES KITS

- (1) 16 FT. ROLL VIVID SERIES LED TAPE LIGHT 3000K WARM WHITE
- (1) TOUCH DIMMER SWITCH
- (1) 24 WATT 12V DC POWER SUPPLY
- 25 FT. ROLL CONNECTION WIRE
- LED TAPE LIGHT TO WIRE CONNECTORS (6 PIECES)



ITEM	KELVIN TEMPERATURE OPTIONS	1 KIT	5 KITS
L-RTDK-16-30	SOFT WHITE	\$99.00	\$95.00
L-RTDK-16-40	COOL WHITE	\$99.00	\$95.00



## PEARL SERIES PUCK LIGHT

- MEDIUM LIGHT OUTPUT – 205 LUMENS PER FIXTURE AT 3000K
- 3 WATTS PER FIXTURE
- KELVIN TEMPERATURE OPTIONS: WARM WHITE (2700K), SOFT WHITE (3000K), COOL WHITE (4000K), DAYLIGHT WHITE (5000K)
- RECESS OR SURFACE MOUNT
- INCLUDES TWO LENSES, FROSTED AND CLEAR
- 12V DC PLUG-IN OR HARDWIRED POWER SUPPLY (ORDER SEPARATELY)
- 90 CRI
- DIMMABLE (WITH COMPATIBLE DIMMER)
- 30,000 HOUR LED LIFE AT 70% LUMEN MAINTENANCE
- NO ULTRAVIOLET (UV) OR INFRARED (IR)
- 3 FOOT LEAD WITH END BARREL CONNECTOR

ITEM	KELVIN TEMPERATURE OPTIONS	1+	10+	25+
L-PS-FR-3-27	WARM WHITE	\$20.58	\$18.95	\$17.75
L-PS-FR-3-30	SOFT WHITE	\$20.58	\$18.95	\$17.75
L-PS-FR-3-40	COOL WHITE	\$20.58	\$18.95	\$17.75
L-PS-FR-3-50	DAYLIGHT WHITE	\$20.58	\$18.95	\$17.75

**TASK** lighting

**L-PS-FR-3-30**  
BLACK FIXTURE SHOWN



BLACK



BRONZE



BRUSHED ALUMINUM



WHITE



PLEASE SPECIFY COLOR WHEN ORDERING

## CONSTANT VOLTAGE POWER SUPPLIES



ITEM	WATT	1+	10+	25+
T-12W-12V-PI	12 WATT	\$13.30	\$12.41	\$11.88
T-24W-12V-PI	24 WATT	\$14.44	\$13.92	\$12.89
T-36W-12V-PI	36 WATT	\$19.36	\$18.06	\$17.08
T-60W-12V-PI	60 WATT	\$28.31	\$26.42	\$24.53
T-96W-12V-PI	96 WATT	\$37.16	\$34.50	\$33.18



WIRING FOR CONSTANT VOLTAGE POWER SUPPLIES



## SWITCHES AND SENSORS

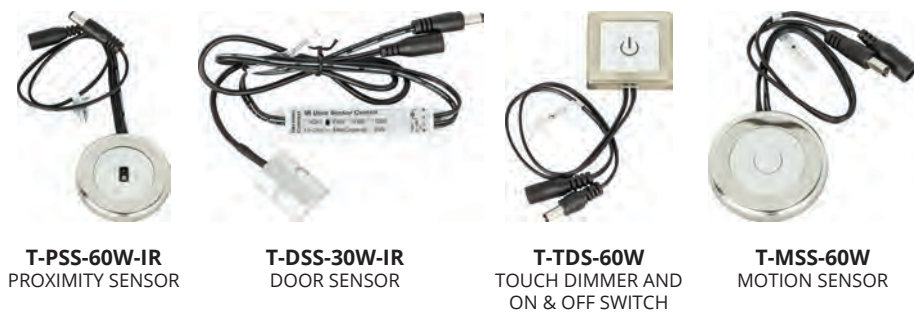

ITEM	1+	10+	25+
T-PSS-60W-IR	\$20.55	\$19.18	\$17.81
T-DSS-30W-IR	\$11.02	\$10.28	\$9.79
T-TDS-60W	\$10.68	\$9.92	\$9.54
T-MSS-60W	\$8.89	\$8.29	\$7.90

## DIMMING COMPONENTS FOR TAPE OR PUCK LIGHT



ITEM	DESCRIPTION	1+
T-Q-WR96	96 WATT WIRELESS RECEIVER	\$36.28
T-Q-WR240	240 WATT WIRELESS RECEIVER	\$48.45
T-Q-4Z-WC-RF	4 ZONE WIRELESS CONTROLLER	\$36.28



## ALUMINUM HOUSINGS WITH FROSTED LENS

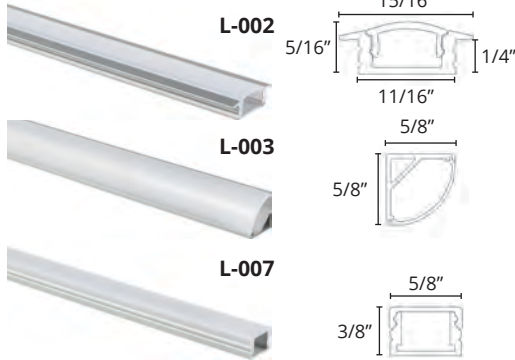

ITEM	DESCRIPTION	1+	10+	25+
L-002-FR-48	48" RECESS ALUMINUM HOUSING	\$5.83	\$5.44	\$5.05
L-003-FR-48	48" ANGLED ALUMINUM HOUSING	\$10.56	\$9.85	\$9.15
L-003-FR-80	80" ANGLED ALUMINUM HOUSING	\$22.22	\$20.74	\$19.26
L-007-FR-48	48" FLAT ALUMINUM HOUSING	\$10.56	\$9.85	\$9.15
L-007-FR-80	80" FLAT ALUMINUM HOUSING	\$17.50	\$16.34	\$15.17
L-EC-002	END CAPS FOR L-002	\$1.22	\$1.13	\$1.05
L-EC-003	END CAPS FOR L-003	\$1.22	\$1.13	\$1.05
L-MC-003	MOUNTING CLIP FOR L-003	\$0.85	\$0.78	\$0.75
L-MC-007	MOUNTING CLIP FOR L-007	\$0.85	\$0.78	\$0.75



## WIRES AND ACCESSORIES

ITEM	DESCRIPTION	1+	25+
T-CW20	0GA STANDARD CONNECTION WIRE (PER FT.)	\$0.05	\$0.03
T-EZWC	EZ WIRE TO WIRE CONNECTOR	\$0.32	\$0.26
L-8MM-EZ	8MM EZ CONNECTOR	\$1.69	\$1.38
L-8MM-SC	8MM SPLICE SNAP CONNECTOR	\$1.25	\$1.08
L-8MM-WTSC	8MM LED TAP LIGHT TO WIRE CONNECTOR	\$1.25	\$1.08
T-3WSP	DC 3-WAY SPLITTER PLUG	\$5.10	\$4.42
T-MBC	MALE BARREL TO CONDUCTOR SCREW DOWN CONNECTOR	\$1.85	\$1.60
T-FBC	FEMALE BARREL TO CONDUCTOR SCREW DOWN CONNECTOR	\$1.85	\$1.60
T-BC-EXT-36-BK	36" LEAD WIRE WITH BARREL CONNECTOR	\$6.49	\$6.01
T-BC-EXT-72-BK	72" LEAD WIRE WITH BARREL CONNECTOR	\$8.36	\$7.74
T-BC-EXT-96-BK	96" LEAD WIRE WITH BARREL CONNECTOR	\$11.65	\$10.79

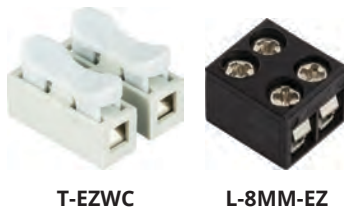

### EXAMPLE – Basic Kit Hookup Diagram

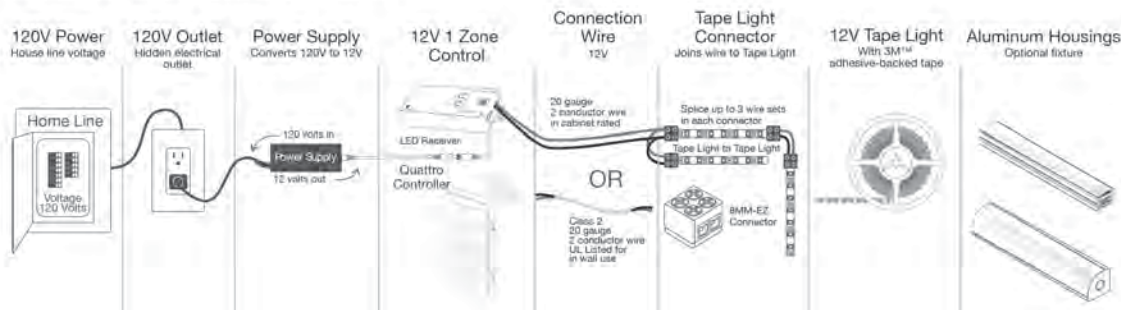

## SHEMOI ENTERPRISES CAN LIGHTS

- SIMPLE SPRING CLIP MOUNTING - PUSH THROUGH 3 3/4" HOLES
- INCLUDES 40 WATT REFLECTIVE BULB
- CAN DIMENSIONS 3 1/4" DIA, 3" H W/ A 5/8" FLANGE
- REQUIRES 3 1/2" CLEARANCE FOR DOUBLE TOP HUTCHES
- USE W/ TOUCH DIMMER ON NEXT PAGE

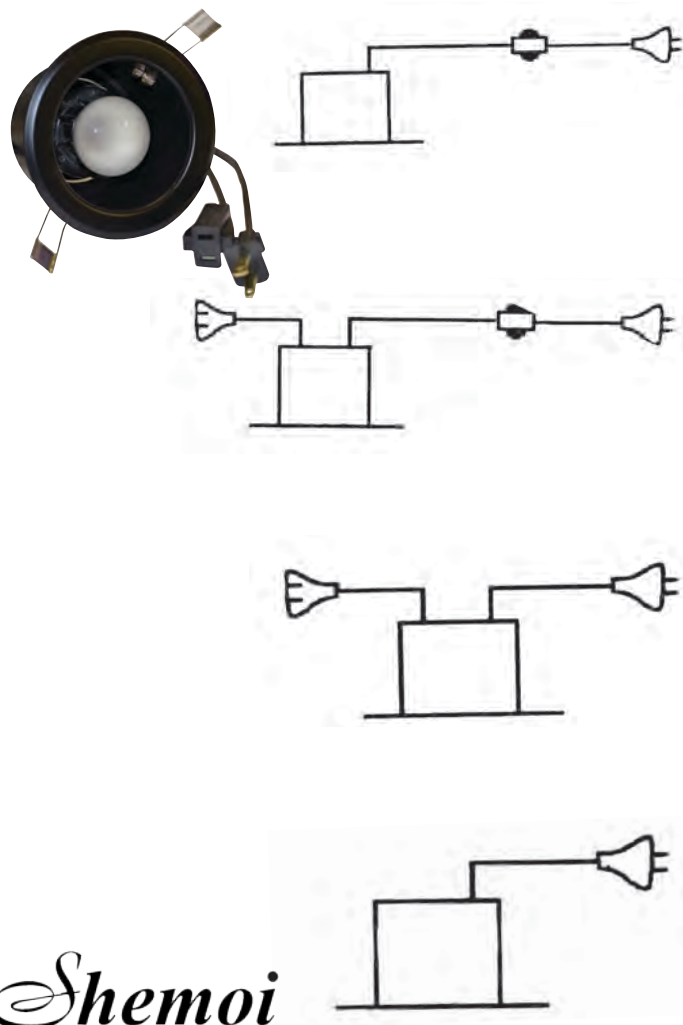

*Shemoui*

- SINGLE CAN**
- 10 FT CORD
  - ROLL SWITCH

ITEM	COLOR	1+	25+	50+
CL35B	ANTIQUE ENGLISH	\$11.46	\$10.67	\$9.48
CL351B	POLISHED BRASS	\$11.46	\$10.67	\$9.48
CL352B	BLACK	\$11.46	\$10.67	\$9.48
CL353B	CHROME	\$11.46	\$10.67	\$9.48

- CL35 STARTER CAN**
- 10 FT CORD
  - ROLL SWITCH
  - 18" FEMALE CORD

ITEM	COLOR	1+	25+	50+
CL35	ANTIQUE ENGLISH	\$12.76	\$11.88	\$10.56
CL351	POLISHED BRASS	\$12.76	\$11.88	\$10.56
CL352	BLACK	\$12.76	\$11.88	\$10.56
CL353	CHROME	\$12.76	\$11.88	\$10.56

- CL35A MIDDLE CAN**
- 18" MALE & FEMALE CORD

ITEM	COLOR	1+	25+	50+
CL35A	ANTIQUE ENGLISH	\$11.25	\$10.25	\$8.60
CL351A	POLISHED BRASS	\$11.25	\$10.25	\$8.60
CL352A	BLACK	\$11.25	\$10.25	\$8.60
CL353A	CHROME	\$11.25	\$10.25	\$8.60

- END CAN**
- 18" MALE CORD

ITEM	COLOR	1+	25+	50+
CL36	ANTIQUE ENGLISH	\$10.25	\$9.40	\$7.95
CL361	POLISHED BRASS	\$10.25	\$9.40	\$7.95
CL362	BLACK	\$10.25	\$9.40	\$7.95
CL363	CHROME	\$10.25	\$9.40	\$7.95

## REPLACEMENT BULBS



**CLB40N**

- FITS BOTH SHEMOI & SPECIALTY BRAND LIGHTS
- AVAILABLE IN 25 WATT OR 40 WATT



**CLB348**



**LHR-16D**

LED REPLACEMENT BULB FOR SHEMOI OR SPECIALTY CAN LIGHTS

- 25,000 HRS
- 5 WATTS
- WARM WHITE

ITEM	1+	25+
CLB40N	\$2.25	\$1.99
CLB348	\$1.50	\$1.35
LHR-16D	\$9.95	\$8.50



## LOW VOLTAGE ACCENT LIGHTS



### WTER1-BL

- RECESSED OR SURFACE MOUNTING
- SOFT START ELECTRONIC SAFETY TRANSFORMER
- 10' CORD WITH MOLDED PLUG AND ROLL SWITCH
- TERMINAL BLOCK ON 24" LEAD
- UL LISTED
- USE W/ TOUCH DIMMERS BELOW
- AVAILABLE IN SETS OF 2 OR 3 COMPLETE KITS
- BRASS OR BLACK

WORKS WITH **CL9** DIMMER



### CL1120

- FOR HALOGEN 20 WATT

ITEM	# OF LIGHTS	COLOR	1+ SETS	10+ SETS
<b>WTER1-BL</b>	1	BLACK	\$24.50	\$22.00
<b>WTER1-BR</b>	1	BRASS	\$25.50	\$23.00
<b>WTER2-BL</b>	2	BLACK	\$35.95	\$32.35
<b>WTER2-BR</b>	2	BRASS	\$39.40	\$35.45
<b>WTER3-BL</b>	3	BLACK	\$48.75	\$47.50
<b>WTER3-BR</b>	3	BRASS	\$49.00	\$48.17

ITEM	1+
<b>CL1120</b>	\$3.50

## LED ACCENT LIGHTS

- RECESSED OR SURFACE MOUNTING
- SOFT START ELECTRONIC SAFETY TRANSFORMER
- 10' CORD WITH MOLDED PLUG AND ROLL SWITCH
- TERMINAL BLOCK ON 24" LEAD
- UL LISTED
- USE W/ TOUCH DIMMERS BELOW
- AVAILABLE IN SETS OF 2 OR 3 COMPLETE KITS
- BRASS OR BLACK



ITEM	# OF LIGHTS	COLOR	1+ SETS	10+ SETS
<b>LED25-1-BL</b>	1	BLACK	\$24.50	\$22.00
<b>LED25-1-BR</b>	1	BRASS	\$25.50	\$23.00
<b>LED25-2-BL</b>	2	BLACK	\$35.95	\$32.35
<b>LED25-2-BR</b>	2	BRASS	\$39.40	\$35.45
<b>LED25-3-BL</b>	3	BLACK	\$48.75	\$47.50
<b>LED25-3-BR</b>	3	BRASS	\$49.00	\$48.00

WORKS WITH **CL9-LED** DIMMER

## CABINET + CURIO LIGHTS



### DETACHABLE PLUG CL2

- USE W/ ANY LIGHT W/ MOLDED PLUG, ONLY REQUIRES A HOLE THE SIZE OF THE CORD



### SINGLE CURIO LIGHT CL4

- 10' CORD
- MOLDED ON PLUG
- BROWN
- HALF SHADE



### PICTURE CURIO LIGHT CL6

- 10' CORD
- 3' 4" WRAP SHADE IN POLISHED BRASS



### SINGLE CURIO LIGHT CL3

8" X 2 1/4"

- 10' POWER CORD W/ 18" FEMALE CORD
- USE WHEN CONNECTING TWO LIGHTS TOGETHER
- BROWN
- HALF SHADE



### DOUBLE CURIO & HUTCH LIGHT W/ MOLDED ON PLUG CL8

15 1/2" X 2 3/8"

- BROWN

ITEM	1+	50+
<b>CL2</b>	\$0.75	\$0.65
<b>CL3</b>	\$7.50	\$6.50
<b>CL4</b>	\$5.75	\$5.00
<b>CL6</b>	\$7.75	\$6.95
<b>CL8</b>	\$10.95	\$9.95

## TOUCH DIMMERS



**SHEMOI TOUCH DIMMER  
CL9**

- WORKS WITH SHEMOI & SPECIALTY CAN LIGHTS
- 3 STAGE TOUCH DIMMERS



**TOUCH DIMMER  
CL9-LED**

- USE FOR ACCENT LED LIGHTS

ITEM	1+	25+	50+
<b>CL9</b>	\$14.50	\$13.95	\$11.95
<b>CL9-LED</b>	\$19.99	\$18.99	\$18.25

## TELEPHONE & MODEM POWER STATIONS



**PS3-2F**

- POWER STATION
- EASY MOUNTING
- RECESS IN MOUNTING HOLE 4 1/4" DIAMETER
- OUTSIDE DIAMETER 4 3/8"
- THREE GROUNDED OUTLETS
- 10' POWER CORD
- TWO COMBS STYLE JACKS
- UNIVERSAL FOR BOTH RJ45 HIGH SPEED & RJ11 MODEM CONNECTION



**PG1-2U**

- 80MM HOLE SIZE



**WPC-1**

- WIRELESS PHONE CHARGER
- BLACK
- 2 7/16" RECESS HOLE 7/16" DEEP
- OUTPUT 9V, 2A, 10W
- INPUT 100-240V

ITEM	1+	10+
<b>PS3-2F</b>	\$29.00	\$25.50
<b>PG1-2U</b>	\$29.95	\$24.50
<b>WPC-1</b>	\$21.95	\$19.95

## TELEPHONE & MODEM HARNESSSES

- POWER AND COMMUNICATIONS HARNESSSES DESIGNED FOR USE IN WALL UNITS, ENTERTAINMENT CENTERS, HOME OFFICE FURNITURE, OR WHEREVER THERE IS A NEED FOR A PERMANENTLY INSTALLED HARNESS WITH MULTIPLE OUTLETS, PHONE JACK OR COAXIAL CABLE FOR TV CONNECTION



**PB2-2U**

1 13/16" X 4 7/8"

- RECESS MOUNT
- FITS IN 1-11/16" X 3-3/4" HOLE
- 2 OUTLET - 2 USB
- 9' GROUNDED POWER CORD



FRONT



BACK

**WPC52T**

1 7/8" X 9 1/2"

- RECESS MOUNTED HARNESS
- 5 GROUNDED OUTLETS W/ SURGE PROTECTION
- CAN BE INDIVIDUALLY SWITCHED ON/OFF
- INCLUDES OUTLET FOR ADAPTER PLUG
- 13 AMP CAPACITY
- 2 TELEPHONE/MODEM JACKS
- 2 X 14 FT LINE CORD
- 10 FT GROUNDED POWER CORD



**PB2-2U-HD**

1 13/16" X 4 7/8"

- RECESS MOUNT
- BLACK
- FITS IN 1-13/16" X 5-3/16" HOLE
- 2 OUTLET - 2 USB
- USB OUTPUT: 5V, 2.1A
- 9' GROUNDED POWER CORD

ITEM	1+	10+
<b>PB2-2U</b>	\$19.95	\$17.95
<b>PB2-2U-HD</b>	\$24.95	\$21.50
<b>WPC52T</b>	\$27.50	-

## DOWELS

LENGTH	1/8" D	3/16" D	1/4" D	5/16" D	3/8" D	7/16" D	1/2" D	5/8" D	3/4" D	7/8" D	1" D	1 1/8" D	1 1/4" D
36"	\$0.23	\$0.25	\$0.34	\$0.37	\$0.40	\$0.50	\$0.55	\$0.80	\$1.04	\$1.35	\$1.65	\$2.00	\$2.75
48"	\$0.30	\$0.37	\$0.43	\$0.46	\$0.48	\$0.56	\$0.74	\$1.00	\$1.55	\$1.80	\$2.25	\$2.55	\$3.20

LENGTH	WOOD	1/4" D	3/8" D	1/2" D	5/8" D	3/4" D	7/8" D	1" D	1 1/8" D	1 1/4" D
36"	OAK	\$0.48	\$0.51	\$0.90	\$1.20	\$1.81	\$1.89	\$2.35	\$3.20	\$4.05
36"	CHERRY	\$1.00	\$1.30	\$1.89	\$2.05	\$3.04	\$3.50	\$4.00	\$6.00	\$6.15
48"	OAK	\$0.58	\$0.74	\$1.15	\$1.70	\$2.15	\$2.94	\$3.04	\$4.10	\$5.10
48"	CHERRY	\$1.53	\$1.82	\$2.49	\$3.44	\$4.14	\$5.15	\$5.49	\$7.20	\$8.75

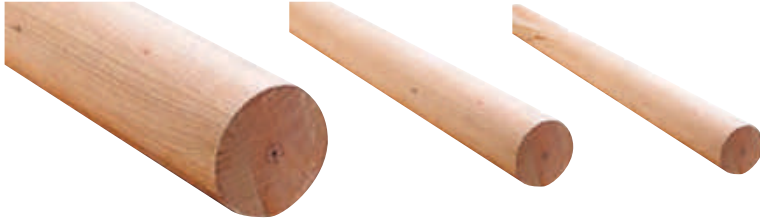

### QUALITY HARDWOOD DOWELS

POPLAR  
36" & 48" L

■ SANDED & READY TO USE

### QUALITY HARDWOOD DOWELS

OAK & CHERRY  
36" & 48" L

■ SANDED & READY TO USE

## ROPE TWIST HALF ROUNDS

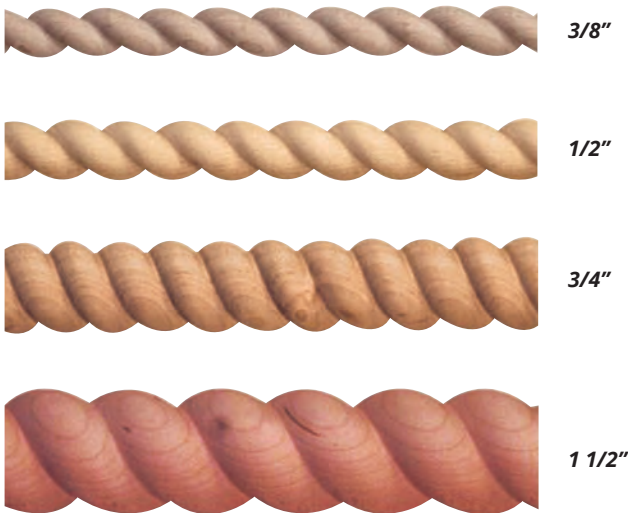

WOOD	DIA	1+ (4FT)	1+ (8FT)	10+ (8FT)
OAK	3/8"	\$5.25	\$10.52	\$9.14
MAPLE	3/8"	\$6.39	\$12.78	\$11.11
CHERRY	3/8"	\$6.63	\$13.25	\$11.52
POPLAR	3/8"	\$4.44	\$8.88	\$7.72
OAK	1/2"	\$4.80	\$9.61	\$8.35
MAPLE	1/2"	\$5.19	\$10.38	\$9.03
CHERRY	1/2"	\$6.03	\$12.07	\$10.49
POPLAR	1/2"	\$4.37	\$8.73	\$7.59
OAK	3/4"	\$5.01	\$10.03	\$8.71
MAPLE	3/4"	\$5.59	\$11.18	\$9.72
CHERRY	3/4"	\$6.18	\$12.37	\$10.75
POPLAR	3/4"	\$4.49	\$8.99	\$7.81
OAK	1 1/2"	\$19.83	\$39.65	\$34.58
MAPLE	1 1/2"	\$25.55	\$51.10	\$44.43
CHERRY	1 1/2"	\$25.87	\$51.74	\$44.99
POPLAR	1 1/2"	\$16.20	\$32.40	\$28.16

## FLUTED GLUE PINS



ITEM	PER 1,000	FULL CASE QTY	CASE PRICE
GPF 1/4" X 1 1/2"	\$13.95	25,000 PC	\$10.95/M
GPF 1/4" X 2"	\$13.95	25,000 PC	\$12.95/M
GPF 3/8" X 1 1/4"	\$14.50	13,000 PC	\$10.95/M
GPF 3/8" X 1 1/2"	\$17.50	13,000 PC	\$14.95/M
GPF 3/8" X 1 3/4"	\$18.00	13,000 PC	\$15.25/M
GPF 3/8" X 2"	\$18.00	13,000 PC	\$15.95/M

OTHER SIZES AVAILABLE ON REQUEST IN FULL CASE LOTS. PLEASE CALL FOR PRICES.

SMALL CARVINGS



**C203-O**  
OAK  
2" DIA  
**C203-C**  
CHERRY  
2" DIA



**C212-O**  
OAK  
2" SQ  
**C212-C**  
CHERRY  
2" SQ

ITEM	1+	50+	100+
<b>C203-O</b>	\$1.50	\$1.25	\$1.15
<b>C203-C</b>	\$1.75	\$1.35	\$1.25
<b>C212-O</b>	\$2.00	\$1.50	----
<b>C212-C</b>	\$2.50	\$2.25	----



**C209-O**  
OAK  
4 1/2" X 1 3/8"

ITEM	PAIRS	1+	25+
<b>C209-O</b>	PAIRS	\$2.50	\$2.20

MEDIUM CARVINGS



**C225-O**  
OAK  
7" X 3" EACH

ITEM	SOLD IN	1+	50+	100+
<b>C225-O</b>	PAIRS	\$3.85	\$3.60	-
<b>C608-O</b>	PAIRS	\$3.50	\$2.95	\$2.40
<b>C608-C</b>	PAIRS	\$3.95	\$3.55	\$3.25



**C608-O**  
OAK  
6" X 2 1/2" EACH  
**C608-C**  
CHERRY  
6" X 2 1/2" EACH



ITEM	1+
<b>C218-O</b>	\$2.95
<b>C218-C</b>	\$2.57

**C218-O**  
OAK  
5" X 5"  
**C218-C**  
CHERRY  
5" X 5"

LARGE CARVINGS



**C207-O**  
OAK  
14" L X 4 1/4" H  
**C207-C**  
CHERRY  
14" L X 4 1/4" H

ITEM	1+	25+	50+
<b>C207-O</b>	\$4.25	\$3.95	-
<b>C207-C</b>	\$4.60	\$4.50	-
<b>C211-O</b>	\$4.25	\$3.96	-
<b>C211-C</b>	\$4.60	\$4.30	-
<b>C215-O</b>	\$3.85	\$3.60	-
<b>C215-C</b>	\$3.95	\$3.25	\$3.00



**C215-O**  
OAK  
9 1/4" L X 2" H  
**C215-C**  
CHERRY  
9 1/4" L X 2" H



**C211-O**  
OAK  
9" X 2 1/8" EACH  
**C211-C**  
CHERRY  
9" X 2 1/8" EACH

## FINIAL



**OAF1**  
OAK  
3" H, 1 3/4" DIA, 3/8" TENON

**OAF2**  
CHERRY  
3" H, 1 3/4" DIA, 3/8" TENON

**OAF3**  
HICKORY  
3" H, 1 3/4" DIA, 3/8" TENON

**OAF4**  
MAPLE  
3" H, 1 3/4" DIA, 3/8" TENON

ITEM	1+	50+
<b>OAF1</b>	\$3.25	\$2.75
<b>OAF2</b>	\$3.25	\$2.75
<b>OAF3</b>	\$3.25	\$2.75
<b>OAF4</b>	\$3.25	\$2.75

## SPINDLES I

- TURNED AND SANDED-READY TO STAIN
- BAGS OF 100 PIECES



**OGS**  
OAK  
1 1/2" L, 9/16" DIA, 1/4" TENON DIA

**MGS**  
MAPLE  
1 1/2" L, 9/16" DIA, 1/4" TENON DIA

**CGS**  
CHERRY  
1 1/2" L, 9/16" DIA, 1/4" TENON DIA



**ORS**  
OAK  
2 1/8" L, 3/8" TENON DIA

**MRS**  
MAPLE  
2 1/8" L, 3/8" TENON DIA

**CRS**  
CHERRY  
2 1/8" L, 3/8" TENON DIA

ITEM	1+	100+	500+	1000+
<b>OGS</b>	\$0.22	\$0.19	\$0.15	\$0.12
<b>MGS</b>	\$0.25	\$0.20	\$0.17	\$0.13
<b>CGS</b>	\$0.25	\$0.20	\$0.17	\$0.13
<b>ORS</b>	\$0.38	\$0.30	\$0.26	\$0.20
<b>MRS</b>	\$0.42	\$0.38	\$0.30	\$0.25
<b>CRS</b>	\$0.42	\$0.38	\$0.30	\$0.25

## SPINDLES II



**OA11-O**  
OAK  
11 1/4" L, 7/8" DIA, 3/8" TENON

**OA11-M**  
MAPLE  
11 1/4" L, 7/8" DIA, 3/8" TENON

**OA11-C**  
CHERRY  
11 1/4" L, 7/8" DIA, 3/8" TENON

ITEM	1+	50+	100+
<b>OA11-O</b>	\$1.68	\$1.37	\$1.16
<b>OA11-M</b>	\$1.68	\$1.37	\$1.16
<b>OA11-C</b>	\$1.89	\$1.58	\$1.37



**OA3-O**  
OAK  
3 1/2" L, 1/4" TENON

**OA3-M**  
MAPLE  
3 1/2" L, 1/4" TENON

**OA3-C**  
CHERRY  
3 1/2" L, 1/4" TENON



**OA6-O**  
OAK  
6" L, 1/4" TENON

**OA6-M**  
MAPLE  
6" L, 1/4" TENON

**OA6-C**  
CHERRY  
6" L, 1/4" TENON

ITEM	1+	100+	500+	1,000+
<b>OA3-O</b>	\$0.35	\$0.28	\$0.23	-
<b>OA3-M</b>	\$0.35	\$0.28	\$0.23	-
<b>OA3-C</b>	\$0.44	\$0.38	\$0.32	-
<b>OA6-O</b>	\$0.49	\$0.39	\$0.33	\$0.30
<b>OA6-M</b>	\$0.49	\$0.39	\$0.33	\$0.30
<b>OA6-C</b>	\$0.70	\$0.60	\$0.49	\$0.43
<b>OA9-O</b>	\$1.10	\$0.85	\$0.75	\$0.69
<b>OA9-M</b>	\$1.10	\$0.85	\$0.75	\$0.69
<b>OA9-C</b>	\$1.35	\$1.10	\$0.95	\$0.89
<b>OA10-O</b>	\$1.25	\$0.95	\$0.85	\$0.79
<b>OA10-M</b>	\$1.25	\$0.95	\$0.85	\$0.79
<b>OA10-C</b>	\$1.40	\$1.10	\$0.99	\$0.95



**OA9-O**  
OAK  
9" L, 3/8" TENON

**OA9-M**  
MAPLE  
9" L, 3/8" TENON

**OA9-C**  
CHERRY  
9" L, 3/8" TENON



**OA10-O**  
OAK  
9" L, 3/8" TENON

**OA10-M**  
MAPLE  
9" L, 3/8" TENON

**OA10-C**  
CHERRY  
9" L, 3/8" TENON

- HEAVY SPINDLE
- HEAVY SPINDLE
- HEAVY SPINDLE



## JOINTING BISCUITS



ITEM	PER 100	PER 500	PER 1,000
<b>JB0</b>	\$4.40	\$18.70	\$26.40
<b>JB10</b>	\$4.40	\$20.90	\$28.60
<b>JB20</b>	\$4.40	\$20.90	\$30.80

## PEGS



### CLASSIC SHAKER PEG

**OSP1**  
OAK  
**OSP2**  
CHERRY  
**OSP3**  
WALNUT  
3 1/2" L, 1/2" TENONS



### ECONOMY SHAKER PEG

**OSP4**  
OAK  
**OSP5**  
BIRCH  
3 1/2" L, 1/2" TENONS



### MINI SHAKER PEG

**OSP6**  
OAK  
**OSP7**  
BIRCH  
1 3/4" L, 1/4" TENON



### OAK SHORTY PEG

**OSP87**  
OAK  
**OSP88**  
BIRCH  
2 1/2" L

ITEM	1+	100+	500+
<b>OSP1</b>	\$0.58	\$0.47	\$0.37
<b>OSP2</b>	\$0.68	\$0.58	\$0.45
<b>OSP3</b>	\$0.68	\$0.58	\$0.45
<b>OSP4</b>	\$0.47	\$0.42	\$0.37
<b>OSP5</b>	\$0.37	\$0.26	\$0.20
<b>OSP6</b>	\$0.25	\$0.18	\$0.15
<b>OSP7</b>	\$0.19	\$0.16	\$0.13
<b>OSP87</b>	\$0.37	\$0.30	\$0.21
<b>OSP88</b>	\$0.28	\$0.18	\$0.15

## PLUGS

### FACE GRAIN PLUGS

**FGP-O**  
OAK  
**FGP-M**  
MAPLE  
**FGP-C**  
CHERRY  
**FGP-W**  
WALNUT  
1/4" THICK



ITEM	3/8" DIAMETER		1/2" DIAMETER		3/4" DIAMETER		1" DIAMETER	
	500PC	1000PC	500PC	1000PC	500PC	1000PC	500PC	1000PC
<b>FGP-O</b>	\$34.00	\$62.00	\$38.00	\$64.00	\$44.00	\$82.00	\$64.00	\$115.00
<b>FGP-M</b>	\$34.00	\$62.00	\$38.00	\$64.00	\$44.00	\$82.00	\$64.00	\$115.00
<b>FGP-C</b>	\$38.00	\$64.00	\$39.00	\$74.00	\$92.00	\$184.00	\$67.00	\$120.00
<b>FGP-W</b>	\$38.00	\$64.00	\$39.00	\$74.00	\$69.00	\$129.00		

PLEASE SPECIFY DIAMETER SIZE

### STANDARD BUTTONS

**MB3/8-O**  
OAK  
**MB3/8-M**  
MAPLE  
**MB3/8-C**  
CHERRY  
**MB1/2-O**  
OAK  
**MB1/2-M**  
MAPLE  
**MB3/8-W**  
WALNUT



ITEM	1000+	5000+
<b>MB3/8-O</b>	\$29.95	\$27.95
<b>MB3/8-M</b>	\$19.00	\$16.50
<b>MB3/8-C</b>	\$35.00	\$32.00
<b>MB3/8-W</b>	\$34.00	\$28.00
<b>MB1/2-O</b>	\$34.00	\$32.00
<b>MB1/2-M</b>	\$21.00	\$19.00

PRICES LISTED ABOVE ARE PRICED PER 1000

### FLAT PLUG

**FP1/2-O**  
OAK  
**FP1/2-C**  
CHERRY  
**FP3/8-O**  
OAK  
**FP3/8-M**  
MAPLE  
**FP3/8-C**  
CHERRY  
**FP3/8-H**  
HICKORY



ITEM	1000+	5000+
<b>FP3/8-O</b>	\$23.95	\$22.50
<b>FP3/8-M</b>	\$18.50	\$16.95
<b>FP3/8-C</b>	\$44.00	\$42.00
<b>FP3/8-H</b>	\$32.00	\$28.50
<b>FP1/2-O</b>	\$28.00	\$26.00
<b>FP1/2-C</b>	\$45.00	\$43.00

PRICES LISTED ABOVE ARE PRICED PER 1000

### HMB-3/8-O

OAK  
3/8" DIA  
■ HIGH GRADE  
■ LONGER SHANK



ITEM	1000+	3000+
<b>HMB3/8-O</b>	\$32.00	\$29.00

PRICES LISTED ABOVE ARE PRICED PER 1000

### OVAL PLUG

**OP3/8-O**  
OAK  
**OP3/8-M**  
MAPLE  
**OP3/8-C**  
CHERRY



ITEM	1000+	5000+
<b>OP3/8-O</b>	\$20.00	\$18.00
<b>OP3/8-M</b>	\$17.95	\$14.95
<b>OP3/8-C</b>	\$43.00	\$40.00

PRICES LISTED ABOVE ARE PRICED PER 1000

**BRACKET FEET**

- READY TO INSTALL
- PLYWOOD TOP WITH GLUED AND V-NAILED CORNERS FOR EASY INSTALLATION
- OTHER STYLES AND SPECIES AVAILABLE FOR SPECIAL ORDER (MIN 10 SETS)
- SOLD IN SETS OF 2 FRONT & 2 BACK

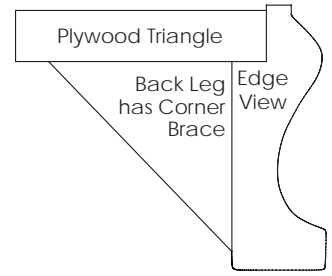

**TRADITIONAL STYLE- 6"**

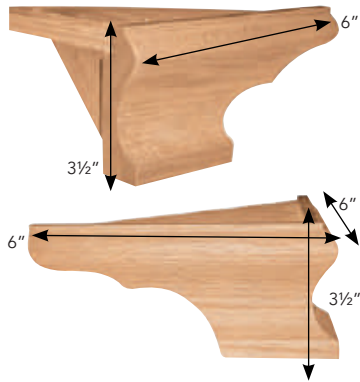

- WC6** RED OAK
- WC6-C** CHERRY
- WC6-Q** QSWO
- WC6-M** MAPLE
- WC6-H** HICKORY
- WC6-A** ASH
- WC6-E** GREY ELM

ITEM	SOLD IN	1+	10+	20+
<b>WC6</b>	SETS	\$24.56	\$23.58	\$23.19
<b>WC6-C</b>	SETS	\$26.41	\$25.36	\$24.93
<b>WC6-Q</b>	SETS	\$36.25	\$34.80	\$34.22
<b>WC6-M</b>	SETS	\$26.84	\$25.76	\$25.33
<b>WC6-H</b>	SETS	\$27.44	\$26.36	\$25.92
<b>WC6-A</b>	SETS	\$26.00	\$23.94	\$22.75
<b>WC6-E</b>	SETS	\$32.99	\$31.67	\$31.14

**TRADITIONAL STYLE- 7"**

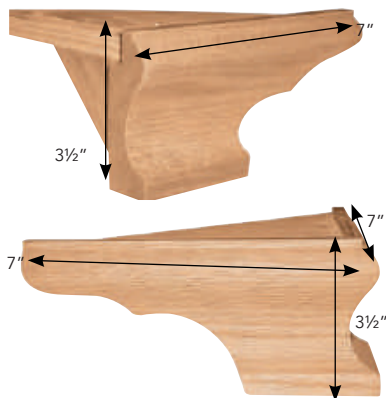

- WC7** RED OAK
- WC7-C** CHERRY
- WC7-Q** QSWO
- WC7-M** MAPLE
- WC7-H** HICKORY
- WC7-A** ASH
- WC7-E** GREY ELM

ITEM	SOLD IN	1+	10+	20+
<b>WC7</b>	SETS	\$26.06	\$25.02	\$24.60
<b>WC7-C</b>	SETS	\$28.19	\$27.06	\$26.61
<b>WC7-Q</b>	SETS	\$39.40	\$37.82	\$37.19
<b>WC7-M</b>	SETS	\$28.70	\$27.55	\$27.09
<b>WC7-H</b>	SETS	\$29.29	\$28.12	\$27.65
<b>WC7-A</b>	SETS	\$28.30	\$25.50	\$24.25
<b>WC7-E</b>	SETS	\$35.60	\$34.18	\$33.61

**TRADITIONAL STYLE- 8"**

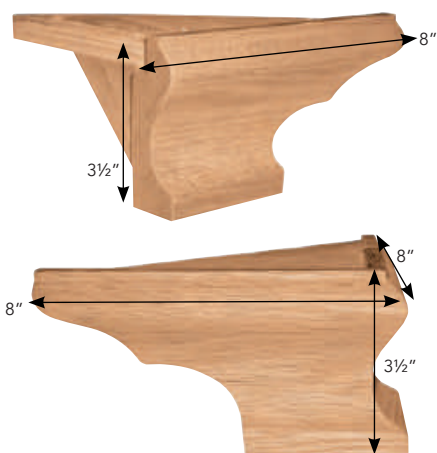

- WC8** RED OAK
- WC8-C** CHERRY
- WC8-Q** QSWO
- WC8-M** MAPLE
- WC8-H** HICKORY
- WC8-A** ASH
- WC8-E** GREY ELM

ITEM	SOLD IN	1+	10+	20+
<b>WC8</b>	SETS	\$27.78	\$26.66	\$26.22
<b>WC8-C</b>	SETS	\$30.09	\$28.88	\$28.40
<b>WC8-Q</b>	SETS	\$43.14	\$40.96	\$40.27
<b>WC8-M</b>	SETS	\$30.64	\$29.41	\$28.92
<b>WC8-H</b>	SETS	\$31.21	\$29.96	\$29.46
<b>WC8-A</b>	SETS	\$30.00	\$27.05	\$25.69
<b>WC8-E</b>	SETS	\$38.31	\$36.78	\$36.17

## TRADITIONAL CENTERS



**WC10**  
RED OAK  
10 1/2" CENTER  
**WC10-C**  
CHERRY  
10 1/2" CENTER  
**WC10-Q**  
QSWO  
10 1/2" CENTER  
**WC10-M**  
MAPLE  
10 1/2" CENTER  
**WC10-H**  
HICKORY  
10 1/2" CENTER  
**WC10-A**  
ASH  
10 1/2" CENTER  
**WC10-E**  
GREY ELM  
10 1/2" CENTER

**WC16**  
RED OAK  
16" CENTER  
**WC16-C**  
CHERRY  
16" CENTER  
**WC16-Q**  
QSWO  
16" CENTER  
**WC16-M**  
MAPLE  
16" CENTER  
**WC16-H**  
HICKORY  
16" CENTER  
**WC16-A**  
ASH  
16" CENTER  
**WC16-E**  
GREY ELM  
16" CENTER

ITEM	1+	10+
<b>WC10</b>	\$8.69	\$7.76
<b>WC10-C</b>	\$9.24	\$8.25
<b>WC10-Q</b>	\$12.45	\$11.11
<b>WC10-M</b>	\$9.38	\$8.38
<b>WC10-H</b>	\$9.65	\$8.61
<b>WC10-A</b>	\$8.32	\$7.43
<b>WC10-E</b>	\$11.69	\$10.44
<b>WC16</b>	\$10.29	\$9.19
<b>WC16-C</b>	\$11.19	\$9.99
<b>WC16-Q</b>	\$16.17	\$14.44
<b>WC16-M</b>	\$11.41	\$10.19
<b>WC16-H</b>	\$11.41	\$10.41
<b>WC16-A</b>	\$9.76	\$8.71
<b>WC16-E</b>	\$14.57	\$13.01

## MISSION STYLE

■ SOLD IN SETS 2 FRONT & 2 BACK CORNERS

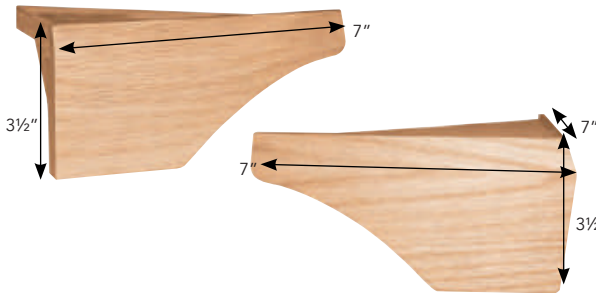

**WCM7**  
RED OAK  
**WCM7-C**  
CHERRY  
**WCM7-Q**  
QSWO  
**WCM7-M**  
MAPLE  
**WCM7-H**  
HICKORY  
**WCM7-A**  
ASH  
**WCM7-E**  
GREY ELM

ITEM	SOLD IN	1+	10+	20+
<b>WCM7</b>	SETS	\$26.09	\$25.04	\$24.63
<b>WCM7-C</b>	SETS	\$28.19	\$27.06	\$26.61
<b>WCM7-Q</b>	SETS	\$37.54	\$36.04	\$35.44
<b>WCM7-M</b>	SETS	\$28.14	\$27.01	\$26.56
<b>WCM7-H</b>	SETS	\$28.31	\$27.25	\$26.80
<b>WCM7-A</b>	SETS	\$28.34	\$25.50	\$25.08
<b>WCM7-E</b>	SETS	\$29.10	\$27.94	\$27.47

## COLONIAL STYLE



**WC9-10**  
RED OAK  
**WC9-10C**  
CHERRY  
**WC9-10Q**  
QSWO  
**WC9-10M**  
MAPLE  
**WC9-10H**  
HICKORY  
**WC9-10A**  
ASH  
**WC9-10E**  
GREY ELM

ITEM	SOLD IN	1+	10+	20+
<b>WC9-10</b>	SETS	\$28.20	\$27.07	\$26.62
<b>WC9-10C</b>	SETS	\$34.35	\$31.10	\$29.64
<b>WC9-10Q</b>	SETS	\$42.55	\$40.85	\$40.17
<b>WC9-10M</b>	SETS	\$31.64	\$30.37	\$29.87
<b>WC9-10H</b>	SETS	\$31.06	\$29.82	\$29.32
<b>WC9-10A</b>	SETS	\$27.98	\$26.86	\$26.41
<b>WC9-10E</b>	SETS	\$34.43	\$33.05	\$32.50

## TRADITIONAL STYLE CORNER CUPBOARD

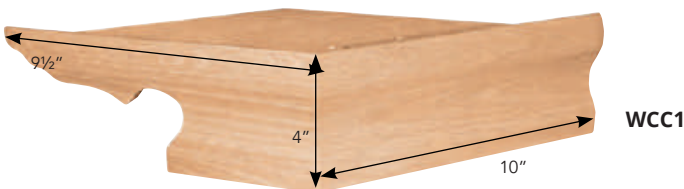

**WCC1**

ITEM	WOOD	SOLD IN	1+	10+
<b>WCC1</b>	RED OAK	SETS	\$33.83	\$32.47
<b>WCC1-C</b>	CHERRY	SETS	\$36.65	\$35.18
<b>WCC1-Q</b>	QSWO	SETS	\$42.65	\$40.97
<b>WCC1-M</b>	MAPLE	SETS	\$35.64	\$34.21
<b>WCC1-H</b>	HICKORY	SETS	\$36.21	\$34.76

TABLE LEGS

QUEEN ANNE TABLE LEGS

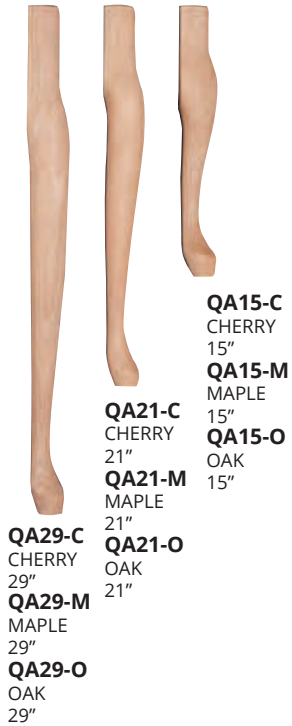

COUNTRY TABLE LEGS

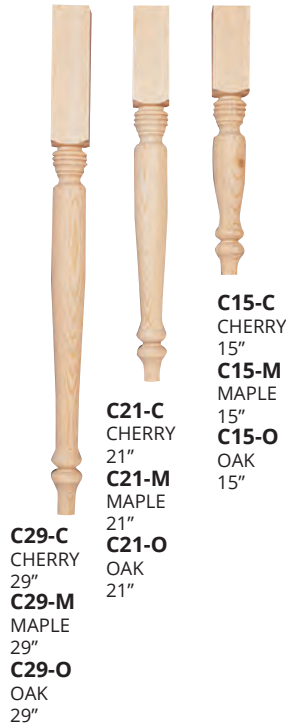

COUNTRY FRENCH TABLE LEGS

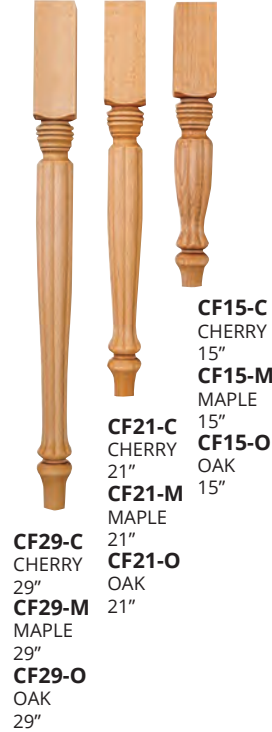

ITEM	STYLE	EACH
QA15-C	QUEEN ANNE	\$15.85
QA21-C	QUEEN ANNE	\$18.95
QA29-C	QUEEN ANNE	\$22.91
QA15-M	QUEEN ANNE	\$12.50
QA21-M	QUEEN ANNE	\$14.50
QA29-M	QUEEN ANNE	\$16.25
QA15-O	QUEEN ANNE	\$13.75
QA21-O	QUEEN ANNE	\$17.95
QA29-O	QUEEN ANNE	\$19.75
C15-C	COUNTRY	\$12.50
C21-C	COUNTRY	\$13.25
C29-C	COUNTRY	\$21.50
C15-M	COUNTRY	\$9.95
C21-M	COUNTRY	\$13.50
C29-M	COUNTRY	\$20.50
C15-O	COUNTRY	\$14.50
C21-O	COUNTRY	\$16.25
C29-O	COUNTRY	\$25.50
CF15-C	COUNTRY FRENCH	\$12.95
CF21-C	COUNTRY FRENCH	\$15.75
CF29-C	COUNTRY FRENCH	\$23.50
CF15-M	COUNTRY FRENCH	\$11.50
CF21-M	COUNTRY FRENCH	\$14.95
CF29-M	COUNTRY FRENCH	\$22.50
CF15-O	COUNTRY FRENCH	\$14.95
CF21-O	COUNTRY FRENCH	\$17.00
CF29-O	COUNTRY FRENCH	\$27.50

TABLE LEG MEASUREMENTS

STYLE	SQ. SIZE (SS)	TURNED LENGTH (TL)	OVERALL LENGTH (OL)
QUEEN ANNE	2 1/8"	9 1/2"	15"
QUEEN ANNE	2 1/8"	16"	21"
QUEEN ANNE	2 1/8"	21 1/2"	29"
COUNTRY	2 1/4"	10"	15 1/4"
COUNTRY	2 1/4"	15 1/2"	21 1/4"
COUNTRY	2 1/4"	21"	29"
COUNTRY FRENCH	2 1/4"	10 1/2"	15 1/4"
COUNTRY FRENCH	2 1/4"	16"	21 1/4"
COUNTRY FRENCH	2 1/4"	21"	29"

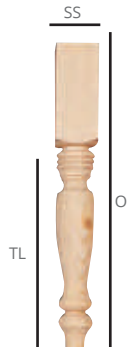

BUN FEET

■ MOST BUN FEET INCLUDE A PRE-INSTALLED HANGER BOLT



ITEM	WOOD	SIZE	EACH
BF42-P	PINE	4"W X 2"H	\$3.50
BF42-O	OAK	4"W X 2"H	\$6.50
BF42-M	MAPLE	4"W X 2"H	\$6.50
BF42-C	CHERRY	4"W X 2"H	\$6.50
BF52-A	ASH	5"W X 2 1/4"H	\$11.00
BF52-O	OAK	5"W X 2 1/4"H	\$8.50
BF52-M	MAPLE	5"W X 2 1/4"H	\$8.50
BF52-C	CHERRY	5"W X 2 1/4"H	\$8.50
BF100-C	CHERRY	3"W X 3 1/2"H	\$8.50
BF100-M	BR MAPLE	3"W X 3 1/2"H	\$6.50
BF100-O	OAK	3"W X 3 1/2"H	\$6.50
BF44-O	OAK	3 1/4"W X 4 3/4"H	\$8.00
BF44-M	MAPLE	3 1/4"W X 4 3/4"H	\$8.00
BF44-C	CHERRY	3 1/4"W X 4 3/4"H	\$8.00

## KREG JIG

- REMOVABLE DRILL GUIDE FOR BENCH TOP AND MOBILE USE
- HARDENED STEEL CORE 3 DRILL GUIDE W/ FIXED SPACING
- 1/8" INCREMENT SETTINGS FOR MATERIALS FROM 1/2" TO 1 1/2" THICK
- LARGE CLAMPING RECESS
- STURDY TOGGLE-CLAMP
- GLASS REINFORCED NYLON BODY

ITEM	PRICE
<b>K4</b>	\$99.00



**K4**  
KIT INCLUDES:

- KREG JIG W/ 6" SQUARE DRIVER AND STEPPED DRILL BIT
- STARTER SCREW AND STARTER PLUG SET
- SKILLBUILDER DVD
- QUICK-START GUIDE
- COMPACT DURABLE CARRYING CASE

## KREG FOREMAN

### POCKET HOLE MACHINE DB210 ELECTRIC

ITEM	PRICE
<b>DB210</b>	\$449.00

- SINGLE-STEP OPERATION STARTS MOTOR, CLAMPS WORKPIECE AND DRILLS POCKET HOLES
- CREATES ALL KREG JOINT SIZES STANDARD, MICRO AND HD
- WORKS WITH MATERIAL FROM 1/2" TO 1 1/2" THICK
- ADJUSTABLE STOPS FOR REPEATABLE ACCURACY
- POWERFUL 110-V, 5.0-AMP, 2,800 RPM MOTOR PROVIDES FAST DRILLING



## KREG JIG DRILL BIT & ACCESSORIES



### DKDB-BIT

- MACHINE BIT IS MADE OF COBALT STEEL
- HAS A 3/8" DIAMETER AND CAN BE USED IN ANY OF OUR OTHER MANUAL JIGS



### QUIK-BIT

- WORKS WITH STANDARD AND QUICK CHANGE CHUCKS
- ONE-PIECE RUGGED DESIGN FROM HIGH SPEED STEEL

ITEM	DESCRIPTION	1+	5+
<b>DKDB-BIT</b>	FOR DK1100, DK3100 AND DB210	\$32.00	\$28.00
<b>KJSC/D</b>	ALLEN WRENCH AND DEPTH COLLAR	\$2.50	\$2.25
<b>LH-DKDB</b>	FOR DK3100 CENTER SPINDLE (LEFT HAND)	\$29.50	\$28.00
<b>QUIK-BIT</b>	FOR ALL MANUAL KREG JIGS AND DB210	\$15.95	\$14.50



**ALLEN WRENCH AND DEPTH COLLAR  
KJSC/D**

## TFE LUBE



- FLUOROTELOMER LUBRICANT & RELEASE AGENT
- DRIP LESS AEROSOL
- LONG LASTING NON-GREASY DRY FILM
- PRESERVES AND LENGTHENS SERVICE LIFE OF MACHINERY PARTS
- RESISTS MOISTURE, RUST, AND CORROSION
- NON STAINING COLORLESS
- PINPOINT APPLICATION
- LUBRICATES HARD TO REACH PLACES
- LESSENS CHANCE OF STRAIN OR BREAKAGE
- PENETRATES CLOSE TOLERANCES OF MOVING PARTS

ITEM	1+	12+
<b>TFE-LUBE</b>	\$19.95	\$17.95



## KREG CONCEALING POCKET HOLES

- SOLID KREG WOOD PLUGS IN A VARIETY OF WOOD SPECIES
- GLUE IN AND SAND FLUSH TO CONCEAL POCKET HOLES
- PLASTIC CAPS ARE ALSO AVAILABLE FOR LAMINATED SURFACES



ITEM	100+	1000+
<b>KPL-M</b>	\$18.00/C	\$157.50/M
<b>KPL-O</b>	\$18.00/C	\$157.50/M

**KPL-M**  
MAPLE  
**KPL-O**  
OAK

## CLEANERS, LUBE AND DEBONDER



### POLISH & CLEANER MPC1 LEMON SCENT MPC2 ORANGE SCENT

ITEM	1+	Case of 12
<b>MPC1</b>	\$6.95	\$5.75/PC
<b>MPC2</b>	\$6.95	\$5.75/PC

- PRESERVES & PROTECTS FINISHES
- NO WAX OR SILICONES
- COVERS FINE SCRATCH MARKS
- 12 OZ BOTTLE
- REMOVES WATER RINGS, SOAP SCUM, AND ADHESIVES
- PROTECTS AGAINST DAMPNESS AND DRYNESS



## KREG CLAMPS

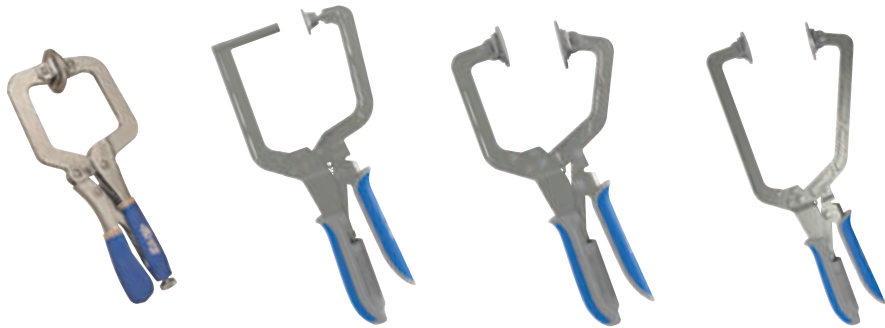

**PREMIUM FACE CLAMP**  
KHC-PREMIUM  
3 1/4" REACH

**RIGHT ANGLE CLAMP WITH AUTOMAXX**  
KHCRA

**3" FACE CLAMP WITH AUTOMAXX**  
KHC-3  
3" REACH

**6" FACE CLAMP WITH AUTOMAXX**  
KHC-6  
6" REACH

ITEM	MAX OPENING	PRICE
KHC-PREMIUM	2 3/4"	\$20.00
KHCRA	-	\$32.00
KHC-3	3"	\$26.50
KHC-6	5"	\$33.50



## WOOD FILLER

### BLACK INSTANT GLUE - *NEW!*



ITEM	1+	6+	12+
M745-1330	\$12.25	\$11.75	\$10.95

**BLACK INSTANT GLUE**

USED TO EFFECTIVELY FILL JOINTS FOR A SEAMLESS APPEARANCE PRIOR TO PAINTING. IT SERVES AS A QUICK SETTING, STABILIZING, PRODUCTION JOINT FILLER.



### FIL-O-WOOD PUTTY TUBE - *NEW!*

ITEM	COLOR	1+	6+	12+
M742-2000	CLEAR	\$6.85	\$6.40	\$5.95
M742-2002	NATURAL OAK	\$6.85	\$6.40	\$5.95
M742-2005	DARK WALNUT	\$6.85	\$6.40	\$5.95
M742-2006	COLONIAL MAPLE	\$6.85	\$6.40	\$5.95
M742-2007	DARK MAPLE	\$6.85	\$6.40	\$5.95
M742-2008	RED MAHOGANY	\$6.85	\$6.40	\$5.95
M742-2009	AMBER NATURAL	\$6.85	\$6.40	\$5.95
M742-2011	CHERRY	\$6.85	\$6.40	\$5.95
M742-2012	GOLDEN OAK	\$6.85	\$6.40	\$5.95
M742-2020	FRUITWOOD	\$6.85	\$6.40	\$5.95



**FIL-O-WOOD PUTTY TUBE**

EXPANDED COLOR RANGE STAYS SOFT & PLIABLE LONGER IN THE PACKAGE DRIES MORE QUICKLY SAME SANDABILITY GREAT FOR PRODUCTION WORK, AND ALL WOOD REPAIRS



### EPOXY ADHESIVE - *NEW!*

ITEM		1+	25+
M745-1431	ADHESIVE	\$12.95	\$11.75
M745-1433	DISPENSING GUN	\$49.95	—
M745-1435	TIPS	\$17.50/12PK	—



**EPOXY ADHESIVE**

TWO-PART INDUSTRIAL GRADE ADHESIVE WHICH MIXES IN THE DISPENSING UNIT TIP. NO MESS, NO MEASURING. SETS IN 6 TO 8 MINUTES. CLEAR AND WOODTONE AVAILABLE. WOOD TONE CAN ALSO BE USED AS A FILLER. NOTE: MIXING TIPS ARE NOT INCLUDED WITH ADHESIVE OR GUN AND MUST BE PURCHASED SEPARATELY.



### GLAZE COAT EPOXY - *NEW!*

#### FAMOWOOD



**FM-110**  
1 GALLON KIT

**GLAZE COAT EPOXY**

THIS ULTRA-CLEAR, HIGH GLOSS FINISHING EPOXY IS IDEAL FOR HOME IMPROVEMENT AND CRAFT PROJECTS. FAMOWOOD GLAZE COAT IS A POUR-ON EPOXY COATING THAT CAN BE USED ON MOST SURFACES - ROUGH OR SMOOTH, STAINED OR PAINTED. IT'S GREAT FOR COATING TABLES OR BAR TOPS, PRESERVING PHOTOGRAPHS OR IMBEDDING DECORATIVE ITEMS. JUST ONE COAT EQUALS 70 COATS OF VARNISH!

- EASY 1:1 MIXING RATIO
- VERSATILE - USE ON ANY NON WAXY MATERIAL
- SELF-LEVELING - MINIMAL SPREADING REQUIRED
- INDOOR USE
- RESISTS TEMPERATURES UP TO 120 °F

ITEM	1+	4+
FM-110	\$62.50	\$57.95

## KNOT FILLER REPAIR KIT - *NEW!*



M319-6000

### KNOT FILLER REPAIR KIT

INTRODUCING THE KNOT FILLER REPAIR KIT! THE KNOT FILLER REPAIR KIT IS EASY TO USE, AND THE RESULT IS GREAT WHETHER YOU ARE FIXING A SPLIT, OTHER DAMAGE OR LOOSE AND MISSING KNOTS. KNOT FILLER IS SUITABLE FOR ALL SORTS OF WOODEN SURFACES SUCH AS FLOORING, FURNITURE, WINDOWS ETC.

- MADE OF 99% POLYAMIDE
- FAST, EASY APPLICATION
- HARDENS WITHIN SECONDS
- UV RESISTANT
- DOES NOT SINK OR SHRINK
- INDOOR / OUTDOOR USE
- NON-TOXIC
- ADHERES AND WILL NOT FALL OUT STABILIZING AND MAKING THE KNOT STRONGER
- LASTS UP TO 5 TIMES LONGER IN THE WOOD

ITEM	1+
M319-6000	\$349.95

### KNOT FILLER STICKS

ITEM	COLOR	PACK OF 9
M319-6005	CLEAR	\$74.95
M319-6007	GREY	\$74.95
M319-6008	WHITE	\$108.50
M319-6009	ASH	\$74.95
M319-6010	PINE	\$74.95
M319-6011	OAK	\$74.95
M319-6012	BEECH	\$74.95
M319-6013	WALNUT	\$74.95
M319-6014	MAHOGANY	\$74.95
M319-6016	PINE LIGHT	\$74.95
M319-6017	CHERRY	\$74.95
M319-6006	BLACK	\$74.95

## EPOXY PUTTY STICKS - *NEW!*



### EPOXY PUTTY STICK

RESTORE, REBUILD AND REPAIR ALL KINDS OF WOOD AND OTHER HARD SURFACES. QUICKLY CURES TO A DURABLE, PERMANENT STATE TO ALLOW SANDING, DRILLING, STAINING AND GENERAL FINISHING AFTER JUST 20 MINUTES (8-10 MINUTES WORKING TIME, DEPENDING ON COLOR.) EXCELLENT ADHESION OF WOOD TO METAL, GLASS AND EVEN CERAMIC SURFACES.

- EASY TO USE AND VERSATILE
- MATCHES COLOR OF WOOD SURFACES
- MAKES PERMANENT REPAIRS
- 8-10 MINUTE WORKABLE TIME DEPENDING ON COLOR
- FAST CURING WITHIN 20 MINUTES
- NO SHRINKAGE AND MOLDS TO ANY SHAPE

ITEM	COLOR	1+	12+	24+
M743-1500	BEIGE	\$10.95	\$9.25	\$8.49
M743-1510	PINE	\$10.95	\$9.25	\$8.49
M743-1520	WHITE	\$10.95	\$9.25	\$8.49
M743-1530	OAK / LIGHT WALNUT	\$10.95	\$9.25	\$8.49
M743-1540	MAHOGANY	\$10.95	\$9.25	\$8.49
M743-1550	CHERRY	\$10.95	\$9.25	\$8.49
M743-1560	WALNUT	\$10.95	\$9.25	\$8.49
M743-1570	BLACK	\$10.95	\$9.25	\$8.49
M743-1575	NATURAL OAK	\$10.95	\$9.25	\$8.49
M743-1580	NATURAL MAPLE	\$10.95	\$9.25	\$8.49
M743-1585	NATURAL CHERRY	\$10.95	\$9.25	\$8.49
M743-1590	RAW UMBER	\$10.95	\$9.25	\$8.49

## FAMOWOOD FILLER



FM65  
PINT



FM64  
1/4 PINT

### SOLVENT-BASED WOOD FILLER

SPECIES AVAILABLE:  
ASH, BIRCH, CHERRY, FIR, MAPLE,  
NATURAL/TUPELO, OAK/TEAK, RED  
OAK, WALNUT, PINE

- NO NOTICEABLE SHRINKAGE
- SANDS EASILY
- DRIES QUICKLY
- INTERIOR/EXTERIOR



FM69  
PINT



FM68  
1/4 PINT

### PLEASE SPECIFY WOOD SPECIES WHEN ORDERING

ITEM	SIZE	1+	6+	CASE OF 12
FM64	1/4 PINT	\$3.50	\$3.25	\$2.95
FM65	PINT	\$6.95	\$6.50	\$5.95
FM68	1/4 PINT	\$3.40	\$3.10	\$2.85
FM69	PINT	\$6.90	\$6.35	\$5.90

### WATER-BASED WOOD FILLER

SPECIES AVAILABLE:  
CHERRY, OAK, WALNUT, RED OAK,  
NATURAL, BIRCH

- NO NOTICEABLE SHRINKAGE
- SANDS EASILY
- DRIES QUICKLY
- FREE FROM SOLVENT FUMES
- CLEANS UP WITH WATER

330-897-0017



Fax Order 330-897-0022

## ZAP ADHESIVES



**GREEN ZAP-A-GAP CA+ - GAP FILLING FORMULA**  
**PT01 - 2 OZ**  
**PT02 - 1 OZ**  
**PT05 - 4 OZ**

- THICKER VERSION OF ZAP/CA
- BONDS ALMOST ANYTHING IN 5 - 10 SECONDS
- WILL BRIDGE SLIGHT GAPS
- MOST VERSATILE FORMULA
- USE WITH BALSAM, PLYWOOD, SPRUCE AND HARDWOODS
- ALSO BONDS RUBBER, CHINA AND LEATHER
- WORKS THROUGH OILY SURFACES
- EXCELLENT FOR FURNITURE REPAIR
- FILLS LARGER GAPS WHEN USED WITH ZIP-KICKER ACCELERATOR
- GREAT FOR CARBON-FIBER OR FIBERGLASS PARTS
- 12 MONTH SHELF LIFE

ITEM	SIZE	SOLD IN	1+	PER 6	CASE OF 12	3 CASES
<b>PT01</b>	2 OZ	PIECES	\$9.50	\$7.95	-	\$7.50
<b>PT02</b>	1 OZ	PIECES	\$5.50	-	\$4.35	-
<b>PT05</b>	4 OZ	PIECES	\$15.95	\$13.50	-	\$12.95
<b>PT06</b>	4 OZ	PIECES	\$15.95	\$13.50	-	\$12.95
<b>PT07</b>	2 OZ	PIECES	\$9.50	\$7.95	-	\$7.50
<b>PT08</b>	1 OZ	PIECES	\$5.50	-	\$4.35	-
<b>PT16</b>	1 OZ	PIECES	\$3.75	-	\$2.75	-
<b>PT27</b>	TUBE	PIECES	\$3.75	\$3.00	-	-
<b>PT33</b>	2 OZ	PIECES	\$9.50	\$7.95	-	-
<b>PT38</b>	BOX	PIECES	\$12.95	\$10.95	-	-
<b>PT39</b>	BOX	PIECES	\$12.95	\$10.95	-	-



**PINK ZAP/CA**  
**PT06 - 4 OZ**  
**PT07 - 2 OZ**  
**PT08 - 1 OZ**

- SUPER-THIN PENETRATING FORMULA
- INSTANT CURING
- MICRO DROPPER INCLUDED IN CAP
- TWO DROPS BONDS CLOSE-FITTING PARTS
- WICKING ACTION PRODUCES A PERMANENT BOND IN SECONDS
- GREAT FOR "TACKING" APPLICATIONS
- ADDS STRENGTH TO FIBERGLASS OR CLOTH
- ESPECIALLY GOOD FOR BALSAM WOOD
- BONDS IN 1 TO 5 SECONDS
- 12 MONTH SHELF LIFE



**ZAP GEL**  
**PT27**

- IDEAL FOR VERTICAL SURFACES
- WILL NOT RUN
- ONE DROP IS ALL IT TAKES
- BONDS IN 15 SECONDS
- CURES IN 15 MINUTES
- VERY CONCENTRATED CA LIKE THICK JELLY W/ THE SAME FORMULATION AS ZAP-A-GAP



**30-MINUTE Z-POXY**  
**PT39**

- 15 MIN WORKING TIME
- CURES IN 30 MINUTES
- EQUAL MIX
- CLEAR FORMULA
- FOR WOODS, FIBERGLASS, COMPOSITES, AND SOME METALS
- WILL WORK WELL WITH FILLERS LIKE MICRO BALLOONS



**SLO ZAP CA**  
**PT33**

- SUPER THICK FORMULA
- 30-40 SECONDS FOR POSITIONING
- UP TO 90 SECONDS CURE TIME
- SUPER ON LARGE SURFACE AREAS OR TOUGH-TO-GET-AT JOINTS
- IDEAL FOR FILLET FORMING OR LAMINATING
- VERY STRONG FORMULA FOR HIGH STRESS AREAS
- EXCELLENT FOR HOUSEHOLD REPAIRS
- MAKES PLANKING OPERATION OF BOATS & AIRPLANES A BREEZE
- 12 MONTH SHELF LIFE



**5-MINUTE Z-POXY**  
**PT38**

- CLEAR
- EQUAL MIX
- 3-MINUTE POT LIFE
- SOLVENT AND VIBRATION-RESISTANT FORMULA
- CURES IN 5 MINUTES
- FLEXIBLE
- DURABLE
- SANDABLE



**Z-7 ADHESIVE DEBONDER**  
**PT16**

- DEBONDING AGENT FOR SUPER GLUES
- SOFTENS CURED SUPER GLUES INTO A JELLY-LIKE SUBSTANCE THAT IS EASILY REMOVED FROM FINGERS & OTHER SURFACES
- DISSASSEMBLES CURED GLUE JOINTS IN 4 MINUTES
- STRONG FORMULA MAY SOFTEN SOME PLASTICS OR MAR SOME PAINTED SURFACES-ALWAYS TEST FIRST
- UNLIMITED SHELF LIFE

## ZAP ACCELERATOR



**KICKER AEROSOL**  
**PT-15**  
 2 OZ



**ZIP KICKER AEROSOL**  
**PT-50**  
 5 OZ



**ZIP KICKER REFILL**  
**PT-29**  
 8 OZ



**ZIP KICKER PUMP**  
**PT-715**  
 2 OZ

**EXTRA SPRAYER CAPS**  
**PT15-X**

ITEM	1+	6+	18+
<b>PT-15</b>	\$5.75	\$4.75	\$4.50
<b>PT15-X</b>	\$0.45	-	-
<b>PT-29</b>	\$8.95	\$7.95	\$7.50
<b>PT-50</b>	\$6.75	\$5.75	\$5.50
<b>PT-715</b>	\$5.75	\$4.75	\$4.50



## GLUBOT BOTTLES



**GLBOT-2**  
16 OZ  
**REPLACEMENT TIP**  
**GLTIP2**



**GLBOT-1**  
4 OZ  
**REPLACEMENT TIP**  
**GLTIP1**

ITEM	1+	6+
<b>GLBOT-1</b>	\$6.50	\$5.95
<b>GLBOT-2</b>	\$7.50	\$6.95
<b>GLTIP1</b>	\$1.00	-
<b>GLTIP2</b>	\$1.00	-

## TITEBOND ADHESIVE

DESCRIPTION	ITEM	1 GAL	2 GAL	6 GAL	ITEM	1 PAIL	4 PAILS	ITEM	1+
ORIGINAL	<b>TB-5066</b>	\$17.00	\$16.00	\$15.00	<b>TB-5067</b>	\$69.95	\$67.95	<b>TB-50609</b>	\$28.95
TITEBOND II	<b>TB-5006</b>	\$19.00	\$18.50	\$17.95	<b>TB-31197</b>	\$74.95	\$72.95	<b>PUMP</b>	\$9.95
TITEBOND III	<b>TB-1416</b>	\$25.50	\$25.00	\$23.95	<b>TB-5007</b>	\$86.00	\$84.00	<b>TB-50009</b>	\$32.95



### ORIGINAL TITEBOND

TITEBOND ORIGINAL CAN HELP ANY WOODWORKER ACHIEVE PROFESSIONAL-LOOKING RESULTS. IT IS IDEAL FOR WOOD, HARDBOARD, PARTICLE BOARD, LEATHER, CLOTH AND MOST OTHER POROUS MATERIALS. TITEBOND ORIGINAL IS EASY TO USE, NON-TOXIC AND CLEANS UP WITH WATER.



### PREMIUM TITEBOND II

TITEBOND II PREMIUM PROVIDES A STRONG INITIAL TACK, FAST SPEED OF SET, SUPERIOR STRENGTH AND EXCELLENT SANDABILITY. IT IS FDA APPROVED FOR INDIRECT FOOD CONTACT (CUTTING BOARDS) AND IS IDEAL FOR RADIO FREQUENCY (R-F) GLUING SYSTEMS.



**ORIGINAL TITEBOND**  
**TB-5067**  
5 GALLON  
**TITEBOND REGULAR BROWN**  
**TB-31197**  
5 GALLON  
**PREMIUM TITEBOND II**  
**TB-5007**  
5 GALLON



**ORIGINAL TITEBOND PROJUG**  
**TB-50609**  
2.15 GALLON  
**PREMIUM TITEBOND II PROJUG**  
**TB-50009**  
2.15 GALLON



**PUMP**  
**PUMP**

THE "NO MESS" SOLUTION TO FILLING YOUR GLUE BOTTLES. FITS ON GALLONS OR PROJUGS.



### PREMIUM TITEBOND III

TITEBOND III ULTIMATE WOOD GLUE IS THE FIRST ONE-PART, WATER CLEANUP WOOD GLUE EVER OFFERED THAT IS PROVEN WATERPROOF. THE WATERPROOF FORMULA PASSES THE ANSI/HPVA TYPE I WATER-RESISTANCE SPECIFICATION AND OFFERS SUPERIOR BOND STRENGTH, LONGER OPEN ASSEMBLY TIME AND LOWER APPLICATION TEMPERATURE.

**AUTHORIZED DISTRIBUTOR!**



## PLATINUM MAX

ITEM	THICKNESS	FOOT/ROLL	ROLL WIDTH	1 CASE	6 CASES	12 CASES
<b>PLMAX-33</b>	33 MIC EQUIVALANT TO 55 GAUGE	2000 FT/ROLL	18"	\$49.5	\$45.00	\$43.00
<b>PLMAX-43</b>	43 MIC EQUIVALANT TO 70 GAUGE	1500 FT/ROLL	18"	\$49.50	\$45.00	\$43.00
<b>PLMAX-48</b>	48 MIC EQUIVALANT TO 80 GAUGE	1500 FT/ROLL	18"	\$52.00	\$49.00	\$46.00



**PLMAX-33**  
**PLMAX-43**  
**PLMAX-48**

4 ROLLS PER CASE  
PLEASE CALL FOR SKID PRICING

**A REVOLUTIONARY NEW...**

- SILENT WRAP
- HIGHEST PUNCTURE RESISTANCE IN THE INDUSTRY POSSIBLE WITHOUT FILM BREAK
- HIGHER HOLDING FORCE VS. ALL CONVENTIONAL AND MICRON HAND FILMS
- THINNEST/STRONGEST FILM IN THE INDUSTRY (BEAT ALL COMPETITORS)
- TREMENDOUS DOWN GAUGE CAPABILITIES FOR HUGE COST SAVINGS!!

## SPARTAN STRETCH FILM

ITEM	GA COLOR	SIZE	ROLLS/CASE	1 ROLL	1 CASE	3 CASES	10 CASES
<b>SF1880BL</b>	80 BLACK	18" X 1500'	4	\$19.00	\$69.00	\$65.00/CS	\$60.00/CS
<b>SF1880C</b>	80 CLEAR	18" X 1500'	4	\$14.95	\$49.50	\$46.50/CS	\$43.00/CS

PLEASE CALL FOR SKID PRICING



**SF1880BL**  
HEAVY VERY DARK BLACK  
GOOD COVERAGE

**SF1880C**  
HEAVY CLEAR  
GOOD COVERAGE

## GLOBAL HAND FILM

ITEM	STRENGTH	SIZE	ROLLS/CASE	1 ROLL	1 CASE
<b>SF370C</b>	REG. STRENGTH	3" X 1000'	18	\$2.60	\$39.00
<b>SF570C</b>	REG. STRENGTH	5" X 1000'	12	\$4.35	\$42.50
<b>SF3120C</b>	HEAVY DUTY	3" X 700'	18	\$2.60	\$46.00



**SF370C**  
70 CLEAR  
**SF570C**  
70 CLEAR  
**SF3120C**  
120 CLEAR

- GLOBAL COMBINES THE LATEST IN ENHANCED POLYETHYLENE RESINS WITH FIVE-LAYER CAST TECHNOLOGY
- THE PINNACLE OF HAND-APPLIED STRETCH FILMS AVAILABLE
- PUNCTURE RESISTANCE
- UNPARALLELED LOAD HOLDING FORCE
- EXCEPTIONAL TOUGHNESS AND CLING
- BEST IN PERFORMANCE AND VALUE
- CONSISTENT FILM PERFORMANCE
- PRODUCT PROTECTION/REDUCED BREAKS
- TIGHTER PACKAGE/REDUCED SHIFTING
- CAST MANUFACTURING PROCESS
- SUPERIOR LOAD RETENTION

## ROLL DISPENSER

- HANDHELD DISPENSER
- HEAVY DUTY
- FOR 18" STRETCH FILM

ITEM	PRICE
<b>HD5</b>	\$37.00



**HD5**

 ZINC HANGER BOLTS

PART #	SIZE	100 PCS	CASE	CASE QTY
HB142	1/4" X 2" BOLT	\$10.50	\$68.00/M	3,000 PCS
HB143	1/4" X 3" BOLT	\$10.50	\$65.00/M	2,000 PCS
HB144	5/16" X 2 1/2" BOLT	\$10.50	\$57.00/M	1,000 PCS
HB145	5/16" X 3" BOLT	\$11.50	\$67.00/M	1,000 PCS
HB146	5/16" X 3 1/2" BOLT	\$12.75	\$75.75/M	1,000 PCS
HB147	5/16" X 4" BOLT	\$13.00	\$83.95/M	800 PCS
HB148	5/16" X 4 1/2" BOLT	\$13.75	\$79.50/M	800 PCS

 INSERT BITS, 1" L

PART #	DRIVE	PACK QTY	1 PACK	3 PACKS
11760	PHILLIPS #2	10	\$2.50	\$2.25
11760B	PHILLIPS #2	100	\$12.00	\$10.00



CONNECTOR BOLT & NUT

BRONZE FINISH NUT SOLD SEPARATELY

PART #	SIZE	1 PC	100 PCS
CB1430	1/4 20 X 30MM (1.18")	\$0.19	\$13.75
CB1435	1/4 20 X 35MM (1.38")	\$0.20	\$14.75
CB1440	1/4 20 X 40MM (1.57")	\$0.21	\$15.75
CB1445	1/4 20 X 45MM (1.77")	\$0.22	\$16.75
CB1450	1/4 20 X 50MM (1.97")	\$0.23	\$17.75
CB1460	1/4 20 X 60MM (2.36")	\$0.24	\$18.90
CB1470	1/4 20 X 70MM (2.76")	\$0.25	\$19.95
CB1480	1/4 20 X 80MM (3.15")	\$0.26	\$21.20
CB1485	1/4 20 X 85MM (3.35")	\$0.36	\$31.55
CB1490	1/4 20 X 90MM (3.54")	\$0.43	\$38.50
CB14100	1/4 20 X 100MM (3.94")	\$0.65	\$60.65
CB14110	1/4 20 X 110MM (4.33")	\$0.70	\$65.50
JCN-14	1/4 20 X 1/2" NUT	\$0.25	\$19.95
JCN-14K	1/4 20 X 1/2" KNOCK IN NUT	\$0.25	\$19.95
A313	1/4 20 X 9/16" SCREW IN INSERT	\$0.20	\$18.50

WASHERS AND NUTS

PART #	SIZE	100 PCS	1,000 PCS	CASE	CASE QTY
FW1	5/16" X 1 1/4" WASHER	\$6.00	\$15.00/M	\$13.50/M	2,500 PCS
FW2	1/4" X 1" WASHER	\$6.00	\$38.00/M	\$30.00/M	2,375 PCS
FW3	5/16" X 1" WASHER	\$6.00	\$15.75/M	\$12.25/M	5,000 PCS
HN1	5/16" NUT	\$5.00	\$14.50/M	\$12.50/M	4,000 PCS
HN2	1/4" NUT	\$5.00	\$18.00/M	\$15.00/M	7,000 PCS

TWO-PIECE SQUARE INSERT BITS

PART #	DRIVE	PACK QTY	1 PACK	3 PACKS
13147	SQUARE #1	10	\$5.20	\$4.75
13152	SQUARE #2	10	\$5.20	\$4.75

STAINLESS STEEL MAGNETIC BIT HOLDER  
1/4" ONE PIECE HEX SHANK WITH C-RING



PART #	LENGTH	PACK QTY	1 PACK	3 PACKS
12702	2-7/8"	5	\$13.50	\$12.00
14935	6"	5	\$18.50	\$17.50

1/4" HEX SINGLE POWER PHILLIPS DRIVER



PART #	DRIVE	PACK OF 5	PACK OF 20
BIT1	#1 X 1" L	\$2.95	\$6.50
BIT2	#2 X 2" L	\$4.95	\$12.95
BIT6	#2 X 6" L	\$13.95	\$36.95
BIT11	#2 X 1" L	\$2.95	\$6.50

ROBERTSON, 1/4" HEX SQUARE DRIVER



PART #	DRIVE	PACK OF 5	PACK OF 20
BIT135	#1 X 3" L	\$5.95	\$16.50
BIT145	#1 X 4" L	\$6.95	\$18.50
BIT235	#2 X 3" L	\$5.95	\$16.50
BIT245	#2 X 4" L	\$6.95	\$18.50
BIT265	#2 X 6" L	\$8.95	\$22.50

HANGER BOLT DRIVER  
1/4" HEX SHANK



PART #	SIZE	1 PC	5 PCS
12362	1/4 X 20	\$2.75	\$2.40
12363	5/16 X 18	\$3.39	\$2.94
12364	3/8 X 16	\$3.75	\$3.24

MAGNETIC POWER IMPACT BIT



PART #	DRIVE	5 PK	10 PK
12696V5	#2 X 2-3/4"	\$4.50	\$8.50
12697V5	#2 X 3-1/2"	\$5.25	\$9.50

HANGER BOLT, PLAIN

PART #	SIZE	1000+
11229	8 X 32 X 1"	\$20.00/M

YANKEE STYLE DRIVER



PART #	DRIVE	PACK OF 5	5 PACKS
YBIT23LP	#3 PHILLIPS	\$15.00	\$12.00/PACK
YBIT23LS	#2 SQUARE	\$29.00	\$25.00/PACK
YBIT23SP	#2 PHILLIPS	\$15.00	\$12.00/PACK
YBIT23SS	#1 SQUARE	\$30.00	\$25.00/PACK





## ROUND WASHER HEAD QUICKSCREW



FINE THREAD TYPE 17 PLAIN

PART #	SIZE	CASE QTY	1000 PCS	1 CASE	3 CASES
5285	#7 X 1 1/4" SQ-PWH	8,000	\$13.08	\$12.07/M	\$11.68/M
5286	#7 X 1 1/2" SQ-PWH	6,000	\$14.09	\$13.64/M	\$13.08/M

## PHILLIPS OVAL HEAD QUICKSCREW



ANTIQUE BRASS

PART #	SIZE	CASE QTY	1000 PCS	1 CASE
238	#5 X 5/8"	30,000	\$10.05	\$6.06/M
239	#6 X 5/8"	20,000	\$10.05	\$6.51/M



## DRAWER FRONT ADJUSTING SCREWS



LARGE WASHER HEAD COMBO DRIVE TYPE 17 ZINC

PART #	SIZE	CASE QTY	1000 PCS	1 CASE	3 CASES
12624	#8 X 7/8"	8,000	\$13.33	\$11.62/M	\$11.16/M
12625	#8 X 1"	7,000	\$16.36	\$13.64/M	\$13.09/M
12626	#8 X 1 1/8"	6,000	\$17.22	\$14.93/M	\$14.35/M
12627	#8 X 1 1/4"	6,000	\$18.53	\$16.07/M	\$15.45/M
12628	#8 X 1 1/2"	5,000	\$18.89	\$16.37/M	\$15.75/M

## ROUND WASHER HEAD



#2 PHILLIPS/SQUARE DRIVE TYPE 17 CUTTER TIP

PART #	SIZE	1000 PCS	1 CASE
RWH08012B	#8 X 1/2"	\$10.50	\$9.45
RWH08058B	#8 X 5/8"	\$10.50	\$9.45
RWH08034B	#8 X 3/4"	\$11.50	\$10.45
RWH08100B	#8 X 1"	\$11.45	\$10.40
RWH08114B	#8 X 1 1/4"	\$14.18	\$13.13
RWH08112B	#8 X 1 1/2"	\$14.18	\$13.13
RWH08134B	#8 X 1 3/4"	\$16.28	\$15.23
RWH08200B	#8 X 2"	\$17.33	\$16.28
RWH08212B	#8 X 2 1/2"	\$19.43	\$18.38
RWH08300B	#8 X 3"	\$23.10	\$22.05
RWH10100B	#10 X 1"	\$15.23	\$14.18
RWH10114B	#10 X 1 1/4"	\$17.33	\$16.28
RWH10112B	#10 X 1 1/2"	\$18.38	\$17.33
RWH10134B	#10 X 1 3/4"	\$22.05	\$21.00
RWH10200B	#10 X 2"	\$23.10	\$22.05
RWH10212B	#10 X 2 1/2"	\$28.35	\$27.30
RWH10300B	#10 X 3"	\$33.60	\$32.55



## ROUND WASHER HEAD QUICKCUTTERS™

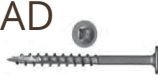

COMBO DRIVE PLAIN

PART #	SIZE	CASE QTY	1000 PCS	1 CASE	3 CASES
7304	#8 X 1"	11,000	\$14.09	\$11.54/M	\$10.93/M
7306	#8 X 1 1/4"	9,000	\$15.10	\$12.82	\$12.13/M
7307	#8 X 1 1/2"	7,000	\$17.12	\$14.42/M	\$13.66/M
7308	#8 X 1 5/8"	6,000	\$18.13	\$15.68/M	\$14.85/M
7309	#8 X 1 3/4"	5,000	\$19.14	\$16.38/M	\$15.51/M
7310	#8 X 2"	4,000	\$20.15	\$17.79/M	\$16.84/M
7311	#8 X 2 1/4"	3,000	\$23.18	\$20.30/M	\$19.22/M
7312	#8 X 2 1/2"	2,500	\$25.25	\$23.38/M	\$22.14/M

## HARDENED HEX LAG BOLT

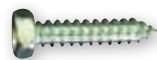

USE WITH BED HARDWARE

PART #	SIZE	100 PCS	1000 PCS	5000 PCS
LB112	5/16" X 1 1/2"	\$11.00	\$95.00/M	\$90.00/M

## RUBBER HEAD COVERS



PART #	100 PCS	1000 PCS
BC12	\$8.00	\$52.00

CAN BE USED WITH BED HARDWARE



## FLAT HEAD & ROUND WASHER HEAD QUICKCUTTERS™ ZINC



PART #	SIZE	CASE QTY	1000 PCS	1 CASE
7927	#10 X 2 1/2"	1,500	\$39.39	\$35.10/M
7935	#10 X 3"	1,500	\$45.45	\$40.03/M
7936	#10 X 3 1/2"	1,000	\$60.60	\$55.67/M
7937	#10 X 4"	1,000	\$75.75	\$69.30/M



## ULTIMATE FURNITURE SCREW, COMBO DRIVE

PART #	SIZE	CASE QTY	1000 PCS	1 CASE
UFS06058B	#6 X 5/8"	10,000	\$11.95	\$7.75
UFS06034B	#6 X 3/4"	10,000	\$11.95	\$7.75
UFS06100B	#6 X 1"	10,000	\$12.95	\$8.65
UFS06114B	#6 X 1 1/4"	10,000	\$13.95	\$9.95
UFS06112B	#6 X 1 1/2"	10,000	\$14.95	\$10.95
UFS08100B	#8 X 1"	10,000	\$13.50	\$9.50
UFS08114B	#8 X 1 1/4"	8,000	\$14.95	\$10.95
UFS08112B	#8 X 1 1/2"	15,000	\$15.95	\$11.95
UFS08134B	#8 X 1 3/4"	4,000	\$17.95	\$13.75
UFS08200B	#8 X 2"	4,000	\$19.95	\$15.75
UFS08212B	#8 X 2 1/2"	3,000	\$22.95	\$19.95
UFS08300B	#8 X 3"	2,500	\$24.95	\$20.95
UFS010114B	#10 X 1 1/4"	5,000	\$18.95	\$12.75
UFS010200B	#10 X 2"	3,000	\$21.95	\$18.75
UFS010212B	#10 X 2 1/2"	2,500	\$27.95	\$22.75
UFS10312B	#10 X 3 1/2"	1,000		\$37.50

## SLIDE SCREW

#2 SQUARE DRIVE TRUSS HEAD QUICKSCREW ZINC



PART #	SIZE	CASE QTY	100 PCS	1000 PCS	1 CASE
SQ-6716	#6 X 7/16	15,000	\$1.52	\$13.08	\$12.07/M
SQ-6712	#6 X 1/2	15,000	\$1.52	\$13.08	\$12.07/M

#2 RECES SQUARE DRIVE TRUSS HEAD QUICKSCREW BLACK



PART #	SIZE	COLOR	CASE QTY	100 PCS	1000 PCS	1 CASE
SQ6076-BL	#6 X 5/8"	BLACK	15,000	\$2.53	\$11.06	\$9.60/M
SQ6077-BL	#6 X 3/4"	BLACK	15,000	\$3.03	\$11.06	\$9.60/M



COMBINATION DRIVE QUICKSCREW PHILLIPS-RWH LOW PROFILE

PART #	SIZE	COLOR	CASE QTY	1000 PCS	1 CASE
5213	#8 X 7/16"	ZINC	20,000	\$10.05	\$7.02/M
4688	#8 X 1/2"	ZINC	14,000	\$10.05	\$7.02/M
9440	#8 X 1/2"	BLACK	14,000	\$10.95	\$7.50/M
9441	#8 X 19/32"	BLACK	14,000	\$10.95	\$7.50/M



## MACHINE SCREWS

PHILLIPS SLOTTED COMBO DRIVE, TRUSS HEAD ZINC

PART #	SIZE	CASE QTY	100 PCS	1000 PCS	1 CASE
308	#8-32 X 1/2"	14,000	\$2.00	\$9.95	\$8.00/M
309	#8-32 X 5/8"	12,000	\$2.00	\$9.95	\$8.00/M
310	#8-32 X 3/4"	10,000	\$2.00	\$9.95	\$8.00/M
311	#8-32 X 7/8"	8,500	\$2.00	\$9.95	\$8.00/M
312	#8-32 X 1"	7,000	\$2.25	\$10.00	\$9.00/M
313	#8-32 X 1 1/8"	6,500	\$2.50	\$10.95	\$9.85/M
314	#8-32 X 1 1/4"	5,500	\$2.75	\$11.95	\$10.95/M
315	#8-32 X 1 3/8"	5,000	\$2.75	\$11.95	\$11.25/M
316	#8-32 X 1 1/2"	5,000	\$3.00	\$12.95	\$11.95/M
317	#8-32 X 1 5/8"	4,000	\$3.00	\$12.95	\$12.50/M
318	#8-32 X 1 3/4"	4,000	\$3.25	\$13.95	\$13.00/M
319	#8-32 X 1 7/8"	3,000	\$3.50	\$14.50	\$13.50/M
320	#8-32 X 2"	3,000	\$3.75	\$15.95	\$14.95/M



## #2 SQUARE DRIVE TRUSS HEAD QUICKSCREW

TYPE 17 ZINC



PART #	SIZE	CASE QTY	1000 PCS	1 CASE
13581	#8 X 5/8"	10,000	\$12.07	\$10.05/M
13582	#8 X 3/4"	10,000	\$12.07	\$10.05/M

## BACK SCREW



## DRAWER SLIDE SCREW

COMBINATION TRUSS DRIVE QUICKSCREW

PART #	SIZE	COLOR	CASE QTY	1000 PCS	1 CASE
10256	#8 X 7/16"	BLACK	20,000	\$10.05	\$7.58/M
10255	#8 X 7/16"	ZINC	20,000	\$10.05	\$7.58/M



## HINGE & BACK QUICKSCREW

COMBO-RWH TYPE 17 PLAIN



PART #	SIZE	COLOR	CASE QTY	1000 PCS	1 CASE
<b>7379</b>	#8 X 5/8"	PLAIN	10,000	\$12.07	\$8.53/M
<b>7380</b>	#8 X 3/4"	PLAIN	10,000	\$12.07	\$9.75/M

PH-TRUSS TYPE 17



PART #	SIZE	COLOR	CASE QTY	1000 PCS	1 CASE
<b>6802</b>	#8 X 3/4"	ZINC	10,000	\$12.07	\$9.73/M
<b>7892</b>	#8 X 5/8"	ZINC	10,000	\$12.07	\$8.87/M
<b>8080</b>	#8 X 5/8"	ANTIQU BRASS	10,000	\$13.08	\$11.45/M



## UNDERCUT FOR HINGES

PHILLIPS QUICKSCREW - PH-FL UC #6 TYPE 17



PART #	SIZE	COLOR	CASE QTY	1000 PCS	1 CASE
<b>6055</b>	#6 X 7/16"	ZINC	35,000	\$10.05	\$5.30/M
<b>6056</b>	#6 X 1/2"	ZINC	25,000	\$10.05	\$5.59/M
<b>6057</b>	#6 X 5/8"	ZINC	25,000	\$10.05	\$5.82/M
<b>6063</b>	#6 X 5/8"	ANTIQU BRASS	25,000	\$10.05	\$7.59/M



## PHILLIPS FLAT HEAD QUICKSCREW

TYPE 17 ZINC



PART #	SIZE	CASE QTY	1000 PCS	1 CASE
<b>9014</b>	#6 X 1/2"	25,000	\$10.05	\$5.01/M
<b>9015</b>	#6 X 5/8"	25,000	\$10.05	\$5.43/M
<b>9016</b>	#6 X 3/4"	20,000	\$10.05	\$5.73/M
<b>9017</b>	#8 X 5/8"	14,000	\$10.05	\$6.01/M
<b>9018</b>	#8 X 3/4"	12,000	\$10.05	\$7.73/M
<b>9770</b>	#9 X 3/4"	10,000	\$10.05	\$8.59/M



## #2 SQUARE DRIVE, FLAT HEAD QUICKSCREW

TYPE 17 ZINC



PART #	SIZE	CASE QTY	1000 PCS	1 CASE
<b>13465</b>	#6 X 1/2"	25,000	\$10.05	\$5.43/M
<b>13466</b>	#6 X 5/8"	25,000	\$10.05	\$5.63/M
<b>13467</b>	#6 X 3/4"	20,000	\$10.05	\$6.08/M
<b>13468</b>	#6 X 1"	13,000	\$10.05	\$7.25/M
<b>13469</b>	#6 X 1 1/4"	10,000	\$11.06	\$7.70/M
<b>13470</b>	#6 X 1 1/2"	8,000	\$11.06	\$9.04/M



## PHILLIPS FLAT HEAD QUICKSCREW

PHILLIPS-FLAT



PART #	SIZE	COLOR	CASE QTY	1000 PCS	1 CASE
<b>1623</b>	#6 X 1/2"	BLACK	25,000	\$10.05	\$5.00/M
<b>4722</b>	#6 X 5/8"	BRIGHT BRASS	25,000	\$10.05	\$6.31/M
<b>232</b>	#6 X 1/2"	ANTIQU BRASS	25,000	\$10.05	\$8.03/M
<b>235</b>	#6 X 5/8"	ANTIQU BRASS	25,000	\$10.05	\$8.03/M
<b>236</b>	#6 X 3/4"	ANTIQU BRASS	20,000	\$10.05	\$8.03/M
<b>119</b>	#6 X 5/8"	BLACK	25,000	\$10.05	\$6.01/M
<b>110</b>	#5 X 5/8"	ZINC	30,000	\$10.05	\$6.01/M



# PHILLIPS PAN HEAD QUICKSCREW

TYPE 17



BLACK



ZINC



ANTIQUE BRASS

PART #	SIZE	COLOR	CASE QTY	1000 PCS	1 CASE
144	#6 X 1/2"	BLACK	30,000	\$7.02	\$5.00/M
146	#6 X 3/4"	BLACK	20,000.	\$7.32	\$6.16/M
5173	#6 X 1"	BLACK	15,000	\$8.03	\$7.14/M
6882	#8 X 1/2"	BLACK	15,000	\$8.03	\$6.82/M
147	#8 X 5/8"	BLACK	12,000	\$9.60	\$8.14/M
148	#8 X 3/4"	BLACK	10,000	\$9.60	\$8.42/M
8083	#6 X 1/2"	ZINC	30,000	\$10.05	\$8.27/M
8084	#6 X 5/8"	ZINC	25,000	\$10.05	\$8.42/M
8085	#8 X 5/8"	ZINC	12,000	\$10.05	\$9.04/M
8086	#8 X 3/4"	ZINC	10,000	\$11.06	\$9.71/M
8081	#6 X 1/2"	ANTIQUE BRASS	30,000	\$10.05	\$8.85/M
8082	#6 X 5/8"	ANTIQUE BRASS	25,000	\$11.06	\$9.71/M
7891	#8 X 5/8"	ANTIQUE BRASS	12,000	\$13.08	\$11.70/M



# #2 SQUARE DRIVE, FLAT HEAD QUICKSCREW

COMBO SQUARE PHILLIPS TYPE 17 WITH NIBS BLACK



SQUARE TYPE 17 WITH NIBS ZINC



PART #	SIZE	CASE QTY	1000 PCS	1 CASE	3 CASES
1246	#8 X 1"	11,000	\$11.06	\$9.24/M	\$8.60/M
1249	#8 X 1 1/4"	9,000	\$12.07	\$10.65/M	\$9.89/M
1251	#8 X 1 1/2"	7,000	\$14.09	\$12.58/M	\$12.14/M
1253	#8 X 1 5/8"	6,000	\$15.10	\$13.92/M	\$13.41/M
10115	#8 X 1 3/4"	5,000	\$17.12	\$14.56/M	\$14.02/M
1255	#8 X 2"	4,000	\$18.13	\$16.56/M	\$15.98/M
5447	#8 X 2 1/4"	3,000	\$21.16	\$18.32/M	\$17.32/M
1257	#9 X 2 1/2"	2,500	\$28.23	\$25.06/M	\$23.20/M
1259	#9 X 3"	2,000	\$30.25	\$27.49/M	\$26.21/M

PART #	SIZE	CASE QTY	1000 PCS	1 CASE	3 CASES
12613	#8 X 1"	11,000	\$10.05	\$8.38/M	\$8.08/M
13360	#8 X 1 1/8"	10,000	\$10.30	\$9.27/M	\$8.93/M
12614	#8 X 1 1/4"	9,000	\$11.17	\$10.05/M	\$9.30/M
12615	#8 X 1 1/2"	7,000	\$13.26	\$11.93/M	\$11.05/M
12616	#8 X 1 5/8"	6,000	\$14.29	\$12.87/M	\$11.92/M
12617	#8 X 1 3/4"	5,000	\$15.18	\$13.67/M	\$12.65/M
12618	#8 X 2"	4,000	\$16.11	\$14.42/M	\$13.39/M
12619	#8 X 2 1/4"	3,000	\$20.15	\$17.81/M	\$16.49/M
12620	#9 X 2 1/2"	2,500	\$24.59	\$22.13/M	\$20.49/M
12621	#9 X 3"	2,000	\$27.78	\$24.98/M	\$23.15/M
12622	#10 X 3 1/2"	1,500	\$43.53	\$39.18/M	\$36.27/M
12623	#10 X 4"	1,000	\$46.45	\$46.45/M	\$46.02/M





SQUARE DRIVE

PAN HEAD QUICKSCREWS



ZINC



ANTIQUÉ BRASS

PART #	SIZE	COLOR	CASE QTY	1000 PCS	1 CASE
<b>13579</b>	#8 X 5/8"	ZINC	12,000	\$10.05	\$9.04/M
<b>13580</b>	#8 X 3/4"	ZINC	10,000	\$11.06	\$10.05/M

PAN HEAD #1 RECEX SQUARE DRIVE



PART #	SIZE	COLOR	CASE QTY	100 PCS	1000 PCS	1 CASE
<b>SQ74-AB</b>	#6 X 1/2"	ANTIQUÉ BRASS	15,000	\$2.02	\$11.06	\$8.59/M
<b>SQ76-AB</b>	#6 X 5/8"	ANTIQUÉ BRASS	15,000	\$2.53	\$13.08	\$9.60/M



FACE FRAME AND POCKETHOLE ASSEMBLY SCREWS,  
PLAIN QUICKSCREW

TYPE 17 PLAIN



FINE THREAD



COARSE THREAD



HI-LO THREAD

PART #	SIZE	THREAD	CASE QTY	1000 PCS	1 CASE	3 CASES
<b>13003</b>	#6 X 1" SQ-PN	FINE	10,000	\$13.95	11.95/M	\$9.95/M
<b>2722</b>	#6 X 1 1/4" SQ-PN	FINE	8,000	\$11.95	9.95/M	\$9.50/M
<b>2724</b>	#6 X 1 1/2" SQ-PN	FINE	7,000	\$13.50	10.40/M	\$10.49/M
<b>4082</b>	#6 X 1 1/4" SQ-PN	FINE	8,000	\$13.75	11.40/M	\$11.16/M
<b>5215</b>	#6 X 1 1/2" SQ-PN	FINE	7,000	\$13.95	11.95/M	\$11.60/M
<b>4080</b>	#7 X 1 1/4" SQ-PN	COARSE	8,000	\$13.50	\$10.25/M	\$9.95/M
<b>4081</b>	#7 X 1 1/2" SQ-PN	COARSE	7,000	\$13.75	\$11.25/M	\$10.90/M
<b>4084</b>	#7 X 1 1/4" SQ-PN	HI-LO	8,000	\$12.95	\$9.95/M	\$9.70/M
<b>4085</b>	#7 X 1 1/2" SQ-PN	HI-LO	7,000	\$13.95	\$11.50/M	\$10.95/M

FACE FRAME AND POCKETHOLE ASSEMBLY SCREWS

TYPE 17 ZINC



FINE THREAD



COARSE THREAD



HI-LO THREAD

PART #	SIZE	THREAD	CASE QTY	1000 PCS	1 CASE
<b>FF-6114</b>	#6 X 1 1/4" SQ-PN	FINE	8,000	\$14.65	\$11.06/M
<b>FF-6112</b>	#6 X 1 1/2" SQ-PN	FINE	7,000	\$14.65	\$11.06/M
<b>FC-6114</b>	#6 X 1 1/4" SQ-PN	COARSE	8,000	\$14.65	\$11.06/M
<b>FC-6112</b>	#6 X 1 1/2" SQ-PN	COARSE	7,000	\$14.65	\$11.06/M
<b>FF6114HL</b>	#6 X 1 1/4" SQ-PN	HI-LO	8,000	\$14.65	\$11.06/M
<b>FF6112HL</b>	#6 X 1 1/2" SQ-PN	HI-LO	7,000	\$14.65	\$11.06/M





## Router Bits & Saw Blades

### AMANA TOOL - CARBIDE TIPPED BORING BITS

Item	Diameter (D)	Cutting Height (B)	Shank (d)	Overall Length (L)	Rotation
<b>BRAD POINT BORING BITS</b>					
201005	5mm	27mm	10mm	57mm	RH
301005	5mm	27mm	10mm	57mm	LH
201008	8mm	27mm	10mm	57mm	RH
301008	8mm	27mm	10mm	57mm	LH
<b>HINGE BORING BIT - 35mm</b>					
203351	35mm		10mm	57mm	RH

ITEM	1 PC.	ITEM	1 PC.
201005	\$7.50	301008	\$9.06
301005	\$7.50	203351	\$24.95
201008	\$9.06		



Brad Point -  
Right Hand Rotation



Hinge Boring

### CARBIDE TIPPED 3-PC HINGE BORING SET - ITEM NO. **HBM-102**

#### HBM-102 Set Contains:

- One 35mm right hand hinge boring bit (Item No. 203351 - see above for specs)
- Two 8mm left hand brad point boring bits (Item No. 301008 - see above for specs)

Complete hinge installation set for boring machines.

ITEM	1 PC.
HBM-102	\$43.06

### AMANA TOOL - CARBIDE TIPPED SAW BLADES

Item	Diameter	Teeth	Grind	Bore	Thickness	Kerf	Application
PR1040	10" (250MM)	40	ATB	5/8"	.102" (2.6mm)	.135 (3.4mm)	Crosscut / Rip - Solid Wood, Plywood, MDF & Chipboard
610504	10" (250MM)	50	4&1	5/8"	.095 (2.4mm)	.135 (3.4mm)	Crosscut / Rip - Hardwood, Softwood & Plywood
610600	10" (250MM)	60	ATB	5/8"	.087 (2.2mm)	.126 (3.2mm)	Cut-off / Crosscut - Hardwood, Softwood, Plywood. Chipboard
610601	10" (250MM)	60	TCG	5/8"	.087 (2.2mm)	.126 (3.2mm)	Hardwood, Softwood, Plywood, Composition & Double-Sided Plastic Laminated Material
610800	10" (250MM)	80	ATB	5/8"	.087 (2.2mm)	.126 (3.2mm)	Hardwood, Softwood, Veneers, Laminates, Plywood & Chipboard
RB1020	10" (250MM)	20	FT	5/8"	.087 (2.2mm)	.126 (3.2mm)	Euro-Rip - Rip Hardwood, Softwood - Anti-Kickback
MB10800	10" (250MM)	80	H-ATB	5/8"	.102" (2.6mm)	.126 (3.2mm)	Double Sided Melamine & Laminate / High ATB For Chip Free Cuts

ITEM	1 PC.
PR1040	\$61.85
610504	\$60.71
610600	\$55.50
610601	\$55.64
610800	\$84.29
RB1020	\$53.40
MB10800	\$81.06



# PR1040



# RB1020



# MB10800



# 610601



More Amana Router Bits & Saw Blades Are Available!  
Please Call Us If You Don't See What You Are Looking For!

## Router Bits & Saw Blades

### AMANA TOOL - CARBIDE TIPPED ROUTER BITS

Item	Diameter (D)	Cutting Height (B)	Shank (d)	Overall Length (L)	Replacement Bearing #	Collar #
<b>FLUSH TRIM PLUNGE TEMPLATE BIT - 2 Flute</b>						
45460	1/2	1	1/4	2-1/2	47701	47724
<b>FLUSH TRIM PLUNGE TEMPLATE &amp; DADO CLEAN-OUT BIT - 2 Flute</b>						
45460-S	1/2	1/4	1/4	1-5/8	47701	47724
<b>FLUSH TRIM BITS - 2 Flute</b>						
47090	1/4	1/2	1/4	2-1/4	47723	
47092	1/4	1	1/4	2-1/2	47723	
47100	3/8	1	1/4	2-5/8	47702	
47104	1/2	1	1/4	2-5/8	47706	
<b>FLUSH TRIM BITS - 3 Flute</b>						
47114	1/2	1	1/4	2-5/8	47706	
<b>STRAIGHT PLUNGE / HIGH PRODUCTION BITS - 2 Flute</b>						
45210	1/4	1	1/4	2-1/4		
45420	1/2	1-1/4	1/2	2-7/8		

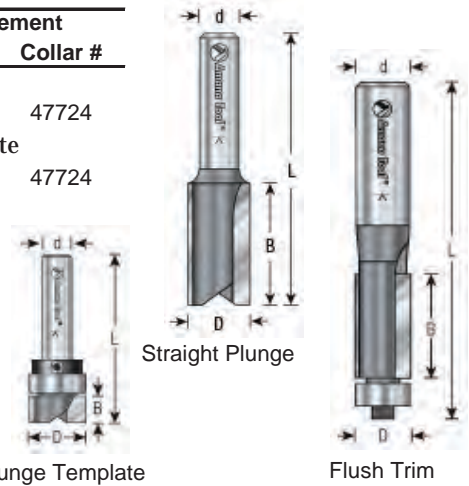

Item	Diameter (D)	Cutting Height (B)	Shank (d)	Overall Length (L)	Replace Bearing #	Radius (R)	D1
<b>NO-FILE TRIM BIT - 2 Flute</b>							
47150	1/2	3/8	1/4	1-7/8	47704	.059 (1.5mm)	
<b>CORNER ROUNDING BITS - 2 Flute</b>							
49496	3/4	3/8	1/4	2	47706	1/8	1/2
49504	1	1/2	1/4	2	47706	1/4	1/2
49512	1-1/4	5/8	1/4	2-3/16	47706	3/8	1/2
49516	1-1/2	3/4	1/4	2-1/4	47706	1/2	1/2

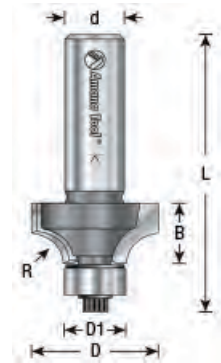

### AMANA TOOL - SOLID CARBIDE ROUTER BITS

Item	Diameter (D)	Cutting Height (B)	Shank (d)	Overall Length (L)	Replace Bearing #	B1
<b>INVECTRA ALUMINUM LAMINATE TRIM BITS - 2 Flute</b>						
51430	1/4	5/8	1/4	2-3/8	47723 (2)	
51432	1/2	5/8	1/2	3-1/4	47706	
<b>COMPRESSION SPIRAL CNC ROUTER BITS - 2 Flute</b>						
46188	1/2	1-1/4	1/2	3		11mm
46190	1/2	1-5/8	1/2	3-1/2		13mm

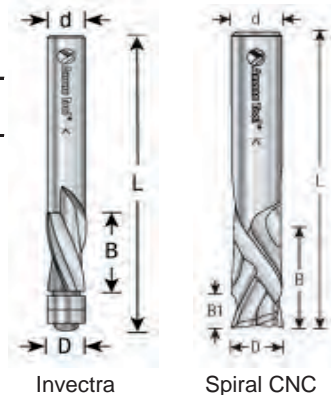

ITEM	1 PC.
45460	\$18.32
45460-S	\$18.93
47090	\$17.03
47092	\$17.71
47100	\$11.83
47104	\$11.62

ITEM	1 PC.
47114	\$16.90
45210	\$10.35
45420	\$11.83
47150	\$19.06
49496	\$18.99
49504	\$20.22

ITEM	1 PC.
49512	\$27.26
49516	\$31.97
51430	\$48.88
51432	\$82.94
46188	\$56.41
46190	\$67.85



## 18 GAUGE BRAD NAILER

- BRAD SIZE: 1/2" TO 2" LENGTH
- MULTI-ANGLE NAILING. DRIVES NAILS AT ALMOST ANY ANGLE.
- SMALL DRIVER TIP FOR MINIMAL HOLE SIZE AND FILLING
- AUTO TRIGGER LOCKOUT PROTECTS YOUR TOOL & PROJECT
- DEPTH CONTROL DIAL FOR ACCURATE NAIL SETTING
- POSIT-LOCK NOSE COVER DESIGNED FOR TIGHT TOLERANCES
- DUAL FIRING OPTIONS SEQUENTIAL OR CONTACT FIRING
- BELT HOOK KEEPS TOOL READY BY YOUR SIDE
- SWIVEL AIR COUPLER KEEPS AIR HOSE TANGLE-FREE
- WEIGHT: 3.2 LB.
- DIMENSIONS: 9.5" L X 9.3" H X 2" W

ITEM	MODEL	1+
<b>1850GB</b>	<b>AIR MODEL</b>	\$198.00
<b>GC1850</b>	<b>CORDLESS</b>	\$438.00
<b>GFC01-04</b>	<b>CORDLESS FUEL CARTRIDGE</b>	\$6.25



## 16 GAUGE BRAD NAILER

- BRAD SIZE: 3/4" - 2-1/2" LENGTH
- WEIGHT: 4.7 LBS.
- 20+ YEARS PROVEN DESIGN THAT PROS HAVE COME TO RELY ON
- LIGHTWEIGHT DIECAST BODY LETS YOU KEEP GOING ALL DAY
- DEPTH CONTROL DIAL FOR ACCURATE NAIL SETTING
- QUICK RELEASE NOSE COVER FOR QUICK AND EASY JAM CLEARING
- RUBBER NO-MAR TIP PREVENTS MARRING OF WORK SURFACE
- 360° ROTATABLE EXHAUST COVER DIRECTS EXHAUST IN ANY DIRECTION

ITEM	1+
<b>1664</b>	\$159.00



## 18 GAUGE 1/4" CROWN STAPLER

- THE EXTRA POWERFUL MOTOR HANDLES HEAVY DUTY USE; MAKING IT EASY TO DRIVE UP TO 1-9/16" STAPLES INTO HARDWOODS
- NAIL RANGE: 1/2" - 1-9/16" LENGTH
- WEIGHT: 4.1 LBS.
- DIMENSIONS: 12.5" L X 9.25" H X 3" W
- 20+ YEARS PROVEN DESIGN THAT PROS HAVE COME TO RELY ON
- LIGHTWEIGHT DIECAST BODY LETS YOU KEEP GOING ALL DAY
- QUICK RELEASE NOSE COVER FOR QUICK AND EASY JAM CLEARING
- 360° ROTATABLE EXHAUST COVER DIRECTS EXHAUST IN ANY DIRECTION

ITEM	1+
<b>9040</b>	\$168.00



## 18 GAUGE NARROW CROWN EG STAPLES



- MADE TO FIT PASLODE AND DUOFAST, HITACHI, SENCO, SPOTNAIL, AND MORE
- SOLD ONLY IN FULL BOX
- GALVANIZED

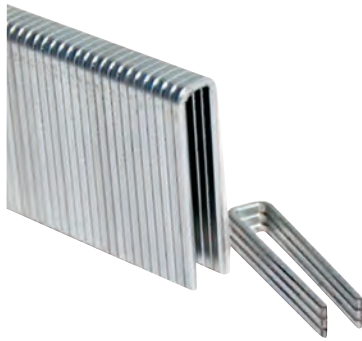

1/4" CROWN

ITEM	SIZE	BOX QTY	1 BOX	1 CASE (10 BOXES)
NCS14012G	1/4 X 1/2"	5,000	\$8.95	\$8.33
NCS14058G	1/4 X 5/8"	5,000	\$10.25	\$9.51
NCS14034G	1/4 X 3/4"	5,000	\$11.78	\$10.91
NCS14078G	1/4 X 7/8"	5,000	\$13.52	\$12.51
NCS14100G	1/4 X 1"	5,000	\$15.27	\$14.13
NCS14118G	1/4 X 1 1/8"	5,000	\$16.36	\$15.14
NCS14114G	1/4 X 1 1/4"	5,000	\$17.45	\$16.15
NCS14138G	1/4 X 1 3/8"	5,000	\$18.73	\$17.34
NCS14112G	1/4 X 1 1/2"	5,000	\$20.00	\$18.52

## 18 GAUGE BRAD NAILS

ITEM	SIZE	BOX QTY	1 BOX	1 CASE (10 BOXES)
BN18012G	1/2"	5,000	\$7.78	\$7.33
BN18058G	5/8"	5,000	\$8.28	\$7.83
BN18034G	3/4"	5,000	\$8.98	\$8.49
BN18078G	7/8"	5,000	\$9.28	\$8.78
BN18100G	1"	5,000	\$9.59	\$9.06
BN18118G	1 1/8"	5,000	\$10.25	\$9.68

- MADE TO FIT SENCO, HITACHI, PASLODE, PORTER CABLE, BOSTITCH, AND MOST 18 GAUGE NAILERS
- SOLD IN FULL BOX
- GALVANIZED

ITEM	SIZE	BOX QTY	1 BOX	1 CASE (10 BOXES)
BN181316G	1 3/16"	5,000	\$10.58	\$10.00
BN18114G	1 1/4"	5,000	\$10.90	\$10.30
BN18138G	1 3/8"	5,000	\$11.78	\$11.13
BN18112G	1 1/2"	5,000	\$12.65	\$11.95
BN181916G	1 9/16"	5,000	\$12.93	\$12.22
BN18134G	1 3/4"	5,000	\$13.78	\$13.02
BN18200G	2"	5,000	\$14.83	\$14.01



## 16 GAUGE FINISH NAILS

- MADE TO FIT SENCO, HITACHI, PASLODE, PORTER CABLE, BOSTITCH, AND MOST 16 GAUGE NAILERS
- SOLD IN FULL BOX
- GALVANIZED

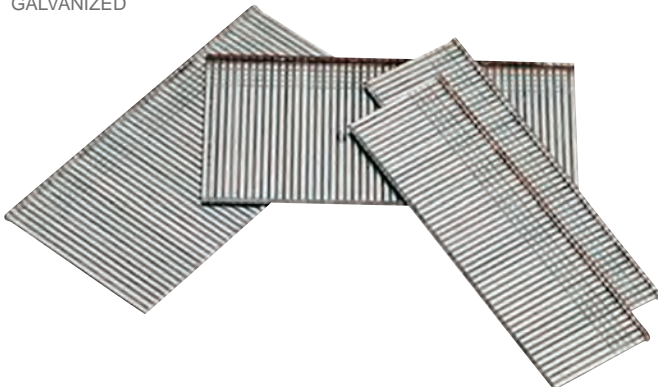

ITEM	SIZE	BOX QTY	1 BOX	1 CASE (10 BOXES)
FN16058G	5/8"	5,000	\$10.50	\$9.85
FN16034G	3/4"	5,000	\$11.25	\$10.50
FN16078G	7/8"	5,000	\$11.96	\$11.25
FN16100G	1"	5,000	\$13.56	\$12.75
FN16118G	1 1/8"	5,000	\$13.96	\$13.10
FN16114G	1 1/4"	5,000	\$17.47	\$16.45
FN16112G	1 1/2"	2,500	\$10.47	\$9.85
FN16134G	1 3/4"	2,500	\$11.87	\$11.15
FN16200G	2"	2,500	\$12.49	\$11.75
FN16214G	2 1/4"	2,500	\$13.62	\$12.80



## EMERALD GREEN FILM BACK

- FOR SANDING WOOD, METAL, FIBERGLASS AND SOLID SURFACE
- IDEAL FOR DISC AND ORBITAL MACHINE SANDING
- AVAILABLE WITH PSA, HOOK & LOOP, AND PLAIN FILM BACKING



- GRAIN: ALUMINUM OXIDE
- BACKING: FILM
- BONDING: RESIN OVER RESIN
- COATING: SEMI-OPEN
- STERATE: YES

### 5X 0X 0 PSA SQ TAB

ITEM	GRIT	1+	1 CASE, 10 BOXES, 100 DISCS/BOX
M146207	80 GRIT	\$0.47	\$0.42
M145944	100 GRIT	\$0.36	\$0.32
M144187	120 GRIT	\$0.36	\$0.32
M144186	150 GRIT	\$0.36	\$0.32
M143770	180 GRIT	\$0.36	\$0.32
M144513	220 GRIT	\$0.36	\$0.32

### 5X 0X 0 HOOK & LOOP

ITEM	GRIT	1+	1 CASE, 10 BOXES, 100 DISCS/BOX
M146177	80 GRIT	\$0.50	\$0.44
M146178	100 GRIT	\$0.47	\$0.42
M144706	120 GRIT	\$0.47	\$0.42
M144705	150 GRIT	\$0.46	\$0.41
M144704	180 GRIT	\$0.46	\$0.41
M144703	220 GRIT	\$0.51	\$0.46

## FILMTEK

- FOR SANDING WOOD, METAL, AUTOMOTIVE, MARINE AND SOLID SURFACE
- IDEAL FOR DISC AND ORBITAL MACHINE SANDING
- AVAILABLE WITH PSA AND HOOK & LOOP
- TEAR-RESISTANT FILM BACKING
- LONGER LIFETIME
- ECONOMICAL FILM MATERIAL
- CLOG RESISTANCE
- STEARATED TO MINIMIZE LOADING
- FAST CUT, CONSISTENT FINISH

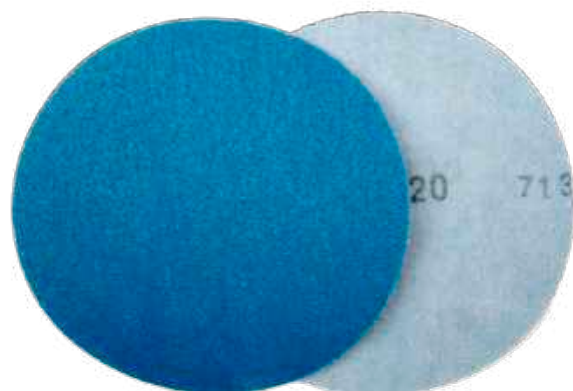

### 5" PSA STICKY DISC

ITEM	GRIT	DISCS PER BOX	BOXES PER CASE	BOX PRICE	CASE PRICE
M-172791	80 GRIT	100	10	\$0.23	\$0.20
M-172793	100 GRIT	100	10	\$0.21	\$0.19
M-172785	120 GRIT	100	10	\$0.21	\$0.19
M-172786	150 GRIT	100	10	\$0.21	\$0.19
M-172787	180 GRIT	100	10	\$0.21	\$0.19
M-173142	220 GRIT	100	10	\$0.21	\$0.19
M-172792	240 GRIT	100	10	\$0.21	\$0.19
M-173434	320 GRIT	100	10	\$0.21	\$0.19

### 5" HOOK & LOOP X NO HOLE

ITEM	GRIT	DISCS PER BOX	BOXES PER CASE	BOX PRICE	CASE PRICE
M-172854	80 GRIT	100	10	\$0.28	\$0.25
M-172794	100 GRIT	100	10	\$0.26	\$0.24
M-172788	120 GRIT	100	10	\$0.26	\$0.24
M-172789	150 GRIT	100	10	\$0.26	\$0.24
M-172790	180 GRIT	100	10	\$0.26	\$0.24
M-174565	220 GRIT	100	10	\$0.26	\$0.24
M-172857	240 GRIT	100	10	\$0.26	\$0.24
M-172855	320 GRIT	100	10	\$0.26	\$0.24



## UNEEDA ENTERPRISES EKABLUE & EKAWHITE DISCS

- PREMIUM ALUMINUM OXIDE GRAIN
- RESIN OVER RESIN BONDED
- "B" WEIGHT LATEX PAPER
- FOR HAND SANDING OF ALL WOODS, LACQUER AND PAINTED SURFACES
- LATEX BACKING GREATLY REDUCES EDGE WEAR
- COMPARE TO: 3M GOLD, MIRKA GOLD, NORTON CHAMPAGNE AND CARBO RED



### EKABLUE 5" PSA STICKY DISCS X NO HOLE

ITEM	GRIT	DISCS PER BOX	BOXES PER CASE	BOX PRICE	CASE PRICE
M130565	80 GRIT	125	8	\$0.20	\$0.18
M130617	100 GRIT	125	8	\$0.20	\$0.17
M130566	120 GRIT	125	8	\$0.20	\$0.17
M129500	150 GRIT	125	8	\$0.20	\$0.17
M129501	180 GRIT	250	8	\$0.20	\$0.17
M129502	220 GRIT	250	8	\$0.20	\$0.17
M131726	320 GRIT	250	8	\$0.20	\$0.17

### EKABLUE 5" HOOK & LOOP X NO HOLE

ITEM	GRIT	DISCS PER BOX	BOXES PER CASE	BOX PRICE	CASE PRICE
M130024	80 GRIT	100	10	\$0.26	\$0.24
M129437	100 GRIT	100	10	\$0.26	\$0.22
M129438	120 GRIT	100	10	\$0.26	\$0.22
M128880	150 GRIT	100	10	\$0.26	\$0.22
M128366	180 GRIT	100	10	\$0.26	\$0.22
M128930	220 GRIT	100	10	\$0.26	\$0.22

### EKAWHITE 5" PSA STICKY DISCS X NO HOLE

ITEM	GRIT	DISCS PER BOX	BOXES PER CASE	BOX PRICE	CASE PRICE
M130652	80 GRIT	100	10	\$0.21	\$0.20
M130653	100 GRIT	100	10	\$0.21	\$0.18
M130654	120 GRIT	100	10	\$0.21	\$0.18
M130589	150 GRIT	100	10	\$0.21	\$0.18
M130590	180 GRIT	100	10	\$0.21	\$0.18
M130591	220 GRIT	100	10	\$0.21	\$0.18

### EKAWHITE 5" HOOK & LOOP X NO HOLE

ITEM	GRIT	DISCS PER BOX	BOXES PER CASE	BOX PRICE	CASE PRICE
M134339	80 GRIT	100	10	\$0.29	\$0.26
M134340	100 GRIT	100	10	\$0.28	\$0.24
M132617	120 GRIT	100	10	\$0.28	\$0.24
M132618	150 GRIT	100	10	\$0.28	\$0.24
M130557	180 GRIT	100	10	\$0.28	\$0.24
M130558	220 GRIT	100	10	\$0.28	\$0.24

## EKA500 DISCS

- VERY FLEXIBLE J-WT. CLOTH DISC
- EXCELLENT FINISH AND DISC LIFE
- LONG LIFE EDGE WEAR
- COMPARE TO: ANY CLOTH DISC MATERIAL



### 5" PSA STICKY DISCS X NO HOLE

ITEM	GRIT	DISCS PER BOX	BOXES PER CASE	BOX PRICE	CASE PRICE
M139353	80 GRIT	100	10	\$0.37	\$0.32
M139354	100 GRIT	100	10	\$0.35	\$0.32
M139355	120 GRIT	100	10	\$0.35	\$0.32
M139356	150 GRIT	100	10	\$0.35	\$0.32
M139357	180 GRIT	100	10	\$0.35	\$0.32
M141468	220 GRIT	100	10	\$0.35	\$0.32

### 5" HOOK & LOOP X NO HOLE

ITEM	GRIT	DISCS PER BOX	BOXES PER CASE	BOX PRICE	CASE PRICE
M147011	80 GRIT	100	10	\$0.40	\$0.34
M145429	100 GRIT	100	10	\$0.38	\$0.34
M145430	120 GRIT	100	10	\$0.38	\$0.34
M142988	150 GRIT	100	10	\$0.38	\$0.34
M141245	180 GRIT	100	10	\$0.38	\$0.34
M141246	220 GRIT	100	10	\$0.38	\$0.34

PRICES ABOVE ARE LISTED PER DISC

## EKA400J (FORMERLY RKJO) DISCS

- PREMIUM ALUMINUM OXIDE GRAIN
- RESIN OVER RESIN BONDED
- VERY FLEXIBLE J-WT. CLOTH DISC
- LONG LIFE EDGE WEAR
- COMPARE TO: ANY CLOTH DISC MATERIAL



### 5" PSA STICKY DISCS X NO HOLE

ITEM	GRIT	DISCS PER BOX	BOXES PER CASE	BOX PRICE	CASE PRICE
M119569	80 GRIT	100	10	\$0.45	\$0.43
M119568	100 GRIT	100	10	\$0.43	\$0.41
M119567	120 GRIT	100	10	\$0.43	\$0.41
M119566	150 GRIT	100	10	\$0.43	\$0.41
M119565	180 GRIT	100	10	\$0.43	\$0.41
M119564	220 GRIT	100	10	\$0.43	\$0.41

PRICES ABOVE ARE LISTED PER DISC

## EKASILVER (FORMERLY RSBN)

- PREMIUM SILICON CARBIDE GRAIN
- RESIN OVER RESIN BONDED
- LIGHT "B" WEIGHT PAPER
- FOR LACQUER AND SEALER SANDING
- CAN BE USED WET BUT IS NOT WATERPROOF
- COMPARE TO: 3M 415U, 3M 415N



### 5" PSA STICKY DISCS X NO HOLE

ITEM	GRIT	DISCS PER BOX	BOXES PER CASE	BOX PRICE	CASE PRICE
M144873	120 GRIT	100	10	\$0.25	\$0.23
M143637	150 GRIT	100	10	\$0.25	\$0.23
M143636	180 GRIT	100	10	\$0.25	\$0.23
M144666	220 GRIT	100	10	\$0.25	\$0.23
M143638	320 GRIT	100	10	\$0.25	\$0.23

### 5" HOOK & LOOP NO HOLE

ITEM	GRIT	DISCS PER BOX	BOXES PER CASE	BOX PRICE	CASE PRICE
M144829	120 GRIT	100	10	\$0.26	\$0.24
M144182	150 GRIT	100	10	\$0.26	\$0.24
M144321	180 GRIT	100	10	\$0.26	\$0.24
M144718	220 GRIT	100	10	\$0.26	\$0.24
N144599	320 GRIT	100	10	\$0.26	\$0.24

PRICES ABOVE ARE LISTED PER DISC

## RKXO CLOTH WIDE BELTS

- RKXO
- PREMIUM ALUMINUM OXIDE GRAIN
- RESIN/RESIN BONDED TO A DURABLE X-WEIGHT POLYESTER CLOTH
- FOR SANDING ON SOFT AND HARD WOODS
- THIS MATERIAL IS WATERPROOF AND WASHABLE
- EXCELLENT CUTTING ABILITY AND LONG LIFE



ITEM	GRIT	TYPE	BELTS PER BOX	PRICE PER BELT
M138869	80 GRIT	36 X 75	5	\$59.00
M138870	100 GRIT	36 X 75	5	\$59.00
M138885	120 GRIT	36 X 75	5	\$59.00
M138871	150 GRIT	36 X 75	5	\$59.00
M138872	180 GRIT	36 X 75	5	\$59.00
M138859	220 GRIT	36 X 75	5	\$59.00
M137374	80 GRIT	37 X 60	5	\$40.73
M137817	100 GRIT	37 X 60	5	\$39.29
M139149	120 GRIT	37 X 60	5	\$39.29
M137408	150 GRIT	37 X 60	5	\$39.29
M140333	180 GRIT	37 X 60	5	\$39.29
M139509	220 GRIT	37 X 60	5	\$39.29
M137445	80 GRIT	37 X 75	5	\$48.41
M138379	100 GRIT	37 X 75	5	\$46.58
M138513	120 GRIT	37 X 75	5	\$46.58
M138514	150 GRIT	37 X 75	5	\$46.58
M140069	180 GRIT	37 X 75	5	\$46.58
M138430	220 GRIT	37 X 75	5	\$46.58

## PAPER WIDE BELTS

- ARKFO
- PREMIUM GRADE ALUMINUM OXIDE
- RESIN BONDED F-WEIGHT ANTISTATIC PAPER
- FOR SANDING ON SOFT AND HARD WOODS WHERE DUST FREE SURFACES ARE REQUIRED
- EXCELLENT CUTTING ABILITY AND LONG LIFE



ITEM	GRIT	TYPE	BELTS PER BOX	PRICE PER BELT
M106288	100 GRIT	36 X 75	5	\$36.54
M106289	120 GRIT	36 X 75	5	\$36.54
M106291	150 GRIT	36 X 75	5	\$36.54
M106294	180 GRIT	36 X 75	5	\$36.54
M106296	220 GRIT	36 X 75	5	\$36.54
M149115	100 GRIT	37 X 60	5	\$35.38
M106306	120 GRIT	37 X 60	5	\$35.38
M106307	150 GRIT	37 X 60	5	\$35.38
M106308	180 GRIT	37 X 60	5	\$35.38
M106309	220 GRIT	37 X 60	5	\$35.38
M106310	100 GRIT	37 X 75	5	\$41.77
M106312	120 GRIT	37 X 75	5	\$41.77
M106314	150 GRIT	37 X 75	5	\$41.77
M106316	180 GRIT	37 X 75	5	\$41.77
M106318	220 GRIT	37 X 75	5	\$41.77

## COMMON SIZE CLOTH NARROW BELTS

- RKXO
- PREMIUM ALUMINUM OXIDE GRAIN
- RESIN/RESIN BONDED TO A DURABLE X-WEIGHT POLYESTER/CLOTH
- FOR SANDING ON SOFT AND HARD WOODS
- THIS MATERIAL IS WATERPROOF AND WASHABLE
- EXCELLENT CUTTING ABILITY AND LONG LIFE



ITEM	GRIT	TYPE	BELTS PER BUNDLE	1+	20+
M138830	80 GRIT	6 X 80	10	\$12.05	\$11.22
M138831	100 GRIT	6 X 80	10	\$11.59	\$10.79
M138832	120 GRIT	6 X 80	10	\$11.59	\$10.79
M138833	150 GRIT	6 X 80	10	\$11.59	\$10.79
M138834	80 GRIT	6 X 89	10	\$12.50	\$11.65
M138835	100 GRIT	6 X 89	10	\$12.50	\$11.65
M138836	120 GRIT	6 X 89	10	\$12.50	\$11.65
M138837	150 GRIT	6 X 89	10	\$12.50	\$11.65
M138838	80 GRIT	6 X 108	5	\$15.07	\$14.03
M138839	100 GRIT	6 X 108	5	\$14.43	\$13.43
M138840	120 GRIT	6 X 108	5	\$14.43	\$13.43
M138841	150 GRIT	6 X 108	5	\$14.43	\$13.43
M138842	80 GRIT	6 X 196	5	\$23.33	\$21.79
M138843	100 GRIT	6 X 196	5	\$20.42	\$19.07
M138844	120 GRIT	6 X 196	5	\$20.42	\$19.07
M138845	150 GRIT	6 X 196	5	\$20.42	\$19.07

## CLEANER

**CLEANING BARS**  
P100241  
2 X 2 X 12



ITEM	1+
P100241	\$14.47

PLEASE CALL FOR INFORMATION ON OTHER SIZES, GRITS, AND MATERIALS



## ECONOMY CLOTH PORTABLE BELTS

- PREMIUM GRADE ALUMINUM OXIDE
- RESIN BONDED
- X - WEIGHT CLOTH BACKING



ITEM	GRIT	TYPE	BELTS PER BUNDLE	1+	20+
M107216	80 GRIT	3 X 21	10	\$1.09	\$1.01
M107218	100 GRIT	3 X 21	10	\$1.07	\$1.00
M107219	120 GRIT	3 X 21	10	\$1.07	\$1.00
M107221	150 GRIT	3 X 21	10	\$1.07	\$1.00
M107253	80 GRIT	3 X 24	10	\$1.18	\$1.09
M137371	100 GRIT	3 X 24	10	\$1.16	\$1.06
M107257	120 GRIT	3 X 24	10	\$1.16	\$1.06
M107258	150 GRIT	3 X 24	10	\$1.16	\$1.06
M107321	80 GRIT	4 X 24	10	\$2.00	\$1.83
M107323	100 GRIT	4 X 24	10	\$1.93	\$1.77
M107325	120 GRIT	4 X 24	10	\$1.93	\$1.77
M107326	150 GRIT	4 X 24	10	\$1.93	\$1.77
M107407	80 GRIT	6 X 48	10	\$4.13	\$3.81
M107411	100 GRIT	6 X 48	5	\$4.02	\$3.71
M107414	120 GRIT	6 X 48	5	\$4.02	\$3.71
M107416	150 GRIT	6 X 48	5	\$4.02	\$3.71

## PUMP SLEEVES



ITEM	GRIT	ACTUAL BELT SIZE	PUMP SLEEVE SIZE	BELTS PER BUNDLE	1+	10+
M103279	100 GRIT	6 X 7 15/32	2 X 6	10	\$1.95	\$1.83
M103280	120 GRIT	6 X 7 15/32	2 X 6	10	\$1.95	\$1.83
M103281	150 GRIT	6 X 7 15/32	2 X 6	10	\$1.95	\$1.83
M103282	180 GRIT	6 X 7 15/32	2 X 6	10	\$1.95	\$1.83
M130810	220 GRIT	6 X 7 15/32	2 X 6	10	\$1.95	\$1.83
M103301	100 GRIT	7 X 20	6 X 7	10	\$4.78	\$4.45
M103303	120 GRIT	7 X 20	6 X 7	10	\$4.78	\$4.45
M103304	150 GRIT	7 X 20	6 X 7	10	\$4.78	\$4.45
M130798	180 GRIT	7 X 20	6 X 7	10	\$4.78	\$4.45
M130799	220 GRIT	7 X 20	6 X 7	10	\$4.78	\$4.45
M135192	100 GRIT	8 X 20	6 X 8	10	\$5.93	\$5.52
M178076	120 GRIT	8 X 20	6 X 8	10	\$5.93	\$5.52
M132979	150 GRIT	8 X 20	6 X 8	10	\$5.93	\$5.52
M130480	180 GRIT	8 X 20	6 X 8	10	\$5.93	\$5.52
M141816	220 GRIT	8 X 20	6 X 8	10	\$5.93	\$5.52
M103527	100 GRIT	9 X 20	6 X 9	10	\$6.19	\$5.76
M103528	120 GRIT	9 X 20	6 X 9	10	\$6.19	\$5.76
M103531	150 GRIT	9 X 20	6 X 9	10	\$6.19	\$5.76
M103534	180 GRIT	9 X 20	6 X 9	10	\$6.19	\$5.76
M145880	220 GRIT	9 X 20	6 X 9	10	\$6.19	\$5.76
M132110	80 GRIT	8 X 18 1/4	5 X 8	10	\$5.70	\$5.13
M132109	150 GRIT	8 X 18 1/4	5 X 8	10	\$5.70	\$5.13

PLEASE CALL FOR INFORMATION ON OTHER SIZES, GRITS, AND MATERIALS

330-897-0017



Fax Order 330-897-0022

## UNEESPONGES

ITEM	GRIT	SIZE	SOLD IN	LESS THAN 1 CASE	QTY PER CASE	1-3 CASES	4-9 CASES	10+ CASES
P100732	FINE	3 3/4" X 4 3/4" X 1/2"	PIECES	\$0.88	250	\$0.63	\$0.54	\$0.48
P100728	SUPER FINE	3 3/4" X 4 3/4" X 1/2"	PIECES	\$0.88	250	\$0.63	\$0.54	\$0.48
P100715	MED/MED	2 3/4" X 3 3/4" X 1"	PIECES	\$0.88	250	\$0.63	\$0.54	\$0.48
P100714	FINE/FINE	2 3/4" X 3 3/4" X 1"	PIECES	\$0.88	250	\$0.63	\$0.54	\$0.48

### SILICON CARBIDE FLEXIBLE SPONGE

P100732  
P100728  
1/2" SPONGE

- FOR FINISH SANDING
- ABRASIVE MATERIAL COATED ON TWO SIDES

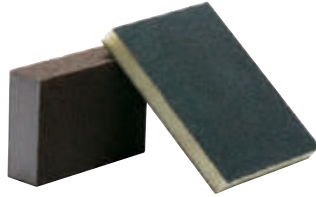

### ALUMINUM OXIDE SPONGE BLOCK

P100715  
P100714  
1" SPONGE

- FOR WHITE WOOD SANDING WHERE FLEXIBILITY IS NECESSARY
- ABRASIVE MATERIAL COATED ON FOUR SIDES

## WHITE SPONGES

- 1/2" UNEESPONGE
- WHITE ALUMINUM OXIDE FLEXIBLE SPONGE
- FOR FINISH SANDING
- ABRASIVE MATERIAL COATED ON TWO SIDES



ITEM	GRIT	SIZE	SOLD IN	LESS THAN 1 CASE	QTY PER CASE	1-3 CASES	4-9 CASES	10+ CASES
P102438	FINE	3 3/4" X 4 3/4" X 1/2"	PIECES	\$1.05	250	\$0.75	\$0.65	\$0.62
P102556	SUPER FINE	3 3/4" X 4 3/4" X 1/2"	PIECES	\$1.05	250	\$0.75	\$0.65	\$0.62

## EKASILK PLUS

- EKASILK PLUS SPONGES ARE WASHABLE AND REUSABLE.
- THE HOOK & LOOP SYSTEM IS SPECIFICALLY DESIGNED TO BE USED WITH EKASAND PNEUMATIC SANDING MACHINES.
- EKASILK PLUS SPONGES YEILD SUPERIOR LIFE COMPARED TO CONVENTIONAL SHEETS AND DISCS AND INCREASE SANDING EFFIECIENCY BY UP TO 50%.
- AND THANKS TO FOAM BACKING, THEY ADAPT TO ANY CONTOURS, CURVES, AND EDGES.



ITEM	Size	Grit	25+	100+	200+
P-104504	1/2" Sponge	3" x 4" Coarse	95¢	80¢	69¢
P-104505	1/2" Sponge	3" x 4" Medium	95¢	80¢	69¢
P-104506	1/2" Sponge	3" x 4" Fine	95¢	80¢	69¢
P-104507	1/2" Sponge	3" x 4" Very Fine	95¢	80¢	69¢
P-104508	1/2" Sponge	3" x 4" Superfine	95¢	80¢	69¢
P-104509	5mm Sponge	3" x 4" Coarse	95¢	80¢	69¢
P-104510	5mm Sponge	3" x 4" Medium	95¢	80¢	69¢
P-104511	5mm Sponge	3" x 4" Fine	95¢	80¢	69¢
P-104512	5mm Sponge	3" x 4" Very Fine	95¢	80¢	69¢
P-104513	5mm Sponge	3" x 4" Superfine	95¢	80¢	69¢
P-104528	5mm Sponge	5" x NH Medium	\$1.95	\$1.75	\$1.65
P-104529	5mm Sponge	5" x NH Fine	\$1.95	\$1.75	\$1.65
P-104530	5mm Sponge	5" x NH Very Fine	\$1.95	\$1.75	\$1.65
P-104531	5mm Sponge	5" x NH Superfine	\$1.95	\$1.75	\$1.65
P-104521	1/2" Sponge	5" x NH Fine	\$1.95	\$1.75	\$1.65
P-104522	1/2" Sponge	5" x NH Very Fine	\$1.95	\$1.75	\$1.65
P-104523	1/2" Sponge	5" x NH Superfine	\$1.95	\$1.75	\$1.65
P-104523	1/2" Sponge	5" x NH Superfine	\$1.95	\$1.75	\$1.65

## GRAPHITE

- GRAPHITE MUST BE ORDERED BY PART NUMBER AS WELL AS WIDTH AND LENGTH
- FELT ROLLS ARE ALSO AVAILABLE ON REQUEST
- ALL SIZES AND THICKNESSES AVAILABLE
- OTHER WIDTHS AVAILABLE PLEASE CALL FOR INFORMATION



ITEM	DESCRIPTION	PRICE PER METER
<b>M100487-2"</b>	HEAVY DUTY GRAPHITE _ 2" WIDTH	\$5.39
<b>M100487-2 1/2"</b>	HEAVY DUTY GRAPHITE _ 2 1/2" WIDTH	\$5.76
<b>M100487-3"</b>	HEAVY DUTY GRAPHITE _ 3" WIDTH	\$6.85
<b>M100487-4"</b>	HEAVY DUTY GRAPHITE _ 4" WIDTH	\$7.67
<b>M100487-6"</b>	HEAVY DUTY GRAPHITE _ 6" WIDTH	\$10.65
<b>M100487-8"</b>	HEAVY DUTY GRAPHITE _ 8" WIDTH	\$12.84
<b>M100487-9"</b>	HEAVY DUTY GRAPHITE _ 9" WIDTH	\$13.86

## EKASAND ORBITAL SANDER

- HIGHEST QUALITY AIR SANDER IN THE INDUSTRY
- 12,000-RPM SANDER AVAILABLE IN DIFFERENT MODELS
- MODEL E00015 (MOST POPULAR) IS A 5" X NO HOLE PSA
- VERY LIGHT WEIGHT METAL NON-VACUUM SANDER
- HOUSING WHICH GIVES EXCELLENT DURABILITY AND SUPERIOR PRODUCT LIFE
- MINIMAL VIBRATION WHICH HELPS REDUCE OPERATOR FATIGUE AND SWIRL MARKS
- EXTREMELY POWERFUL YET ONE OF THE QUIETEST SANDERS
- COMPARE TO: DYNA-BRADE, MASTER POWER, & SIOUX



**P-100659**  
**P-101757**



**P-101450**



**P-100687** **P-100688**  
3/16 ORBIT 3/32 ORBIT



ITEM	DESCRIPTION	PRICE
<b>P-100659</b>	5" VINYL FACE, 12,000 RPM, CENTRAL VACUUM SANDER	\$275.00
<b>P-100687</b>	5" VINYL FACE, 12,000 RPM, NON VACUUM SANDER 3/16" ORBIT	\$185.00
<b>P-100688</b>	5" VINYL FACE 12,000 RPM NON VACUUM SANDER 3/32" ORBIT	\$185.00
<b>P-100690</b>	5" HOOK & LOOP FACE, 12,000 RPM, NON VACUUM SANDER	\$185.00
<b>P-101450</b>	5" VINYL FACE, 12,000 RPM, SELF GENERATED VACUUM SANDER	\$285.00
<b>P-101757</b>	5" HOOK & LOOP FACE, 12,000 RPM, CENTRAL VACUUM SANDER	\$275.00
<b>P-101RM</b>	COMPLETE REPLACEMENT MUFFLERS	\$6.30

**PLEASE CALL FOR INFORMATION ON: OTHER SIZES, TYPES AND REPLACEMENT PARTS.**

**WE ARE A UNEEDA CERTIFIED REPAIR SHOP W/ 1-3 DAY TURN AROUND**  
**PLEASE CALL FOR INFORMATION ON OTHER SIZES, GRITS, AND MATERIALS**



## REPLACEMENT BACKING PADS FOR ORBITAL SANDERS

ITEM	GRIT	DESCRIPTION	1+	10+
P101452	MEDIUM - SOFT	5" DISC PAD TAPERED, REINFORCED WITH BLUE VINYL FACE	\$17.73	\$16.55
P101743	MEDIUM - SOFT	5" DISC PAD TAPERED, REINFORCED HOOK & LOOP PAD	\$17.73	\$16.55
P101419	FIRM	5" DISC PAD BULLNOSED, REINFORCED WITH BLUE VINYL FACE	\$14.44	\$13.47
P101498	FIRM	5" DISC PAD BULLNOSED, REINFORCED HOOK & LOOP PAD	\$17.73	\$16.55

PRICES ABOVE ARE LISTED PER PAD



## EKASAND RECTANGULAR SHEET SANDER

- RANDOM ORBITAL PNEUMATIC SANDER
- INCORPORATES A RANDOM 3/32 ORBIT AND RUNS AT 10,000 RPM'S
- REACHES CORNERS A DISC SANDER CAN NOT
- TWO SIZES: 3" X 4" AND 3 2/3" X 7"
- CAN BE CONFIGURED TO USE PSA OR HOOK & LOOP SHEETS
- M101814 AVAILABLE IN PSA, HOOK & LOOP, OR W/ CLIPS
- NON-VACUUM, CENTRAL VACUUM, AND SELF-GENERATED VACUUM MODELS
- EXTREMELY POWERFUL, ALMOST IMPOSSIBLE TO STALL
- LIGHTWEIGHT YET DURABLE
- VERY LOW NOISE AND VIBRATION



ITEM	DESCRIPTION	PRICE PER SANDER
M101721	E34010 _ 3" X 4" NON VACUUM PSA PAD SANDER	\$205.00
M101814	E37010 _ 3 2/3" X 7" NON VACUUM PSA PAD SANDER	\$220.00

## BACKING PADS FOR RECTANGULAR SANDERS



ITEM	DESCRIPTION	1+	10+
P105552	BACKUP PAD 3" X 4" HOOK FACE - SCREW ON, NON VAC	\$19.68	\$17.71
P105553	BACKUP PAD 3" X 4" HOOK FACE - SCREW ON, VAC	\$21.24	\$19.12
P102516	BACKUP PAD 3" X 4" VINYL FACE - SCREW ON, NON VAC	\$18.87	\$16398
P102518	BACKUP PAD 3" X 4" VINYL FACE - SCREW ON, VAC	\$20.39	\$18.35

PRICES ABOVE ARE LISTED PER PAD

PLEASE CALL FOR INFORMATION ON OTHER SIZES, GRITS, AND MATERIALS

## EKABLUE PSA ROLLS

- PREMIUM ALUMINUM OXIDE GRAIN
- RESIN OVER RESIN BONDED
- LIGHTER "B" WEIGHT LATEX PAPER
- FOR HAND SANDING OF ALL WOODS, LACQUER AND PAINTED SURFACES
- COMPARE TO: 3M GOLD , MIRKA GOLD, NORTON CHAMPAGNE AND CARBO RED
- SHEETS PERFORATED ON A ROLL



ITEM	GRIT	SIZE	SHEETS PER ROLL	BOX PRICE	ROLLS PER CASE	CASE PRICE
<b>M133907</b>	120 GRIT	3 2/3" X 7"	100	\$25.88	8	\$25.87
<b>M133908</b>	150 GRIT	3 2/3" X 7"	100	\$25.88	8	\$25.87
<b>M133909</b>	180 GRIT	3 2/3" X 7"	100	\$25.88	8	\$25.87
<b>M133912</b>	120 GRIT	3" X 4"	100	\$12.95	8	\$13.25
<b>M133913</b>	150 GRIT	3" X 4"	100	\$12.95	8	\$13.25
<b>M133914</b>	180 GRIT	3" X 4"	100	\$12.95	8	\$13.25
<b>M135662</b>	220 GRIT	3" X 4"	100	\$12.95	8	\$13.25
<b>M135663</b>	320 GRIT	3" X 4"	100	\$12.95	8	\$13.25

PRICES ABOVE ARE LISTED PER SHEET

## RSBNUU PSA ROLLS

- PREMIUM SILICON CARBIDE GRAIN
- RESIN OVER RESIN BONDED
- LIGHT "B" WEIGHT PAPER
- RECOMMENDED FOR LACQUER AND SEALER SANDING
- CAN BE USED WET BUT IS NOT WATERPROOF
- COMPARE TO: 3M 415U, 3M 415N
- SHEETS PERFORATED ON A ROLL

ITEM	GRIT	SIZE	SHEETS PER ROLL	BOX PRICE	ROLLS PER CASE	CASE PRICE
<b>M133910</b>	220 GRIT	3 2/3" X 7"	100	\$24.88	8	\$25.87
<b>M133911</b>	320 GRIT	3 2/3" X 7"	100	\$24.88	8	\$25.87
<b>M133915</b>	220 GRIT	3" X 4"	100	\$12.95	8	\$13.25
<b>M133916</b>	320 GRIT	3" X 4"	100	\$12.95	8	\$13.25

PRICES ABOVE ARE LISTED PER SHEET

## RSBN - RSBNUU REFILL ROLLS

- PREMIUM SILICON CARBIDE GRADE
- RESIN OVER RESIN
- LIGHT "B" WEIGHT PAPER
- FOR LACQUER AND SEALER SANDING
- CAN BE USED WET BUT IS NOT WATERPROOF
- PSA BACKING
- COMPARE TO: 3M 415U, 3M 415N
- FOR USE W/ 3M HAND TOOL 45203 (2 1/2") & 45204 (3 1/4")

ITEM	GRIT	SIZE	SHEETS PER ROLL	BOX PRICE	ROLLS PER CASE	CASE PRICE
<b>M-101643</b>	150 GRIT	2 1/2"	50	\$2.76	3	\$24.16
<b>M-101651</b>	180 GRIT	2 1/2"	50	\$2.76	3	\$24.16
<b>M-101652</b>	220 GRIT	2 1/2"	50	\$2.76	3	\$12.09
<b>M-101654</b>	320 GRIT	2 1/2"	50	\$2.76	3	\$12.09
<b>M-101646</b>	150 GRIT	3 1/4"	50	\$3.20	3	
<b>M-101655</b>	180 GRIT	3 1/4"	50	\$3.20	3	
<b>M-101648</b>	220 GRIT	3 1/4"	50	\$3.20	3	
<b>M-101649</b>	320 GRIT	3 1/4"	50	\$3.20	3	

PRICES ABOVE ARE LISTED PER SHEET

## FOAM ROLLS ACS PRO

- FOAM ROLL ACS PRO PADS ARE A NEW GENERATION OF ABRASIVES FOR HAND AND JITTERBUG SANDING. THEY ARE A UNIQUE, WATERPROOF, SPONGE BACKED ABRASIVE PRODUCT THAT ENABLES THE OPERATOR TO SAND WITH GREAT EFFICIENCY WHILE PROTECTING THE HAND FROM FRICTION GENERATED HEAT AND GENERAL SANDING STRESS. FOAM ROLL ACS PRO PADS ARE AVAILABLE IN ALUMINUM OXIDE FROM GRITS P120 THROUGH P400. THEY ARE PACKAGED IN CONVENIENT DISPENSER BOXES ON A ROLL OF 25 METERS OF PERFORATED 4 1/2" X 5" SHEETS. PERFORATED SHEETS TEAR CLEANLY AND EASILY FROM THE DISPENSER, WITH NO MATERIAL WASTE.



ITEM	DESCRIPTION	1 ROLL	4 ROLLS
<b>P-104395</b>	#120 5" PERF	\$63.78	\$59.53
<b>P-104396</b>	#150 5" PERF	\$63.78	\$59.53
<b>P-104397</b>	#180 5" PERF	\$63.78	\$59.53
<b>P-104398</b>	#220 5" PERF	\$63.78	\$59.53
<b>P-104399</b>	#240 5" PERF	\$63.78	\$59.53
<b>P-104400</b>	#280 5" PERF	\$63.78	\$59.53
<b>P-104401</b>	#320 5" PERF	\$63.78	\$59.53
<b>P-1044402</b>	#400 5" PERF	\$63.78	\$59.53

4 1/2 X 25 METERS PER ROLL  
PRICED PER ROLL

- RECOMMEND USES  
FOAM ROLL ACS PRO PADS CAN BE USED ON PAINT, WOOD, METAL, LEATHER AND PLASTICS. THEY ARE EXCELLENT FOR HAND SANDING ON WHITEWOOD AND SEALER SANDING. SUITABLE FOR SANDING CONTOURS WHERE FLEXIBILITY IS REQUIRED. FOAM ROLL ACS PRO PADS ARE IDEAL FOR THE AUTOMOTIVE INDUSTRY AND OTHER OVER THE COUNTER USES.

ITEM #	PAGE #
0251	100
10115	215
10255	213
10256	213
107	126
1091	114
1092-12	114
1092-128	114
1092-160	114
1092	114
1093	114
1094-12	114
1094-128	114
1094-160	114
1094	114
1097	118
1098	118
1099	118
110-3	140
110	140
110	214
11229	211
11287	39
11288	39
11289	39
11290	39
11291	39
11760	211
11760B	211
117	97
119	214
123-96	104
123	104
12362	211
12363	211
12364	211
1246	215
1249	215
125-96	104
125	104
1251	215
1253	215
1255	215
1257	215
1259	215
12613	215
12614	215
12615	215
12616	215
12617	215
12618	215
12619	215
12620	215
12621	215
12622	215
12623	215
12624	212
12625	212
12626	212

ITEM #	PAGE #
12627	212
12628	212
12696V5	211
12697V5	211
12702	211
127	98
1296ZN	155
13003	216
1300	40
1302	40
1307	40
1313	40
1314	40
13147	211
13152	211
1333	32
13360	215
1336	32
1337	32
1338	32
13465	214
13466	214
13467	214
13468	214
13469	214
13470	214
13579	216
13580	216
13581	213
13582	213
136	134
137	98
138.604.51.1515	170
138.622.50.0015	170
138.622.50.0815	170
1384	34
1387	34
14087	145
14303	41
144	215
1443	6
146	108
146	215
1466	13
147	215
148-322-54-0015	170
148-322-54-0815	170
148.304.54.1515	170
148.322.53.0015	170
148.322.53.0815	170
148.765.53.0015	170
148.765.53.0815	170
148.765.54.0015	170
148.765.54.0815	170
148	215
14935	211
149	6
15032	145
15065	145

ITEM #	PAGE #
152	108
152	8
154	135
156	134
1580	32
1581	32
1582	32
15827	145
1583	32
1584	27
1585	27
15853	145
15854	145
1586-2	27
1586	27
1587	27
1588	27
1589	27
1590	27
1592	27
1593	27
15968	145
16079	145
16080	145
16083	145
16084	145
16106	145
1623	214
165-12	104
165-128	104
165-160	104
165-96	104
165	104
1664	219
16829	145
16830	145
16831	145
16832	145
16833	145
16834	145
16835	145
16836	145
16837	145
16839	145
16840	145
173	7
174	135
174	7
176	134
176C	8
177-128	96
177-160	96
177-192	96
177-224	96
177-96	96
178	108
1784	27
1785	27
1786	27



ITEM #	PAGE #
1850GB	219
188-128	107
188-160	107
188-96	107
188	107
188L	107
18975-17	171
19001	21
19002	21
19003	21
19004	21
19005	21
19008	21
19009	11
19010	10
19011	10
19012	10
19013	10
19014	11
19015	11
19016	11
19017	11
19018	11
19019	11
1908	7
1910	6
19200	20
19201	20
19203	20
19205	20
19208	46
19257	18
19258	18
19259	20
193-128	126
193-160	126
193-3	126
193-4	126
193-96	126
19321	42
19322	42
19323	42
1950	13
1950H	13
19541	10
1971	46
1976	121
1977	121
1977S	121
202	140
204	135
206	134
218	109
21935	34
220	134
22094	34
22439	39
225-128	113
225-160	113

ITEM #	PAGE #
225-96	113
225	113
22855-10	176
22855-10SFT	176
22855-6-000N	176
22855-7-000N	176
22855-8-000N	176
22855-9	176
22855-9SFT	176
23010901	145
232	214
235	214
236	214
238	212
239-128	127
239-160	127
239-192	127
239-96	127
239	127
239	212
24001	20
24002	20
24003	42
24004	42
24005	42
24010	42
24011	42
24012	42
24013	21
24015	21
24016	21
24017	20
24018	20
24020	42
24021	42
242	108
253	7
254-3	132
254-96	132
259-128	110
259-160	110
259-192	110
259-96	110
259	110
26116	29
26117	29
26127	29
26130	29
26131	29
26	136
26137	29
26138	29
26139-2	29
26200	21
26201	17
26202	21
26203	17
26204	17
26205	17

ITEM #	PAGE #
26206	17
26207	17
264-128	92
264-160	92
264-192	92
264-3	92
264-96	92
26501	45
26502	45
26503	45
26504	45
26507	45
26511	45
26512	45
26513	45
26514	45
26517	45
26540	45
26541	45
26542	45
26543	45
26544	45
26545	45
26546	45
270	135
27016	16
27017	16
27018	16
272	134
2722	216
2724	216
274	108
286-128	110
286-160	110
286-192	110
286-224	110
286-96	110
29111	7
29112	6
29113	6
29115	6
29116	6
29120	7
29200	15
29201	15
29202	15
29203	15
29280	10
29289	10
29295	10
293-128	124
293-160	124
293-192	124
293-224	124
293-305	124
293-96	124
29303	10
29304	10
29305	10



ITEM #	PAGE #
29310	10
29340	14
29349	14
29355	14
29363	14
29364	14
29365	14
29366	14
29367	14
29368	14
29370	22
29379	22
29385	22
29393	22
29394	22
29395	22
29396	22
29397	22
29398	22
293T	124
29409	20
29415	20
29416	20
29423	20
29439	25
29445	25
29446	25
29460	9
2980	130
2981	130
302	135
303-200-14	176
303-200-14	176
303-200-18	176
303-200-20	176
303-200-22	176
304	134
308-128	127
308	213
309	213
310	213
3108	131
311	213
312	213
313	213
314-493-71-0015	171
314-493-71-0215	171
314-493-71-0415	171
314-493-71-0815	171
314	213
315	213
316	213
317-12	109
317-128	109
317-160	109
317-96	109
317	109
3171	94
317	213

ITEM #	PAGE #
3172	94
3173	94
3174	94
3175-TB	47
3175-TM	47
3180-TB	47
3180-TM	47
318	213
319	213
320	213
3208	131
3211	128
3308	131
331-128	127
331-96	127
331	127
331L	127
334	135
336	134
3390-2-000	175
3390-6-000	175
3390-716	175
3390-SC	175
3390	175
3391-000	175
3392-000	175
3393-000	175
3394-000	175
3401	6
3403	6
3404	46
3406	46
3413	6
3414	6
3415	7
3416	7
3423	6
3424	8
3425	8
3428	47
3429	46
343-12	103
343-128	103
343-160	103
343-96	103
343	103
3433	6
3441	7
346-290-90-0215	171
346-290-91-0015	171
346-290-91-0215	171
346-290-91-0415	171
351-128	127
351-96	127
351	127
351L	127
36546	43
36547	43
36548	43

ITEM #	PAGE #
36549	43
36550	43
36556	19
36557	19
36558	19
36559	19
36560	19
36561	19
36568	30
36569	30
36570	30
36571	30
36572	30
36573	18
36574	18
36575	18
36580	14
36582	14
36584	14
36585	14
36593	16
36594	16
36595	16
36601	17
36602	17
36603	32
36604	32
36605	17
36606	17
36607	17
36608	32
36609	32
36613	16
366	135
36614	37
36615	37
36616	16
36617	37
36621	37
36622	37
36623	37
36628	25
36629	25
36640	10
36642	38
36643	38
36644	38
36645	38
36647	15
36648	15
36649	15
36650	15
36651	24
36652	24
36653	24
36654	24
36655	24
36656	24
36720	32





ITEM #	PAGE #
36724	32
36725	32
36726	32
36735	38
36736	38
36737	38
36743	9
36744	9
36745	9
36746	9
36750	22
36751	22
36752	22
36753	22
36758	9
36759	9
36760	9
36761	9
36762	9
36763	9
36765	44
36766	44
36767	44
36768	44
36769	44
36774	43
36775	43
36776	43
36777	43
36780	23
36781	23
36782	23
36782	23
36793	34
36794	34
36795	34
36796	34
368	134
36836	39
36837	39
36838	39
36839	39
36840	39
36843	33
36844	33
36845	33
36846	33
36852	36
36853	36
36854	36
36857	18
36857	30
36857	30
36858	18
36858	30
36859	18
36859	30
36860	18
36860	30

ITEM #	PAGE #
36861	18
36861	30
36864	33
36865	33
36866	33
36867	33
36868	33
36869	33
36872	13
36873	13
36874	13
36875	13
36876	13
36877	13
36880	21
36881	21
36882	21
36883	21
36884	21
36893	40
36894	40
36895	40
36896	40
36899	36
36900	36
36904	42
36907	19
36909	30
36912	42
36912	42
36913	42
36914	42
36917	41
36918	41
36919	41
36920	41
370	108
382-128	129
382-160	129
382-96	129
382	129
3898	140
3899	140
3910	133
39	135
3915	137
3940	131
3950	131
3960	131
3970	131
3970	132
397	135
3980	102
3990	95
3991	111
399	134
400.OP71.05	174
400.OP72.05	174
400.OP73.05	174

ITEM #	PAGE #
400.OP74.05	174
400.OR22.05	174
400.OR23.05	174
400.OR24.05	174
400.OR25.05	174
400.3453.65	174
400.3454.65	174
400.3455.65	174
400.3457.65	174
400.3458.65	174
400	136
40	134
40515	11
40516	11
40517	11
40518	11
40519	11
406-128	127
4080	216
4081	216
4082	216
4084	216
4085	216
411689	128
412461	128
4128	119
415-12	111
415-128	111
415-160	111
415-96	111
415-96V	111
415	111
415S	111
4160	119
417	109
417572	128
4192	119
423-3	129
423-96	129
423	129
4235	38
424	129
4288	119
431	119
431	119
432-BF-3C	187
432-BF-6C	187
432-BF-9C	187
435-128	93
435-160	93
435-96	93
435	93
435L	93
436-128	93
436-96	93
4424	24
4425	24
4426	24
4427	24



ITEM #	PAGE #
4428	24
4429	24
4476	6
4478	7
4479	7
448-BC-5C	187
448-BC-8C	187
449-3	132
449-96	132
449	132
457-96	119
457	119
457L	119
464ZN	155
4656	128
4688	213
4690	128
47061101	144
47070702	144
47070710	144
47074524	144
47091702	144
47097502	144
47120717	144
47120762	144
4722	214
475	136
48	108
484-128160	103
484-192224	103
484-305	103
484-32	103
484-396	103
484	103
4903-10-ZP	178
4903-12-ZP	178
4903-14-ZP	178
4903-16-ZP	178
4903-18-ZP	178
4903-20-ZP	178
4903-22-ZP	178
4903-24-ZP	178
4903-26-ZP	178
4903-28-ZP	178
4903-BRKT	178
494	135
496	134
4SR-18	186
4SR-21	186
4WCT-1	186
4WCT-3	186
4WLS072-28-52	186
4WLS072-32-52	186
4WLS073-18-52	186
4WLS073-20-52	186
4WLS472-28-52	186
4WLS472-32-52	186
4WLS882-32-570	186
4WLS882-35-570	186

ITEM #	PAGE #
500.0161.05	174
500.0179.05	174
500.0181.05	174
500.0280.05	174
500.0535.05	174
500.0536.05	174
500.0537.05	174
500.0M73.05	173
500.OU22.05	173
5128	107
516	126
5173	215
519-12	101
519-128	101
519-160	101
519-18	101
519-96	101
519	101
5192	107
5213	213
5215	216
5224	107
525-96	131
525	131
525	132
5260	18
5261	18
527-128	97
527-12	97
527-160	97
527	97
5285	212
5286	212
52994	7
52995	7
52996	7
53000	6
53001	6
53002	6
53003	41
53004	6
53005	19
53006	7
53007	8
53008	8
53009	8
53010	16
530	108
53011	6
53012	34
530142	128
530143	128
53014	41
530144	128
53015	6
53016	6
53018	6
53019	16
53021	6

ITEM #	PAGE #
53022	6
53029	31
53030	31
53031	31
53032	31
53033	31
53035	23
53036	23
53037	23
5319	107
53470	6
53471	6
535-128	92
535-160	92
535-96	92
53529	31
53530	31
53531	31
53532	31
53533	31
535342	31
535	92
535L	92
536-128	92
536-96	92
537-128	98
537-12	98
537-160	98
53700	28
53701	28
53702	28
53704	16
53705	16
53710	37
53711	37
53712	37
53713	37
53714	37
53715	37
53716	37
53717	44
53718	44
53719	44
53720	44
53721	44
53722	44
537	98
53801	28
53802	28
53803	28
53804	28
53805	28
53806	28
53807-2	28
54008	11
54021	37
54022	37
54023	44
54024	44



ITEM #	PAGE #
54025	11
5447	215
5480	107
549-128	113
549-160	113
549-192	113
549-320	113
549-96	113
55220	12
55221-2	12
55222	12
55223	12
55224	12
55225	12
55226	12
55227	12
55266	41
55268	41
55270	12
55271	12
55272	12
55273	12
55274	12
55275	12
55276	12
55277	12
55278	12
55279	12
55280	12
55311	26
55312	26
55315	26
55316	26
55317	26
55318	26
55319	26
55321	26
55322	26
55323	26
55324	26
55340	35
55341	35
55342	35
55343	35
55344	35
55346	35
55347	35
55348	35
55349	35
55350	35
55360	36
55364	36
55365	36
55367	36
55368	36
55369	36
55370	36
55371	36
558	135

ITEM #	PAGE #
560	134
563-32	188
563-32 C	188
563-47	188
563-47 C	188
563-51 C	188
565-10-52	186
565-14-52	186
5673	107
56990383-49	145
575-96	139
575	139
580ZN	155
585-12	102
585-128	102
585-160	102
585-96	102
585	102
585L	102
5900	107
594	6
595-128	98
595-96	98
595	119
595	98
596	107
600.0P29.05	173
600.0R23.05	173
600.0R25.05	173
600.3458.65	173
600.3553.65	173
600.3554.65	173
600.3555.65	173
600	136
6012-18-11-52	185
6012-18-15-52	185
6012-20-11-52	185
6012-20-15-52	185
6012-28-11-52	185
6012-28-15-52	185
6013-18-11-526	185
6013-18-15-526	185
6013-20-11-526	185
6013-20-15-526	185
602-12	121
602-128	121
602-96	121
602	121
602S	121
6055	214
6056	214
6057	214
6063	214
6072-18-11-52	185
6072-18-15-52	185
6072-20-11-52	185
6072-20-15-52	185
6072-28-11-52	185
6072-28-15-52	185

ITEM #	PAGE #
6072-32-11-52	185
6072-32-15-52	185
613-128	92
613-160	92
613-96	92
613	92
613L	92
618	105
618L	105
622	135
624	134
625-128	138
625-160	138
625-192	138
625-224	138
625-3	138
625-320	138
625-448	138
625-96	138
635-128	120
635-160	120
635-256	120
635-32	120
635-96	120
647-3	140
647-96	140
647	140
6472-18-11-52	185
6472-18-15-52	185
6472-24-11-52	185
6472-24-15-52	185
6472-28-11-52	185
6472-28-15-52	185
6472-32-11-52	185
6472-32-15-52	185
650-12	106
650-128	106
650-160	106
650-96	106
650	106
6552-0220-4	186
6552-ETH-10	186
658-12	122
658-128	122
658-160	122
658-192	122
658-224	122
658-96	122
6581-11-11-4	186
6581-11-15-4	186
6581-14-11-4	186
6581-14-15-4	186
6581-14-5	186
6581-25-5	186
6581-28-5	186
6581-31-5	186
658	122
667-12	117
667-128	117



ITEM #	PAGE #
667-160	117
667-18	117
667-224	117
667-305	117
667-3	117
667-96	117
667	117
667L	117
667S	117
6802	214
6882	215
69151	6
69153	7
700.0179.25	173
700.0181.25	173
700.0280.25	173
700.0535.25	173
700.0536.25	173
700.0537.25	173
700.0M73.05	173
70139-10	170
7128	47
7139	46
718-128	105
718	105
719	135
720	134
722	108
7304	212
7306	212
7307	212
7308	212
7309	212
7310	212
7311	212
7312	212
735	8
737-128	99
737-12	99
737-160	99
737-96	99
7379	214
7380	214
7390-2-000	175
7390-6-000	175
7390-716	175
7390	175
7391-000	175
7392-000	175
7393-000	175
7394-000	175
745-128	127
74554	85
749-128	123
749-128B	123
749-160	123
749-224	123
749-96B	123
749	123

ITEM #	PAGE #
752-128	120
752-160	120
752-19	120
752-192	120
752-224	120
752-96	120
7550	47
7565	47
7566	47
761	135
76247	46
76273	8
76312	13
76313	13
763	134
766	8
771-128	138
771-160	138
771-3	138
771-96	138
771	15
772	15
776-128	127
776	8
778	8
7891	215
7892	214
7927	212
7935	212
7936	212
7937	212
798-128	119
798-160	119
798-96	119
8000-BRKT	178
8004	137
80152-128	115
80152-160	115
80152-96	115
80176-AE	61
80177-AE	61
80223-AE	61
80644-AE	61
8080	214
8081	215
80814	137
80815	137
8082	215
8083	215
8084	215
8085	215
80859-AE	61
8086	215
81021	115
81065	137
818-128	95
818-12	95
818-160	95
818-96	95

ITEM #	PAGE #
818	95
818L	95
8233	111
8236	95
8237	109
839-128	99
839-160	99
839-3	99
839-96	99
847-128	118
847-160	118
847-96	118
8500-12-SOFT	178
8500-15-SOFT	178
8500-18-SOFT	178
8500-21-SOFT	178
853	40
854	40
865	13
867-128	93
867-160	93
867-228	93
867-320	93
867-3	93
867-96	93
867	13
867	93
867L	93
874-128	96
874-160	96
874-96	96
874	40
874	96
885-128	106
885-160	106
885-192	106
885-224	106
885-305	106
885-96	106
885	106
885L	106
888	8
897-3	136
897	136
897L	136
9014	214
9015	214
9016	214
9017	214
9018	214
9040	219
910-12	115
910-128	115
910-160	115
910-96	115
910	115
910S	115
915	99
918-12	116



ITEM #	PAGE #
918-128	116
918-160	116
918-96	116
918	116
918L	116
924.200.40.0115	171
925-96	104
925	104
9337	40
9338	40
9339	40
935-12	116
935-128	116
935-160	116
935-96	116
935	116
9362	17
9365	16
937-3	132
937-96	132
9440	213
9441	213
950	108
959-96	95
959	95
972-12	112
972-128	112
972-160	112
972-224	112
972-305	112
972-96	112
972	112
972L	112
972S	112
976-128	127
9765	46
9765F	46
9770	214
9773	46
984-128	137
984-160	137
984-192	137
984-3	137
984-96	137
988-128	140
988-160	140
988-3	140
988-96	140
988	140
993-128	126
993-3	126
993-96	126
993	126
A271-3.5AL	139
A271-3AL	139
A271-4AL	139
A271-96AL	139
A299	153
A300	153

ITEM #	PAGE #
A301	153
A307	153
A308	153
A309	153
A310	153
A311	153
A313	147
A313	153
A313	211
A314	153
A38-3	153
A38-6	153
A38TN	153
A500-10	130
A500-12	130
A500-125	130
A500-3	130
A500-4	130
A500-6	130
A500-8	130
A610	153
A76209-AE	62
AFB-1	161
AFB-2	161
AFB-3	161
AFBL-4	78
AFBR-2	78
AFGR-1	78
AFRD-3	78
AIR MODEL	219
ARB-5	161
B-10-4	155
B15-4	154
B15-6	154
B18-4	154
B19-4	154
B20-4	155
B21-4	155
B22-4	155
B812-96R	118
BBH10	154
BBW12	71
BBW15	71
BBW1	71
BBW2-A	71
BBW2	71
BBW4	71
BBW5-A	71
BBW5	71
BBW8	71
BBW9-A	71
BBW9	71
BC12	212
BF100-C	204
BF100-M	204
BF100-O	204
BF42-C	204
BF42-M	204
BF42-O	204

ITEM #	PAGE #
BF42-P	204
BF44-C	204
BF44-M	204
BF44-O	204
BF52-A	204
BF52-C	204
BF52-M	204
BF52-O	204
BG1-PB	73
BG2-PBL	73
BG3-PB	73
BG4-SN	73
BG5-BL	73
BG6-SN	73
BG7-O	73
BG8-M	73
BG9-BL	73
BH14-DAB	77
BH15-DAB	77
BH15A-DAB	77
BH16-A	77
BH16-BL	77
BIT11	211
BIT1	211
BIT135	211
BIT145	211
BIT2	211
BIT235	211
BIT245	211
BIT265	211
BIT6	211
BLSK224-SET	180
BLSK228-SET	180
BLSK232-SET	180
BLSR218-SET	180
BLSR220-SET	180
BLSR224-SET	180
BLSR228-SET	180
BLSR2318-SET	180
BLSR2320-SET	180
BN18012G	220
BN18034G	220
BN18058G	220
BN18078G	220
BN18100G	220
BN18112G	220
BN18114G	220
BN18118G	220
BN181316G	220
BN18134G	220
BN18138G	220
BN181916G	220
BN18200G	220
BSB-6	154
BSB-7	155
C15-C	204
C15-M	204
C15-O	204
C203-C	199



ITEM #	PAGE #
C203-O	199
C207-C	199
C207-O	199
C209-O	199
C21-C	204
C21-M	204
C21-O	204
C211-C	199
C211-O	199
C212-C	199
C212-O	199
C215-C	199
C215-O	199
C218-C	199
C218-O	199
C225-O	199
C29-C	204
C29-M	204
C29-O	204
C6012L	149
C6012R	149
C6014	149
C608-C	199
C608-O	199
CAN-35	181
CAN-35LID	181
CAN-35LIDG	181
CAN-35LIDW	181
CAN-35W	181
CAN-50	181
CAN-50LID	181
CAN-50LIDG	181
CAN-50LIDW	181
CAN-50W	181
CAN-DOORKIT	181
CAN-DOORKITW	181
CAN-EBMD50B-R	181
CAN-EBMD50W-R	181
CAN-EBMDB-R	181
CAN-EBMDW-R	181
CAN-EBMSB-R	181
CAN-EBMSW-R	181
CB14100	211
CB14110	211
CB1430	211
CB1435	211
CB1440	211
CB1445	211
CB1445LP-BL	147
CB1450	211
CB1460	211
CB1470	211
CB1480	211
CB1485	211
CB1490	211
CBRH-1	189
CF15-C	204
CF15-M	204
CF15-O	204

ITEM #	PAGE #
CF21-C	204
CF21-M	204
CF21-O	204
CF29-C	204
CF29-M	204
CF29-O	204
CGS1067-3D	178
CGS1068-1D	178
CGS1069-RM	178
CGS1070-21	178
CGS1071-18	178
CGS1072-15	178
CGS1073-12	178
CGS	200
CH-KIT	150
CH5-BR	149
CH6-BP	149
CL1120	196
CL2	196
CL3	196
CL351	195
CL35	195
CL351A	195
CL351B	195
CL352	195
CL352A	195
CL352B	195
CL353	195
CL353A	195
CL353B	195
CL35A	195
CL35B	195
CL361	195
CL36	195
CL362	195
CL363	195
CL4	196
CL6	196
CL8	196
CL9-LED	197
CL9	197
CLB348	195
CLB40N	195
CORDLESS	219
CORDLESS FUEL CAR-TRIDGE	219
CRS	200
CT-1*-52	188
CT-2*-52	188
CT-3*-52	188
CT-4*-52	188
CTLB1	157
CTLB2	157
D1618-AB	72
D1618-AC	72
D1618-ORB	72
D1618-PB	72
D1618-PN	72
D2753-SN	59
D521-BL	64

ITEM #	PAGE #
D521-SN	64
D521-W	64
D522-BL	65
D523-BL	64
D523-SN	64
D523-W	64
D524-BI	65
D525-AE	65
D525-BL	65
D525	65
D526-AE	65
D526-BL	65
D526	65
D527-A	64
D527-AE	64
D527-B	64
D528-A	64
D528-AE	64
D528-B	64
D529-A	64
D529-AE	64
D529-B	64
D542-AC	65
D550-A	65
D550-B	65
D550	65
D551-B	65
D551	65
D552-AC	63
D552-BL	63
D552-ORB	63
D553-AC	63
D553-BL	63
D553-ORB	63
D560-AP	65
D561-AP	65
D89-AE	62
D89-BL	62
D924-AC	63
D924-AE	63
D924-BL	63
D925-AC	63
D925-AE	63
D925-BL	63
D942-AC	63
D942-AE	63
D942-BL	63
DB210	205
DF1	162
DKB-18	179
DKDB-BIT	205
DLS10	158
DLS12	158
DLS6	158
DLS8	158
DRILL TEMP	164
DRS-12	177
DRS-14	177
DRS-16	177

ITEM #	PAGE #
DRS-18	177
DRS-20	177
DRS-22	177
DRS1	177
DYNA-12-2D	164
DYNA-15-2D	164
DYNA-15-3D	164
DYNA-18-2D	164
DYNA-18-3D	164
DYNA-21-2D	164
DYNA-21-3D	164
DYNA-9-2D	164
DYNA-9-BRKT	164
DYNA-DEPTH ADJ	164
DYNA-PUSH OPEN	164
DYNA-SYNC ROD	164
DYNA3D-LH ADAPT	164
DYNA3D-RH ADAPT	164
DYNAFLD-1D-LH	164
DYNAFLD-1D-RH	164
DYNAFLD-2D-LH	164
DYNAFLD-2D-RH	164
DYNAFLD-3D-LH	164
DYNAFLD-3D-RH	164
DYNAFLD-LH-NAR	164
DYNAFLD-RH-NAR	164
DYNAHD-18-3D	164
DYNAHD-21-3D	164
DYNAHD-24-3D	164
DYNAHD-27-3D	164
DYNAHD-30-3D	164
E1-AE	73
E1-PB	73
E3-AE	73
E3-PB	73
E80	73
E81	73
EB1	160
EB2	160
EDS-BR	161
EDS-WH	161
EE16-AE	150
EE16-BL	150
EE16-PB	150
F017139414228	167
F017139415228	167
F017139416228	167
F017139417228	167
F028138519228	167
F028138520228	167
F028138521228	167
F028138522228	167
F028138523228	167
F028138524228	167
F028138525228	167
F028138526228	167
F028138561217	168
F028138562217	168
F028138563217	168

ITEM #	PAGE #
F028138564217	168
F028138565217	168
F028138566217	168
F034139385228	167
F034139386228	167
F034139387228	167
F034139388228	167
F035139443228	167
F035139444228	167
F045138457228	167
F045138458228	167
F045138459228	167
F045138460228	167
F045138461228	167
F045138462228	167
F045138463228	167
F045138464228	167
F045138499217	168
F045138500217	168
F045138501217	168
F045138502217	168
F045138503217	168
F045138504217	168
F045138517228	168
F053139671223	169
F053139677223	169
F058139746228	168
F058139747228	168
F058139748228	168
F058139749228	168
F058139825228	168
F058139826228	168
F058139827228	168
F058139828228	168
F058139831228	168
F058139888217	168
F058139892217	168
F058139893217	168
F058139894217	168
F058139895217	168
F105-07	89
F106-07	89
F110-07	89
F117-07	89
F1401	73
F1403	73
F150000014223	171
F150145125223	171
F229-9	179
F305-12	179
F381-15	179
F457-18	179
F533-21	179
F600-24	179
FC-6112	216
FC-6114	216
FF-6112	216
FF-6114	216
FF6-BL	73

ITEM #	PAGE #
FF6-SN	73
FF6112HL	216
FF6114HL	216
FF6	73
FFC12-11	150
FGP-C	201
FGP-M	201
FGP-O	201
FGP-W	201
FH-2 X 3/8	148
FM-110	206
FM64	207
FM65	207
FM68	207
FM69	207
FN16034G	220
FN16058G	220
FN16078G	220
FN16100G	220
FN16112G	220
FN16114G	220
FN16118G	220
FN16134G	220
FN16200G	220
FN16214G	220
FP1/2-C	201
FP1/2-O	201
FP3/8-C	201
FP3/8-H	201
FP3/8-M	201
FP3/8-O	201
FW1	211
FW2	211
FW3	211
G110	105
G110L	105
G120	105
G120L	105
G130	105
G130L	105
G140	105
G140L	105
G150	105
G150L	105
GC1850	219
GFC01-04	219
GL329	154
GL523	154
GLBOT-1	209
GLBOT-2	209
GLTIP1	209
GLTIP2	209
GPF 1/4" X 1 1/2"	198
GPF 1/4" X 2"	198
GPF 3/8" X 1 1/2"	198
GPF 3/8" X 1 1/4"	198
GPF 3/8" X 1 3/4"	198
GPF 3/8" X 2"	198
GRF1	161



ITEM #	PAGE #
GRF2	161
GRF3	161
H076014	85
H076015	85
H076016	85
H076017	85
H076018	85
H076019	85
H076020	85
H076021	85
H076127	80
H076128	80
H076129	80
H076130	80
H076131	80
H076132	80
H076133	80
H076134	80
H076135	80
H076698	83
H076699	83
H076700	83
H076701	83
H076702	83
H076703	83
H076704	83
H076705	83
H076706	83
H110	77
HA200	184
HA225	184
HB142	211
HB143	211
HB144	211
HB145	211
HB146	211
HB147	211
HB148	211
HC12	156
HC13	156
HD5	210
HDSB-66	159
HDSB-68	159
HDSB-810	159
HH-10-BL	177
HH-10-Z	177
HH-12-BL	177
HH-12-Z	177
HH-14-BL	177
HH-14-Z	177
HH-16-BL	177
HH-16-Z	177
HH-18-BL	177
HH-18-Z	177
HH-20-BL	177
HH-20-Z	177
HH-22-BL	177
HH-22-Z	177
HH-24-BL	177

ITEM #	PAGE #
HH-24-Z	177
HH-26-Z	177
HH-28-Z	177
HH075010	81
HH075028	81
HH075326	82
HH075327	82
HH075328	82
HH075329	82
HH075336	82
HH075337	82
HH075341	82
HH075422	82
HH076011	81
HH076012	81
HH076013	81
HH2	177
HH3	177
HH4424-BL	64
HH4425-BL	64
HMB3/8-O	201
HMS175	183
HMS190	183
HMS200	183
HMS250	183
HMS260L	183
HN1	211
HN2	211
I300	124
I350-128	124
I350-160	124
I350	124
INSET-13901	164
JB0	201
JB10	201
JB20	201
JCN-14	211
JCN-14K	211
JG416	156
JGW1	156
K089-W	66
K1000	58
K1001	58
K1002	58
K1003	58
K1004	58
K1005	58
K1006	58
K1007	58
K1008	58
K1009	58
K1010	58
K105-AE	62
K107-AEM	54
K107-ASM	54
K107-DBAC	54
K107-SN	54
K114-M	70
K114-O	70

ITEM #	PAGE #
K114-W	70
K117-ABMD	53
K117-DACM	53
K117-DBAC	53
K117-SIM	53
K1216-SN	59
K1300-DACM	66
K1300-SIM	66
K1350-DACM	66
K1350-SIM	66
K1461-AE	61
K1461-PB	61
K1462-AE	61
K1462-PB	61
K1463-AE	61
K1463-PB	61
K1464-AE	61
K1464-PB	61
K147-AE	62
K150-LP	60
K152-AE	60
K155-96ABSB	56
K155-96DBAC	56
K155-96DBN	56
K155-96SN	56
K155-ABSB	56
K155-DBAC	56
K155-DBN	56
K155-SN	56
K156-AE	62
K15	67
K157-AE	62
K1814-W	66
K1884	67
K1908	67
K195-ACM	56
K195-DBAC	56
K196-ACM	56
K196-DBAC	56
K200-LP	60
K2017-BL	59
K2017-SN	59
K2020	162
K2029-ABMD	52
K2029-BL	52
K2029-LAP	52
K2029-OB	52
K2029-SN	52
K204-LP	60
K2040-BL	52
K2040-OB	52
K2040-SN	52
K205-LP	60
K208-AE	62
K2302-AS	52
K2335-OB	52
K2335-WN	52
K235	68
K26-SN	59



ITEM #	PAGE #
K260-DBAC	55
K260-DBN	55
K271-3.5-SS	139
K271-3SS	139
K271-4SS	139
K271-96-SS	139
K272-BL	59
K272-SN	59
K282-AN	53
K2910-SN	68
K2980-AB	57
K2980-DACM	57
K2980-DBAC	57
K2980-ORB	57
K2980-SN	57
K2981-AB	57
K2981-DACM	57
K2981-DBAC	57
K2981-ORB	57
K2981-SN	57
K3031-DACM	67
K3062-ORB	55
K3062-SI	55
K3062-SN	55
K3063-ORB	55
K3063-SI	55
K3063-SN	55
K3108-DBAC	54
K3108-SN	54
K317-96ABSB	62
K317-96DBAC	62
K317-96DBN	62
K3208-AE	62
K3208-DBAC	54
K3208-SN	54
K321-LP	67
K3211-PB	68
K3211-SN	68
K3217-DACM	52
K3219-96-BRN	50
K3219-96-BYAB	50
K3219-96-ORB	50
K3219-BRN	50
K3219-BYAB	50
K3219-ORB	50
K3222-W	66
K3235-128-BL	50
K3235-128-BRN	50
K3235-128-BYAB	50
K3235-128-ORB	50
K3235-96-BL	50
K3235-96-BRN	50
K3235-96-BYAB	50
K3235-96-ORB	50
K3248-W	66
K326-LP	67
K3272-DACM	67
K3273-DACM	67
K329-LP	67

ITEM #	PAGE #
K330-AN	53
K3417-BB	51
K3417-GOLD	51
K3417-ORB	51
K3417-WN	51
K3489-MB	59
K3489-SN	59
K38	67
K3898-DBAC	54
K3898-DBN	54
K3899-DBAC	54
K3899-DBN	54
K39	67
K40-A	70
K40-B	70
K40-C	70
K400-SN	59
K41-A	70
K41-B	70
K41-C	70
K4118-BB	51
K4118-ORB	51
K4118-WN	51
K417-ABSB	62
K417-DBAC	62
K417-DBN	62
K4	205
K4218-BB	52
K4218-ORB	52
K4218-WN	52
K426-SN	59
K4275	70
K4277	70
K4278	70
K4318-AE	52
K4318-BN	52
K4318-BRPW	52
K4318-ORB	52
K4375	70
K4377	70
K4378	70
K44-B	70
K4418-BN	52
K4438-WI	52
K45-A	70
K45-B	70
K45-C	70
K46-A	70
K46-B	70
K46-C	70
K4618-BN	51
K4618-HB	51
K4618-SAB	51
K462-BL	66
K462-SIM	66
K4655-AB	59
K4655-BLK	59
K4655-SN	59
K4690-SN	59

ITEM #	PAGE #
K47-A	70
K47-B	70
K47-C	70
K475-SN	59
K48-B	70
K49-B	69
K49-BC	69
K49-D	69
K49-H	69
K50-B	69
K50-C	69
K51-B	69
K51-C	69
K515-SN	59
K516-AEM	54
K516-ASM	54
K516-DBAC	54
K516-SN	54
K517-ABSB	62
K517-DBAC	62
K517-DBN	62
K519-96ABSB	56
K519-96DBAC	56
K519-96DBN	56
K519-ABSB	56
K519-DBAC	56
K519-DBN	56
K52-B	69
K525-96DBAC	60
K525-96DMAC	60
K525-96SN	60
K525-DBAC	60
K525-DMAC	60
K525-SN	60
K527-ABMD	53
K527-DACM	53
K527-DBAC	53
K527-SIM	53
K53-BL	69
K530-W	66
K5302-AB-O	68
K5302-AB	68
K5302-PB-O	68
K5302-PB	68
K5312-AB-O	68
K5312-AB	68
K5312-PB-O	68
K5312-PB	68
K5319-SN	59
K54-B	69
K54-C	69
K55-B	70
K55-C	70
K558-BL	66
K558-SI	66
K56-B	70
K56-C	70
K57-B	70
K570-W	66



ITEM #	PAGE #
K58-BL	66
K58-SI	66
K6060-DBAC	55
K6060-DBN	55
K6102-ORB	54
K6102-SN	54
K6303-ABMD	53
K6303-DACM	53
K6303-DMAC	53
K6303-MB	53
K6303-RG	53
K6303-SIM	53
K6373-ABMD	53
K6373-DACM	53
K6373-DBAC	53
K6373-DMAC	53
K6373-MB	53
K6373-RG	53
K6373-SIM	53
K6373-SN	53
K6464-DBAC	55
K6464-SN	55
K6465-DBAC	55
K6465-SN	55
K6640	67
K6641-A	67
K6641-SN	67
K6641	67
K6765-ORB	54
K6765-SN	54
K70-A	69
K703-AE	62
K706-AE	60
K70	69
K707-AE	60
K763-AE	62
K773-HB	51
K773-SAB	51
K773-SN	51
K790-SN	59
K800-SN	57
K8005	66
K8006	66
K801-B	57
K8018-LP	67
K802-AE	57
K8026-SN	59
K803-BI	57
K804-B	57
K805-SN	57
K806-AE	57
K807-BI	57
K810-MB	57
K811-MB	57
K87-B	53
K87-SN	53
K87	53
K88-B	53
K88	53

ITEM #	PAGE #
K961-DSN	59
KB3-BL	72
KB3-SN	72
KB3	72
KHC-3	206
KHC-6	206
KHC-PREMIUM	206
KHCRA	206
KJSC/D	205
KPL-M	205
KPL-O	205
KR15-BL	69
KR15-C	69
KR15-M	69
KR15-OAK	69
KR15-W	69
KV8070-12	178
KV8070-14	178
KV8070-16	178
KV8070-18	178
KV8070-20	178
KV8070-22	178
KV8070-24	178
L-002-FR-48	194
L-003-FR-48	194
L-003-FR-80	194
L-007-FR-48	194
L-007-FR-80	194
L-8MM-EZ	194
L-8MM-SC	194
L-8MM-WTSC	194
L-EC-002	194
L-EC-003	194
L-MC-003	194
L-MC-007	194
L-PS-FR-3-27	193
L-PS-FR-3-30	193
L-PS-FR-3-40	193
L-PS-FR-3-50	193
L-RMW300-16-27	192
L-RMW300-16-30	192
L-RMW300-16-40	192
L-RMW300-16-50	192
L-RTDK-16-30	192
L-RTDK-16-40	192
L-VMW600-16-27	192
L-VMW600-16-30	192
L-VMW600-16-40	192
L-VMW600-16-50	192
L-VTDK-16-30	192
L-VTDK-16-40	192
LB112	212
LD-0220-50SC	186
LD1270	148
LD2025	148
LD2039	148
LD2200	148
LD228	148
LD250	148

ITEM #	PAGE #
LD262	148
LD300	148
LED25-1-BL	196
LED25-1-BR	196
LED25-2-BL	196
LED25-2-BR	196
LED25-3-BL	196
LED25-3-BR	196
LH-DKDB	205
LHR-16D	195
LS-18	149
LS5-AB	149
LS5-BP	149
LT8700	155
LZ-BF	157
LZ-BTL	157
LZ12	157
LZ3	157
LZ4	157
LZ6	157
M-101643	229
M-101646	229
M-101648	229
M-101649	229
M-101651	229
M-101652	229
M-101654	229
M-101655	229
M-172785	221
M-172786	221
M-172787	221
M-172788	221
M-172789	221
M-172790	221
M-172791	221
M-172792	221
M-172793	221
M-172794	221
M-172854	221
M-172855	221
M-172857	221
M-173142	221
M-173434	221
M-174565	221
M100487-2 1/2"	227
M100487-2"	227
M100487-3"	227
M100487-4"	227
M100487-6"	227
M100487-8"	227
M100487-9"	227
M101721	228
M101814	228
M103279	225
M103280	225
M103281	225
M103282	225
M103301	225
M103303	225

ITEM #	PAGE #
M103304	225
M103527	225
M103528	225
M103531	225
M103534	225
M106288	224
M106289	224
M106291	224
M106294	224
M106296	224
M106306	224
M106307	224
M106308	224
M106309	224
M106310	224
M106312	224
M106314	224
M106316	224
M106318	224
M107216	225
M107218	225
M107219	225
M107221	225
M107253	225
M107257	225
M107258	225
M107321	225
M107323	225
M107325	225
M107326	225
M107407	225
M107411	225
M107414	225
M107416	225
M119564	223
M119565	223
M119566	223
M119567	223
M119568	223
M119569	223
M12	161
M128366	222
M128880	222
M128930	222
M129437	222
M129438	222
M129500	222
M129501	222
M129502	222
M130024	222
M130480	225
M130557	222
M130558	222
M130565	222
M130566	222
M130589	222
M130590	222
M130591	222
M130617	222

ITEM #	PAGE #
M130652	222
M130653	222
M130654	222
M130798	225
M130799	225
M130810	225
M131726	222
M132109	225
M132110	225
M132617	222
M132618	222
M132979	225
M133907	229
M133908	229
M133909	229
M133910	229
M133911	229
M133912	229
M133913	229
M133914	229
M133915	229
M133916	229
M134339	222
M134340	222
M135192	225
M135662	229
M135663	229
M137371	225
M137374	223
M137408	223
M137445	223
M137817	223
M138379	223
M138430	223
M138513	223
M138514	223
M138830	224
M138831	224
M138832	224
M138833	224
M138834	224
M138835	224
M138836	224
M138837	224
M138838	224
M138839	224
M138840	224
M138841	224
M138842	224
M138843	224
M138844	224
M138845	224
M138859	223
M138869	223
M138870	223
M138871	223
M138872	223
M138885	223
M139149	223

ITEM #	PAGE #
M139353	222
M139354	222
M139355	222
M139356	222
M139357	222
M139509	223
M140069	223
M140333	223
M141245	222
M141246	222
M141468	222
M141816	225
M142988	222
M143636	223
M143637	223
M143638	223
M143770	221
M144182	223
M144186	221
M144187	221
M144321	223
M144513	221
M144666	223
M144703	221
M144704	221
M144705	221
M144706	221
M144718	223
M144829	223
M144873	223
M145429	222
M145430	222
M145880	225
M145944	221
M146177	221
M146178	221
M146207	221
M147011	222
M149115	224
M178076	225
M319-6000	207
M319-6005	207
M319-6006	207
M319-6007	207
M319-6008	207
M319-6009	207
M319-6010	207
M319-6011	207
M319-6012	207
M319-6013	207
M319-6014	207
M319-6016	207
M319-6017	207
M6-AB	74
M6-BL	74
M6-SN	74
M671	89
M674	89
M677	89



ITEM #	PAGE #
M679	89
M682	89
M742-2000	206
M742-2002	206
M742-2005	206
M742-2006	206
M742-2007	206
M742-2008	206
M742-2009	206
M742-2011	206
M742-2012	206
M742-2020	206
M743-1500	207
M743-1510	207
M743-1520	207
M743-1530	207
M743-1540	207
M743-1550	207
M743-1560	207
M743-1570	207
M743-1575	207
M743-1580	207
M743-1585	207
M743-1590	207
M745-1330	206
M745-1431	206
M745-1433	206
M745-1435	206
MAX-12	165
MAX-15-B	165
MAX-15	165
MAX-18-B	165
MAX-18	165
MAX-21-B	165
MAX-21	165
MAX-9	165
MAX-EURO-BKT	165
MAX-FLD-LH	165
MAX-FLD-RH	165
MB1/2-M	201
MB1/2-O	201
MB3/8-C	201
MB3/8-M	201
MB3/8-O	201
MB3/8-W	201
MB8310-014	171
MB8310-125	171
MC206	150
MC23	150
MC25-BR	150
MC255-BL	150
MC26	150
MC265-BR	150
MC27	150
MC50760	150
MGS	200
MH1	162
ML-1CH	151
MM10	154

ITEM #	PAGE #
MM18-A-BL	160
MM18-AC	160
MM18	160
MM18A-AC	160
MM18A-N	160
MM18A	160
MM18R-AC	160
MM18R	160
MM18RA-AC	160
MM18RA	160
MM19-AC	160
MM19-BL	160
MM19-N	160
MM19	160
MM19A-AC	160
MM19A-BL	160
MM19A-N	160
MM19A	160
MM5-B	74
MO6303	94
MO6373-128	94
MO6373-12	94
MO6373-160	94
MO6373-18	94
MO6373	94
MPC1	205
MPC2	205
MRS	200
MS48	162
MS60	162
MSL-792	151
MSL-798	151
N144599	223
NCS14012G	220
NCS14034G	220
NCS14058G	220
NCS14078G	220
NCS14100G	220
NCS14112G	220
NCS14114G	220
NCS14118G	220
NCS14138G	220
NEX-290-90-0215	171
NEX-290-91-0015	171
NEX-290-91-0215	171
NEX-290-91-0415	171
NEX-304-54-1515	170
NEX-322-53-0015	170
NEX-322-53-0815	170
NEX-322-54-0015	170
NEX-322-54-1815	170
NEX-493-71-0015	171
NEX-493-71-0215	171
NEX-493-71-0415	171
NEX-493-71-0815	171
NEX-604-51-1515	170
NEX-622-50-0015	170
NEX-622-50-0815	170
NEX-765-53-0015	170

ITEM #	PAGE #
NEX-765-53-0815	170
NEX-765-54-0015	170
NEX-765-82-0815	170
NEX-PIE	170
NEX200.40.0115	171
NICKEL	169
NIGHT	169
OA10-C	200
OA10-M	200
OA10-O	200
OA11-C	200
OA11-M	200
OA11-O	200
OA3-C	200
OA3-M	200
OA3-O	200
OA6-C	200
OA6-M	200
OA6-O	200
OA9-C	200
OA9-M	200
OA9-O	200
OAF1	200
OAF2	200
OAF3	200
OAF4	200
OGS	200
OP3/8-C	201
OP3/8-M	201
OP3/8-O	201
ORS	200
OSP1	201
OSP2	201
OSP3	201
OSP4	201
OSP5	201
OSP6	201
OSP7	201
OSP87	201
OSP88	201
P-100659	227
P-100687	227
P-100688	227
P-100690	227
P-101450	227
P-101757	227
P-101RM	227
P-104395	229
P-104396	229
P-104397	229
P-104398	229
P-104399	229
P-104400	229
P-104401	229
P-1044402	229
P-104504	226
P-104505	226
P-104506	226
P-104507	226



ITEM #	PAGE #
P-104508	226
P-104509	226
P-104510	226
P-104511	226
P-104512	226
P-104513	226
P-104521	226
P-104522	226
P-104523	226
P-104523	226
P-104528	226
P-104529	226
P-104530	226
P-104531	226
P100241	224
P100714	226
P100715	226
P100728	226
P100732	226
P101419	228
P101452	228
P101498	228
P101743	228
P102438	226
P102516	228
P102518	228
P102556	226
P105552	228
P105553	228
P106	140
P2014	88
P2023	88
P2140	80
P2141	80
P2142	80
P2143	80
P2144	80
P2150	86
P2151	86
P2152	86
P2153	86
P2155	90
P2163	82
P2164	82
P2165	82
P2170	87
P2171	87
P2172	87
P2173	87
P2174	87
P2175	90
P220	68
P225	68
P226	68
P2280	84
P2281	84
P2282	84
P2283	84
P2286	84

ITEM #	PAGE #
P271-3-WH	139
P271-96-WH	139
P2712	83
P2921	84
P2922	84
P3000	88
P3001	88
P3002	88
P3003	88
P3004	88
P3010	86
P3011	86
P3013	86
P3014	86
P3015	86
P3041	81
P3060	87
P3061	87
P3062	87
P3063	87
P3064	87
P3100-OBH	85
P3100-SN	85
P3103-OBH	85
P3103-SN	85
P3104-OBH	85
P3104-SN	85
P3111	88
P3112	84
P3114	84
P321	89
P3230	89
P3231	89
P3232	89
P326	89
P329	89
P3370	81
P3371	81
P3373	81
P3374	81
P3375	81
P3448	84
P3562	86
P3563	86
P3564	86
P3565	86
P721006-B	147
P7522	84
P7523	84
P7525	87
P7526	87
P7527	87
P7528	87
P7529	87
P8049	89
PA0213	84
PA0221	84
PA1217	83
PA1218	83

ITEM #	PAGE #
PA1311	88
PA1312	88
PA1321	88
PA1322	88
PA1323	88
PB2-2U-HD	197
PB2-2U	197
PFC-1/2	155
PFC-5/8	155
PG1-2U	197
PGR1	161
PGR2	161
PLMAX-33	210
PLMAX-43	210
PLMAX-48	210
PLSK224	180
PLSK228	180
PLSK232	180
PLSR218	180
PLSR224	180
PLSR228	180
PLSR2318	180
PMR1	161
PS1	153
PS12	153
PS13	153
PS14-GR	153
PS14	153
PS2	153
PS3-2F	197
PS3	153
PS4	153
PST24-BT	78
PST24-C	78
PST25-BT	78
PST25-C	78
PST26-AT	78
PST26-BT	78
PST26-C	78
PST27-AT	78
PST27-C	78
PT-15	208
PT-29	208
PT-50	208
PT-715	208
PT01	208
PT02	208
PT05	208
PT06	208
PT07	208
PT08	208
PT15-X	208
PT16	208
PT27	208
PT33	208
PT38	208
PT39	208
PUMP	209
Q15-F	71



ITEM #	PAGE #
Q15	71
Q29-AE	72
Q29-BL	72
Q29-ORB	72
Q29-SN	72
Q29	72
Q30	71
Q31	72
Q32-BL	72
Q33	72
Q34	71
Q351-A	72
Q351-B	72
Q351	72
Q4-F	71
Q4	71
Q96-BL	72
Q96-ORB	72
Q96-SN	72
QA15-C	204
QA15-M	204
QA15-O	204
QA21-C	204
QA21-M	204
QA21-O	204
QA29-C	204
QA29-M	204
QA29-O	204
QUIK-BIT	205
R1-AE	150
R1-BL	150
R1-PB	150
R10-AB	151
R10-BL	151
R10-PB	151
R6-AB	151
R6-PB	151
RAL-101-1	187
RC125	150
RC126	150
RH-2 X 3/8	148
RH-4 X 3/8	148
RH2	154
RHP-16	159
RHP-24	159
RHP-28	159
RHP-34	159
RL-201-1	187
RL-202-1	187
RV-1024W	186
RV-12PB	186
RV-15PB-2S	186
RV-18PB-2S	186
RV-35-W	186
RV-50-W	186
RV-RAS-ML-HDCR	187
RV-RAS-ML-HDSC	187
RWH08012B	212
RWH08034B	212

ITEM #	PAGE #
RWH08058B	212
RWH08100B	212
RWH08112B	212
RWH08114B	212
RWH08134B	212
RWH08200B	212
RWH08212B	212
RWH08300B	212
RWH10100B	212
RWH10112B	212
RWH10114B	212
RWH10134B	212
RWH10200B	212
RWH10212B	212
RWH10300B	212
S077188	90
S077190	90
S077192	90
S271-128	139
S271-3.5	139
S271-3	139
S271-4	139
S271-96	139
S6060	118
SB-66	159
SB-68	159
SB-810	159
SB20	161
SBF-12	159
SBF-65	159
SBF-9	159
SCD-18971	171
SDH-1301	147
SDH-1324SC	147
SDH-1348	147
SDH-1360	147
SDH-1372	147
SDH-1402	147
SDH-1403	147
SDH-1404	147
SDH-1405	147
SDH-1408	147
SDH-1409W-BL	146
SDH-1409W-ORB	146
SDH-1409W-SN	146
SDH-1419-BL	146
SDH-141W-SS	146
SDH-1424-SC	146
SDH-145WG-SS	146
SDH-688	147
SDH-875	147
SDH-BYPASS	146
SDH-CUSTOM	147
SDH-J150	147
SDH-J34	147
SDH-MINIBYPASS	147
SF1880BL	210
SF1880C	210
SF3120C	210

ITEM #	PAGE #
SF370C	210
SF570C	210
SFT-112-S	189
SFT-142-S	189
SH3	158
SH4	158
SHP-16	159
SHP-24	159
SHP-28	159
SHP-34	159
SML-2HD	151
SML1	151
SML2	151
SMTR-2	151
SQ-6712	213
SQ-6716	213
SQ6076-BL	213
SQ6077-BL	213
SQ74-AB	216
SQ76-AB	216
ST1	162
ST2	162
STMW-ALD	182
STMW-HMP	182
STN1	160
STN4	160
STN6	160
STRAINER-200	183
T-12W-12V-PI	193
T-24W-12V-PI	193
T-36W-12V-PI	193
T-3WSP	194
T-60W-12V-PI	193
T-65	165
T-96W-12V-PI	193
T-BC-EXT-36-BK	194
T-BC-EXT-72-BK	194
T-BC-EXT-96-BK	194
T-CW20	194
T-DSS-30W-IR	193
T-EZWC	194
T-FBC	194
T-MBC	194
T-MSS-60W	193
T-PSS-60W-IR	193
T-Q-4Z-WC-RF	193
T-Q-WR240	193
T-Q-WR96	193
T-TDS-60W	193
T011-REPL	189
T011S-REPL	189
T014-REPL	189
T014S-REPL	189
T101	157
T102-R	157
T103-L	157
T204	157
TB-1414	209
TB-1415	209

ITEM #	PAGE #
TB-1416	209
TB-31197	209
TB-50009	209
TB-5004	209
TB-5005	209
TB-5006	209
TB-5007	209
TB-50609	209
TB-5064	209
TB-5065	209
TB-5066	209
TB-5067	209
TBL1	158
TBL2	158
TBL3	158
TEC-CLIP	166
TEC 02284	166
TEC 02870A	166
TEC 02905	166
TEC 02910A	166
TEC 04396	166
TEC 04399	166
TEC 04400	166
TEC 04401	166
TEC 04429A	166
TEC 04431A	166
TEC 04432A	166
TEC 04441A	166
TEC 04493	166
TEC 04547A	166
TEC 04549A	166
TFE-LUBE	205
TH-0220-SC	189
TH-1164	189
TH-231	148
TH-270	189
TIO-385	167
TIO-386	167
TIO-387	167
TIO-388	167
TIO-414	167
TIO-415	167
TIO-416	167
TIO-417	167
TIO-443	167
TIO-444	167
TIO-457	167
TIO-458	167
TIO-459	167
TIO-460	167
TIO-461	167
TIO-462	167
TIO-463	167
TIO-464	167
TIO-499	168
TIO-500	168
TIO-501	168
TIO-502	168
TIO-503	168

ITEM #	PAGE #
TIO-504	168
TIO-517	168
TIO-519	167
TIO-520	167
TIO-521	167
TIO-522	167
TIO-523	167
TIO-524	167
TIO-525	167
TIO-526	167
TIO-561	168
TIO-562	168
TIO-563	168
TIO-564	168
TIO-565	168
TIO-566	168
TIO-671	169
TIO-677	169
TIO-746	168
TIO-747	168
TIO-748	168
TIO-749	168
TIO-751	167
TIO-825	168
TIO-826	168
TIO-827	168
TIO-828	168
TIO-831	168
TIO-888	168
TIO-892	168
TIO-893	168
TIO-894	168
TIO-895	168
TLH-515	158
TOSS11-REPL	189
TOSS11S-REPL	189
TOSS14-REPL	189
TOSS14S-REPL	189
TS-2437	156
TS-2625	156
TS-2838	156
TS-3650	156
TS-3837	156
TS-4443	156
TS-4847	156
TS-5049	156
TTHP-16	159
TTHP-24	159
TTHP-28	159
TTHP-34	159
TUBE65	145
UB-21216	159
UB-21224	159
UB-21228	159
UB-21234	159
UB-31816	159
UB-32628	159
UB-42628	159
UCCB	189

ITEM #	PAGE #
UFS010114B	213
UFS010200B	213
UFS010212B	213
UFS06034B	213
UFS06100B	213
UFS06112B	213
UFS06114B	213
UFS08100B	213
UFS08112B	213
UFS08114B	213
UFS08134B	213
UFS08200B	213
UFS08212B	213
UFS08300B	213
UFS10312B	213
UNIV-7950.VE300	165
UNIV-7950	164
UNIV-7951.	164
USF06058B	213
UT-10*-52	188
UT-12*-52	188
UT-15*-52	188
UT-18*-52	188
V0128-AB	74
V0128-DBAC	74
V0128-MB	74
V0128-SN	74
V0138-DBAC	74
V0138-MB	74
V0138-SN	74
V0148-AB	74
V0148-DBAC	74
V0148-MB	74
V0148-SN	74
V100-BZ	77
V103841	162
V10	75
V11-AB	75
V116-AE	77
V116-PB	77
V120-BL	76
V120-NI	76
V120-RB	76
V120-W	76
V120	76
V123	76
V125	76
V126	76
V12	75
V14-PB	75
V148-BL	76
V148-SN	76
V148-WI	76
V149-AE	75
V15-BL	75
V16-AB	75
V170-AB	77
V19-AE	75
V20-DAB	77



ITEM #	PAGE #
V2010-BL	77
V201008	176
V2010	77
V203351	176
V21-AB	76
V22-AB	76
V22A-AB	76
V25-AE	75
V25-BL	75
V26-BP	148
V26A-BP	148
V28-PB	148
V28A-BL	148
V28A-PB	148
V29-BP	148
V29A-AB	148
V29A-BL	148
V29A-BP	148
V30-AE	75
V301008	176
V32-AE	75
V50-DAB	77
V73-A	75
V73-BL	75
V74-BL	77
V74-PB	77
V76-BL	77
V9005	162
V9313	162
V9314	162
V9315	162
V9317	162
VBF10	74
VS-BIT	145
WARNING LABEL	162
WC10-A	203
WC10-C	203
WC10-E	203
WC10-H	203
WC10-M	203
WC10-Q	203
WC10	203
WC16-A	203
WC16-C	203
WC16-E	203
WC16-H	203
WC16-M	203
WC16-Q	203
WC16	203
WC6-A	202
WC6-C	202
WC6-E	202
WC6-H	202
WC6-M	202
WC6-Q	202
WC6	202
WC7-A	202
WC7-C	202

ITEM #	PAGE #
WC7-E	202
WC7-H	202
WC7-M	202
WC7-Q	202
WC7	202
WC8-A	202
WC8-C	202
WC8-E	202
WC8-H	202
WC8-M	202
WC8-Q	202
WC8	202
WC9-10	203
WC9-10A	203
WC9-10C	203
WC9-10E	203
WC9-10H	203
WC9-10M	203
WC9-10Q	203
WCC1-C	203
WCC1-H	203
WCC1-M	203
WCC1-Q	203
WCC1	203
WCM7-A	203
WCM7-C	203
WCM7-E	203
WCM7-H	203
WCM7-M	203
WCM7-Q	203
WCM7	203
WD10	158
WD12	157
WD15	158
WD21	158
WD50	157
WPC-1	197
WPC52T	197
WR30-2ALD	182
WR30-2MP	182
WR30-2OK	182
WR30MP	182
WR36MP	182
WR45-2ALD	182
WR45-2MP	182
WR45-2OK	182
WR48-2ALD	182
WR48-2MP	182
WR48-2OK	182
WTER1-BL	196
WTER1-BR	196
WTER2-BL	196
WTER2-BR	196
WTER3-BL	196
WTER3-BR	196
x-1216	159
x-1816	159

ITEM #	PAGE #
X-2628	159
X721900	147
Xantitip	162
YBIT23LP	211
YBIT23LS	211
YBIT23SP	211
YBIT23SS	211
Z11-A	152
z110	100
Z110	99
z111	100
Z11	152
Z115-128	133
Z115-96	133
Z115	133
Z115L	133
Z117-DACM	55
Z117-DBN	55
Z117-SIM	55
Z117	109
Z118-3	129
Z118-96	129
Z118	129
Z12-A	152
Z12-B	152
Z12-HD	152
Z12	152
Z12B-HD	152
Z13-HW	152
Z13-ST	152
Z14-A-AB	152
Z14-A	152
Z14-AB	152
Z14-BL	152
Z14	152
Z205	128
Z259-12	133
Z259-3	133
Z259-BL	59
Z259-SN	59
Z260-12	118
Z260-3	118
Z261-128	118
Z261-96	118
z280	100
z281-12	100
z281-128	100
z281-160	100
z281-18	100
z281	100
Z290-12	102
Z290-128	102
Z290-160	102
Z290-3	102
Z290-96	102
Z500-128	128
Z718-12	105



## For Buckeye Hardware Orders Please Contact:

FAX ORDER LINE

PHONE

330-897-0022

330-897-0017 | 844-303-0017

---

Let us help you personalize your furniture with a nameplate.

We can do any logo nameplate. Give us a call or send us your logo for a quote!

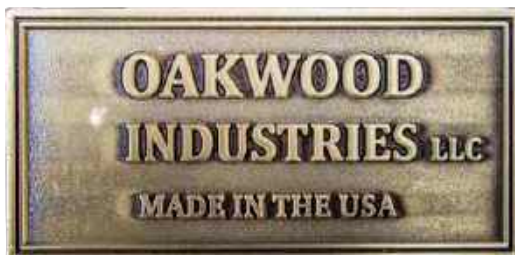

Catalog proudly designed and printed by:



SCHLABACH PRINTERS

[schlabachprinters.com](http://schlabachprinters.com)



*Buckeye*  
**HARDWARE**  
DISTRIBUTING, LTD.

330-897-0017 | fax orders 330-897-0022  
1465 Township Road 178 • Baltic, Ohio 43804

